

# PG&E's Distribution Resources Plan Webinar

August 3, 2015



# Safety Message

## Emergency Preparedness

- Awareness of your surroundings
- Emergency Number
- “Duck and Cover”
- CPR and First Aid
- Exit Routes and Evacuation Process
- Gathering Points

# Purpose of Webinar

Provide deep dive into PG&E's Distribution Resources Plan that was filed with the Commission on July 1, 2015.

- Protests and responses due on **August 31, 2015**
- Replies to protests and responses due on **September 15, 2015**
- Prehearing Conference on **September 23, 2015**

# Agenda

---

<b>9:30 am – 9:40 am</b>	<b>Welcome and Introduction</b> <ul style="list-style-type: none"><li>• Background on AB 327 &amp; Commission Guidance</li><li>• PG&amp;E's Policy and Vision</li></ul>
<b>9:40 am – 10:40 am</b>	<b>Final Guidance Requirement 1</b> <ul style="list-style-type: none"><li>• Integration Capacity Analysis</li><li>• Optimal Location Benefit Analysis</li><li>• DER Growth Scenarios</li></ul>
<b>10:40 am – 10:55 am</b>	<b>Q&amp;A Session on Final Guidance Requirement 1</b>
<b>10:55 am – 11:20 am</b>	<b>Final Guidance Requirements 2 – 5</b> <ul style="list-style-type: none"><li>• Demonstration and Deployment</li><li>• Data Access</li><li>• Tariffs and Contracts</li><li>• Safety Considerations</li></ul>
<b>10:20 am – 11:30 am</b>	<b>Q&amp;A Session on Final Guidance Requirements 2 – 5</b>
<b>11:30 am – 11:45 am</b>	<b>Final Guidance Requirements 6 – 9</b> <ul style="list-style-type: none"><li>• Barriers to Deployment</li><li>• DRP Coordination with Utility and CEC Load Forecasting</li><li>• DRP Coordination with Utility General Rate Case</li><li>• Phasing of Next Steps</li></ul>
<b>11:45 am – 11:55 am</b>	<b>Q&amp;A Session on Final Guidance Requirements 6 – 9</b>

---

---

# AB 327 Added PUC Code Section 769

- Distributed Energy Resources (DER) means:



Distributed  
Renewable  
Generation

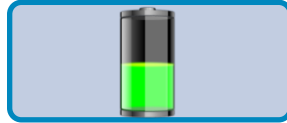

Energy  
Storage



Energy  
Efficiency



Demand  
Response



Electric  
Vehicles

- **Submit a distribution resources plan proposal to the CPUC by July 1, 2015**
  - Evaluate locational benefits and costs of DERs located on distribution system. This evaluation shall be based on reductions or increases in local generation capacity needs, avoided or increased investments in distribution infrastructure, safety benefits, reliability benefits, and any other savings the distributed resources provide to the electrical grid or costs to ratepayers of the electrical corporation.
  - Recommend standard tariffs, contracts, or other mechanisms for deployment of cost-effective DER
  - Propose effective coordination of existing commission-approved programs, incentives, and tariffs to maximize DER locational benefits
  - Identify additional utility spending to integrate cost effective DER into Distribution Planning to yield net benefits to ratepayers
  - Identify barriers to deployment of DER, including, but not limited to, safety standards related to technology or operation of the distribution system in a manner that ensures reliability

# DRP Objectives

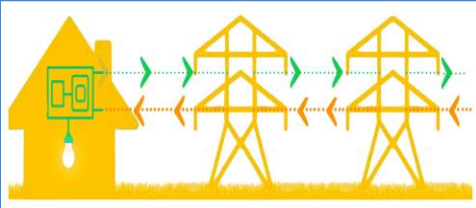

Modernize distribution system to accommodate expected DER growth through two-way power flow



Enable customer choice of new electric DER technologies and services



Identify and develop opportunities for DERs to realize grid benefits

**Identify Optimal Locations for deployment of DERs**

# DRP Content

- Policy and Vision
- Distribution Resources Planning Methodologies
- Integration Capacity
- Locational Benefit and Costs
- DER Growth Scenarios
- Demonstration and Deployment
- Data Access and Sharing
- Tariffs and Contracts
- Safety Considerations
- Barriers to Deployment
- DRP Coordination with GRC
- DRP Coordination with Utility and CEC Forecast
- Phasing of Next Steps (Future DRP cycles)

# PG&E's DRP Policy and Vision

- DRP will enable significant DER integration and supports California's Clean Energy Vision
- PG&E's role is essential to achieving California's goals for safe, clean, affordable, reliable and resilient energy
- PG&E's initial DRP serves as the technical foundation for integrating DERS focusing on:
  - Interconnection and integration efficiency
  - Transparent locational benefits and costs evaluation
  - Development of short & long-term scenarios of capacity and resource needs
  - Effectively managing overlapping initiatives
  - Fair and transparent processes for DER deployment and integration
- Achieving the long term DRP vision requires significant and coordinated electricity pricing reform





# PG&E's Initial DRP serves as Technical Foundation for Integrating DERs into Planning and Operations

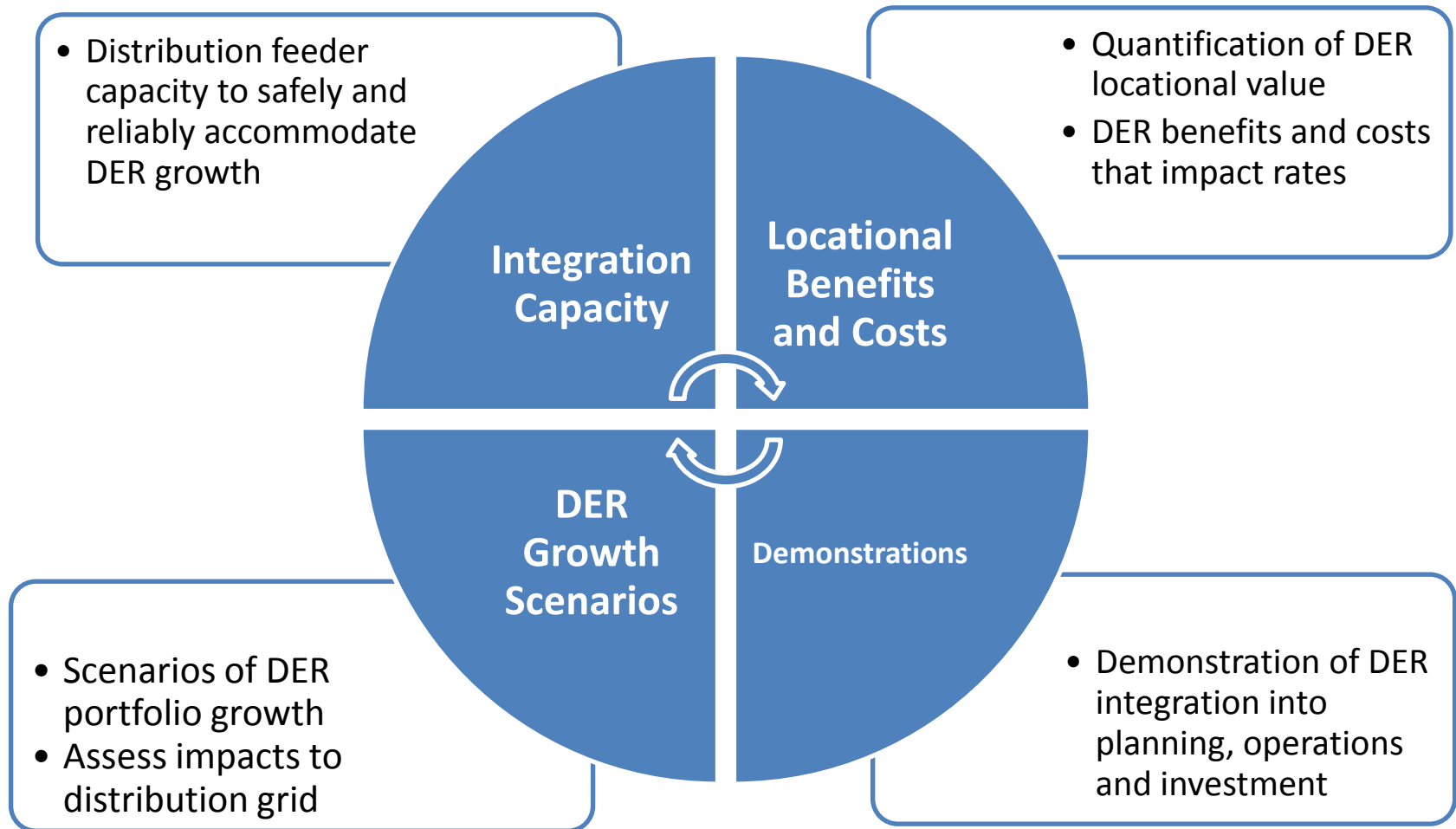

# Integration Capacity Analysis and Methodology

# PG&E Distribution System



## Distribution System Metrics

- **20 Electric Planning Divisions**
  - 245 Electric Planning Areas
  - 70,000 sq. miles with diverse topography
  - 5.5 million electric customers
  - 142,000 miles of distribution lines
- **785 Distribution Substations**
  - 1,300 Substation Distribution Transformers
  - 3,300 Distribution Circuit Breakers
- **3,000 Distribution Feeders**
  - 1 Million Distribution Line Transformers
  - 2 Million Nodes/Line Segments Modeled
  - 7,000 Line Reclosers
  - 150,000 Fuses
  - 2,300 Voltage Regulators
  - 12,000 Capacitor Banks

*NOTE: Above metrics are approximates based on 2015 Q1 data*

# New Methodology to Determine Locational DER Capacity

## New methodology was required to be developed to calculate DER Integration Capacity

- PG&E was instructed to develop a new methodology to help determine locational DER capacities that would not require significant upgrades to interconnect
- Methodology considers important criteria and aspects considered in detailed engineering reviews during interconnection
- Result is capacity values that estimate when significant impacts are not expected and detailed review is not necessary

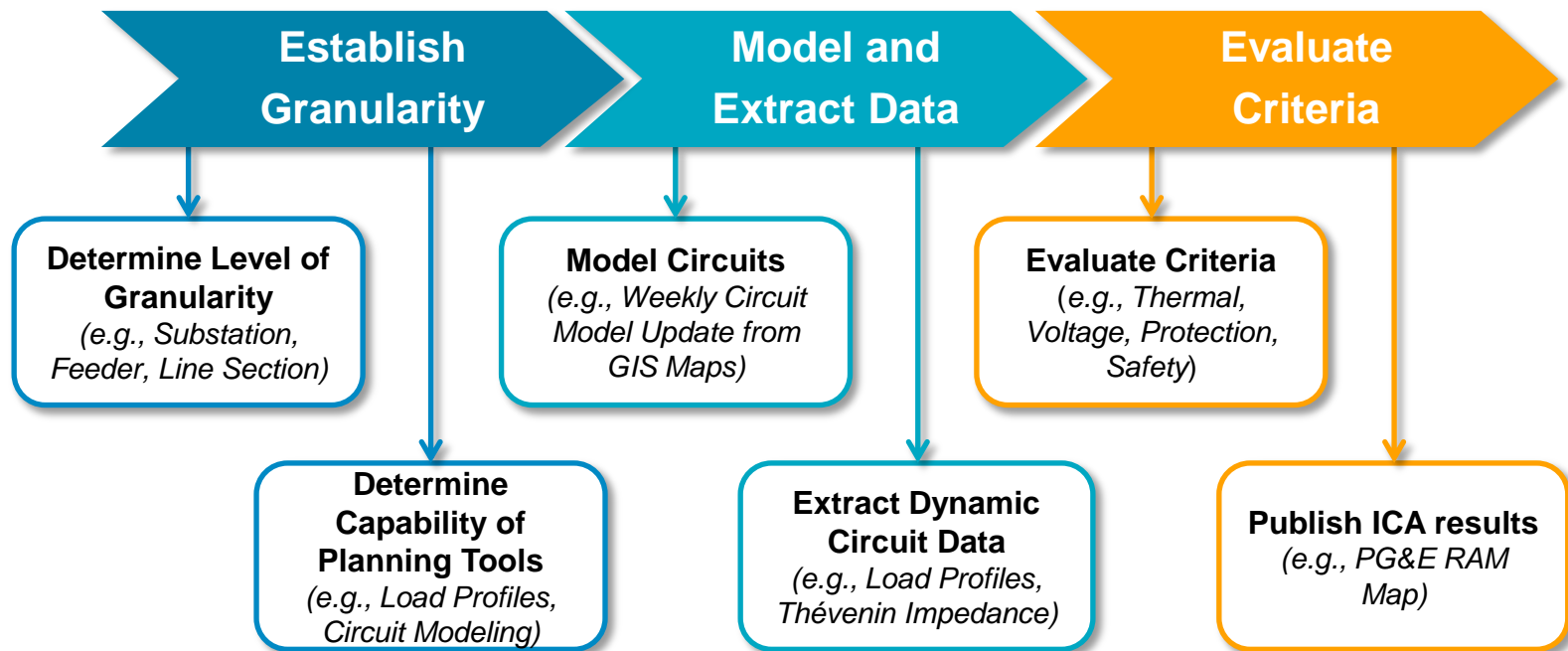
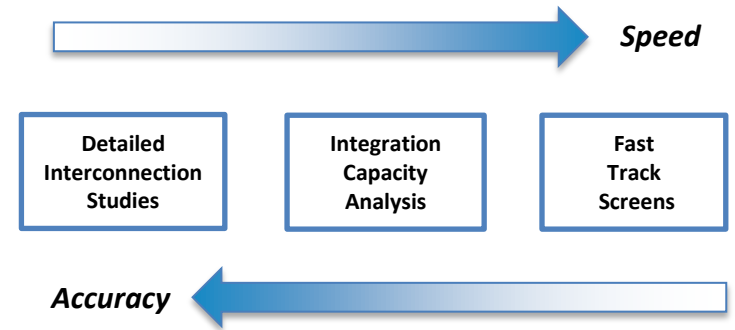

# Granularity of PG&E Integration Capacity Analysis

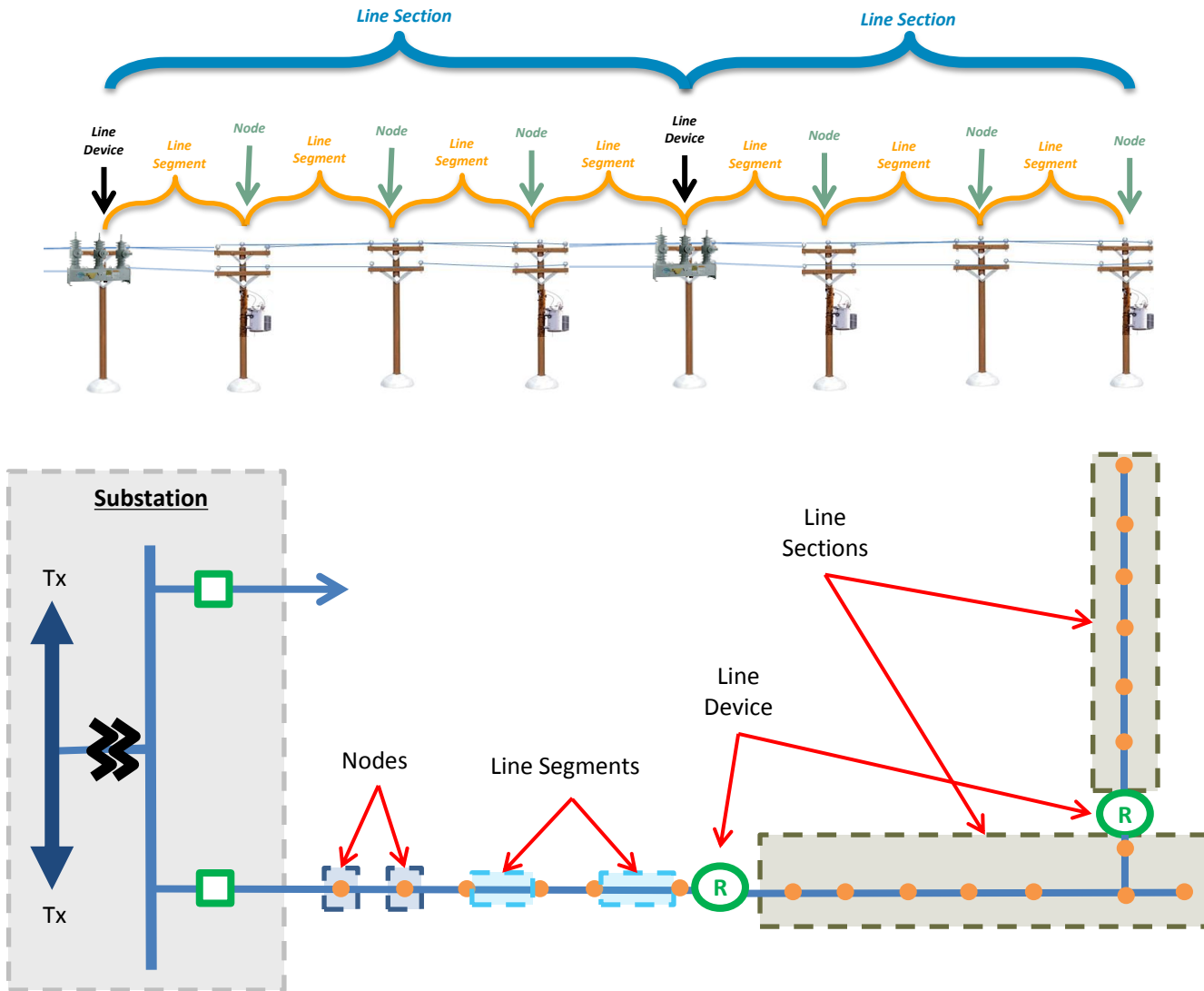

**Analysis was granular down to line sections within each feeder**

- PG&E was able to perform the analysis down a very granular level on specific line sections within each distribution feeder
- This is very important to be able to capture the limiting aspects of the tapered radial distribution system design
- Industry studies and analyses typically only consider or have the ability to do this analysis at the substation level

# Advanced Planning Tools Capabilities

## Utilizes Advanced Planning Tools and Datasets to help perform analysis

- PG&E upgraded its planning tools 3 years ago to enhance the planning process and accuracy
- Load and Generation Hourly Profiles
  - Utilize PG&E's Load Forecast Analysis tool to get representative load profiles for every distribution feeder
  - Compares these profiles against representative DER hourly profiles to determine hourly impact to capacity
  - Tool is LoadSEER developed by Integral Analytics
- Geospatial Distribution Feeder Models
  - Utilizes PG&E's Power Flow Analysis tool to understand the power flow effects on the distribution lines granular down to customer service transformers
  - Utilizes advanced automation scripting features capable with Python
  - Tool is CYMDIST by CYME International

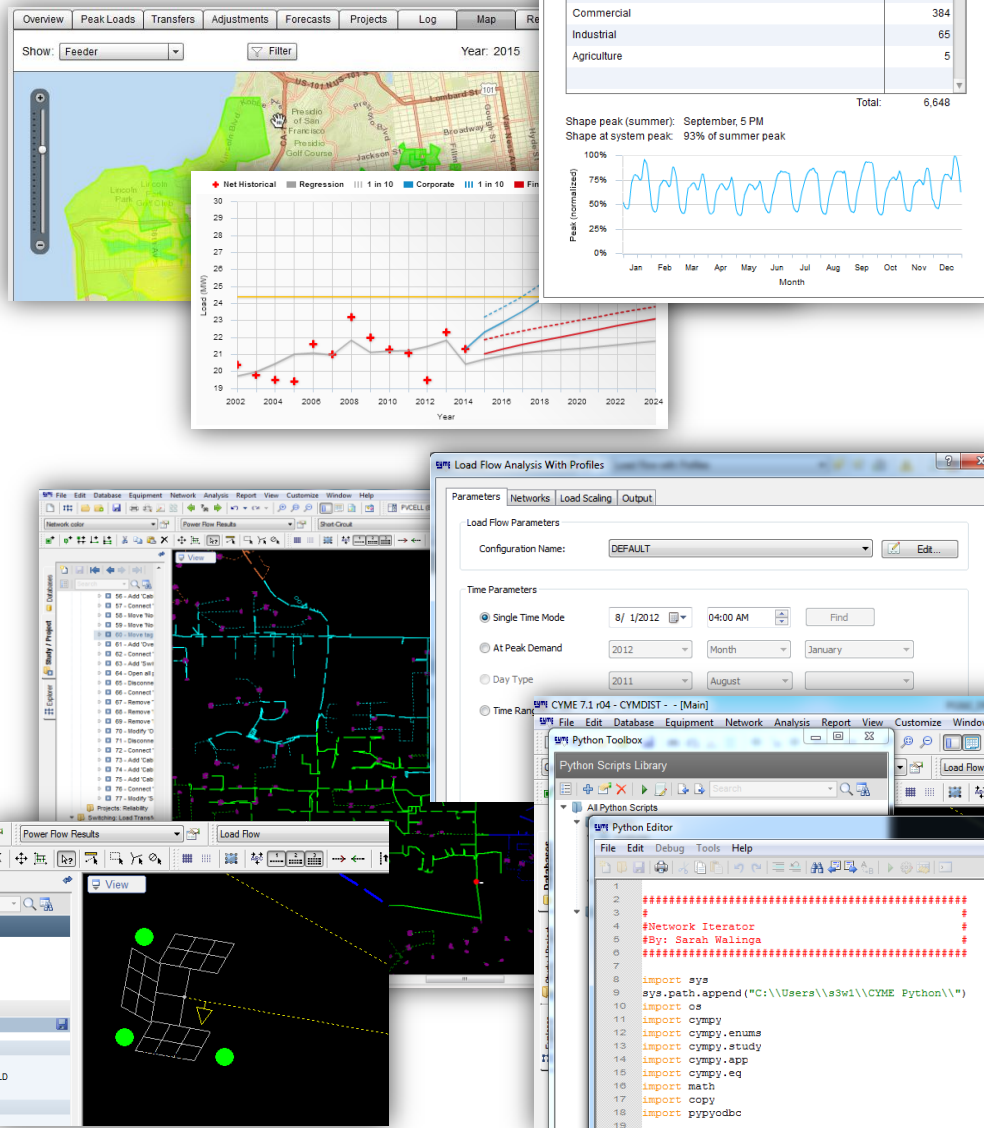

# Modeling Circuits and Extracting Relevant Data

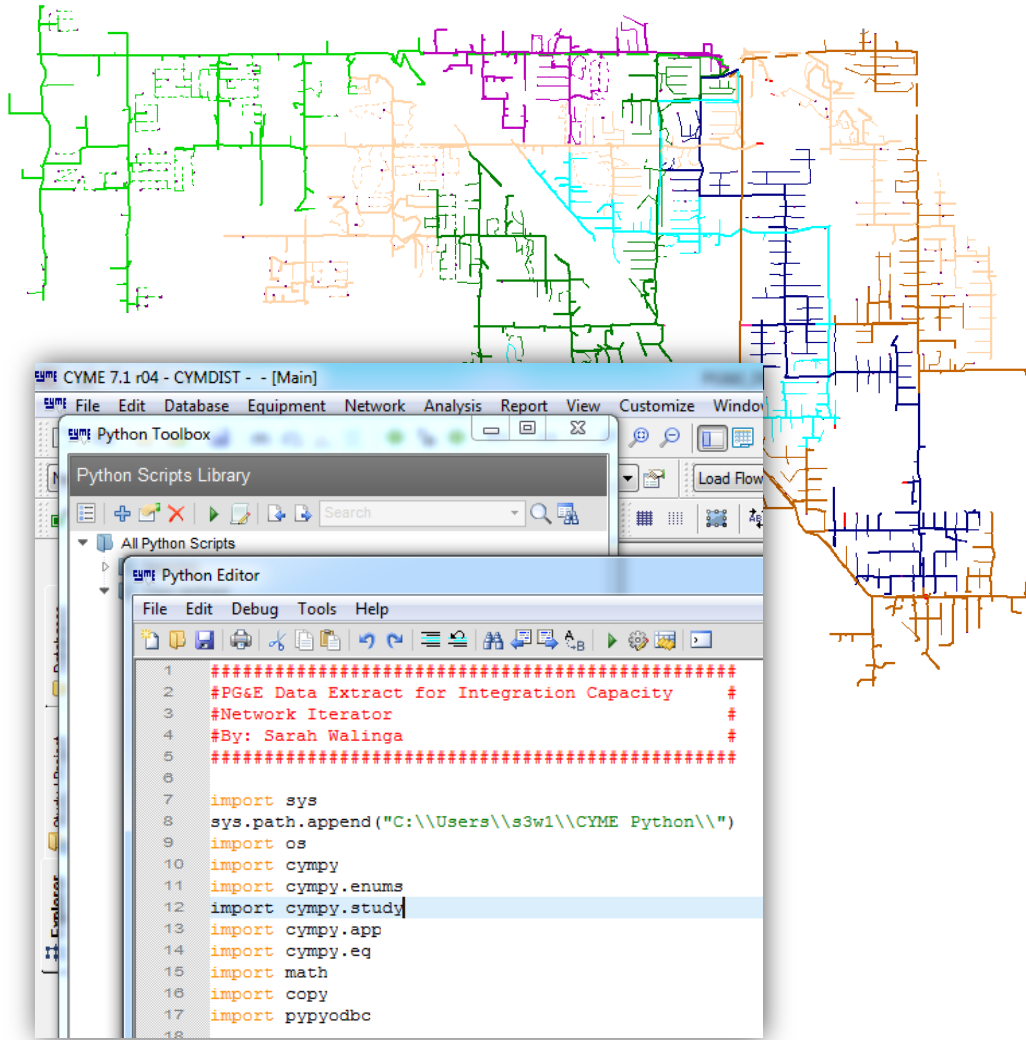

## Modeling distribution circuits in CYME

- Weekly updates to CYME models give PG&E engineers latest distribution circuit configurations based on changes to GIS asset map
- Seasonal power flow planning studies performed in Distribution Planning Process help inform load details for distribution line devices

## Extracting Relevant data using Python

- Custom python scripting was used to extract system data needed for analysis Models
  - Thévenin Impedances
  - Thermal Ratings
  - Upstream devices and conductors
  - Etc.
- Utilizing python script within CYME enables ability to collaborate with CYME/EPRI towards integrating methodology into commercial software

# Time Dynamic Analysis through Hourly Load and DER Profiles

Specific DER technology impact can be determined by utilizing LoadSEER's hourly load profiles

- Representative load profiles are established for every distribution feeder even when there is no SCADA
- Integration Capacity results can be different depending on the DER operating profile and characteristics

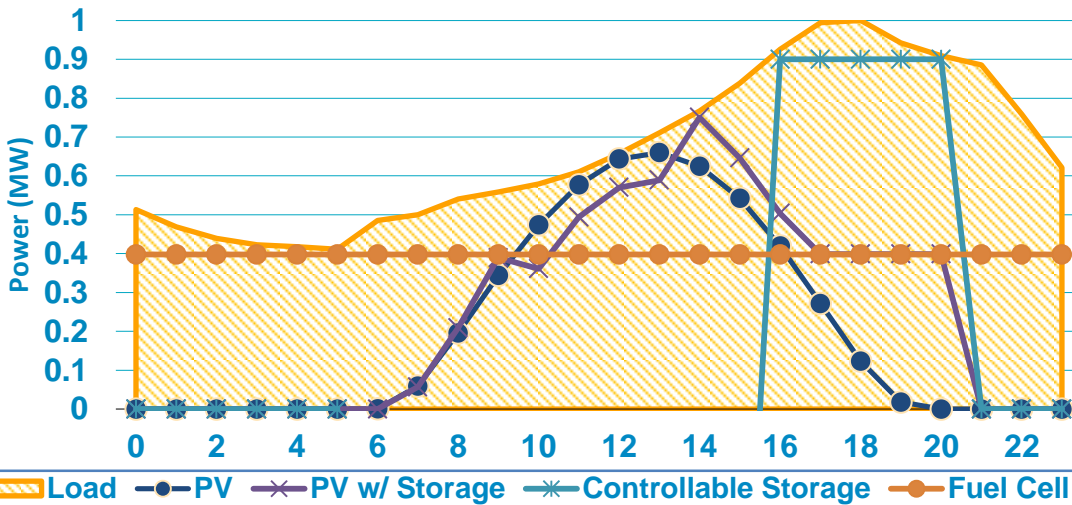
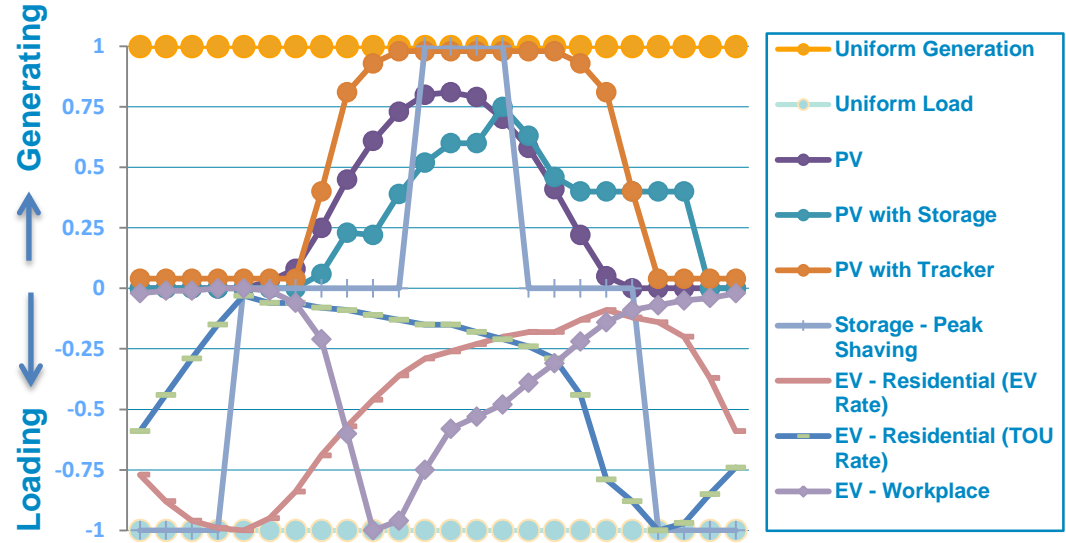

DER	Limiting Hour	Max Capacity
PV	12 PM	0.66 MW
PV w/ Storage	2 PM	0.75 MW
Controllable Storage	4 PM	0.90 MW
Fuel Cell	5 AM	0.40 MW



# Evaluation of Important Power System Criteria

Various aspects of the power system must be analyzed to determine possible impacts

- Thermal
  - Determines limits based on equipment thermal ratings
- Power Quality / Voltage
  - Determines limits that do not create power quality to operate outside prescribed thresholds
- Protection
  - Determines limits that ensure protection equipment can still operate as designed
- Safety / Reliability
  - Determines limits that reduce impacts to safe and reliable operation of the grid during abnormal conditions

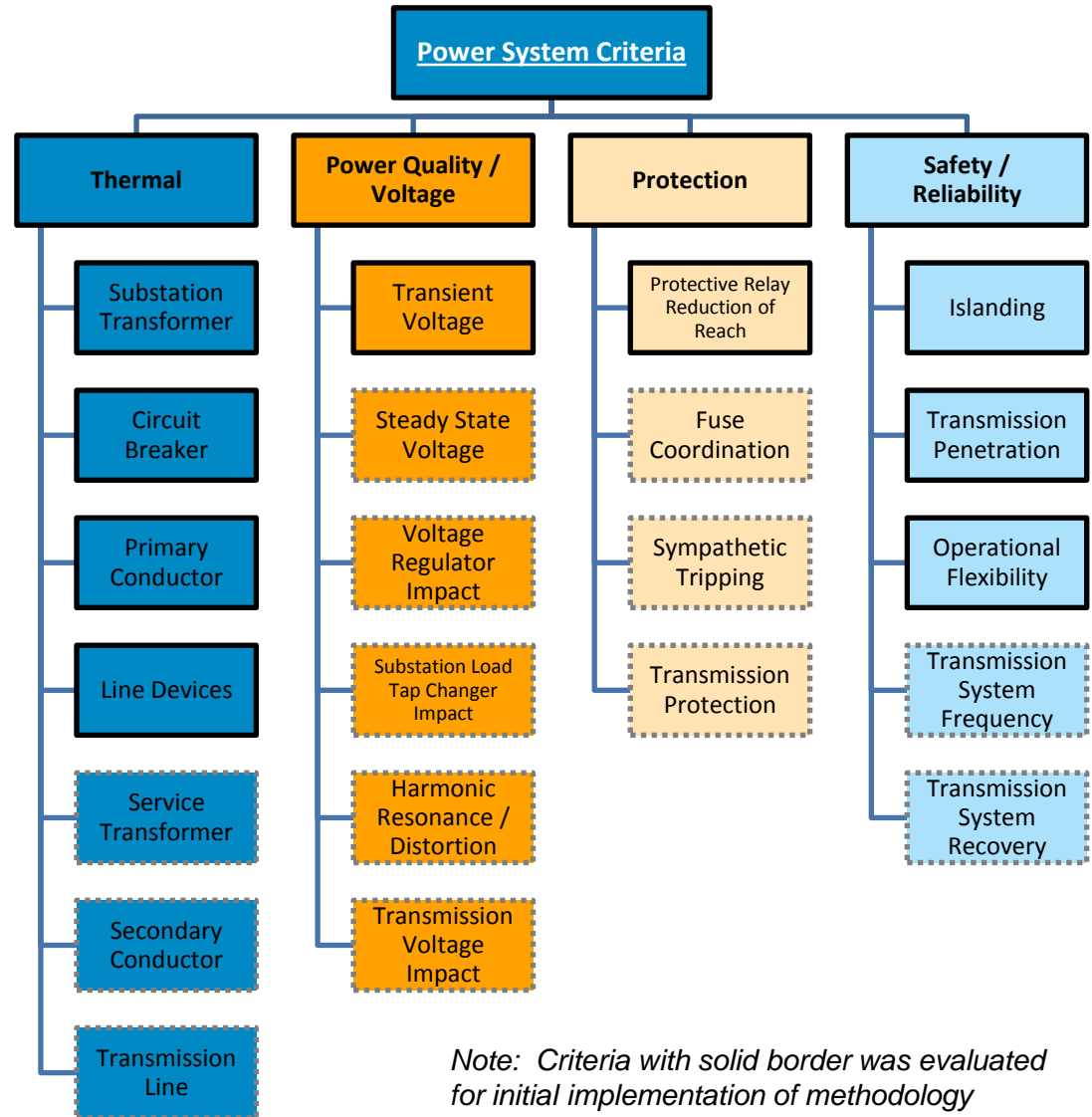

# Flexible Layered Framework

Each criteria limit is calculated for each layer independently and the most limiting values establish the integration capacity limit.

- SQL Server calculates final results for the whole dataset across selected DER types
- Utilizing SQL scripting enables collaboration with Integral Analytics to more easily incorporate methodology into commercial software

Thermal	Power Quality / Voltage
Protection	Safety / Reliability

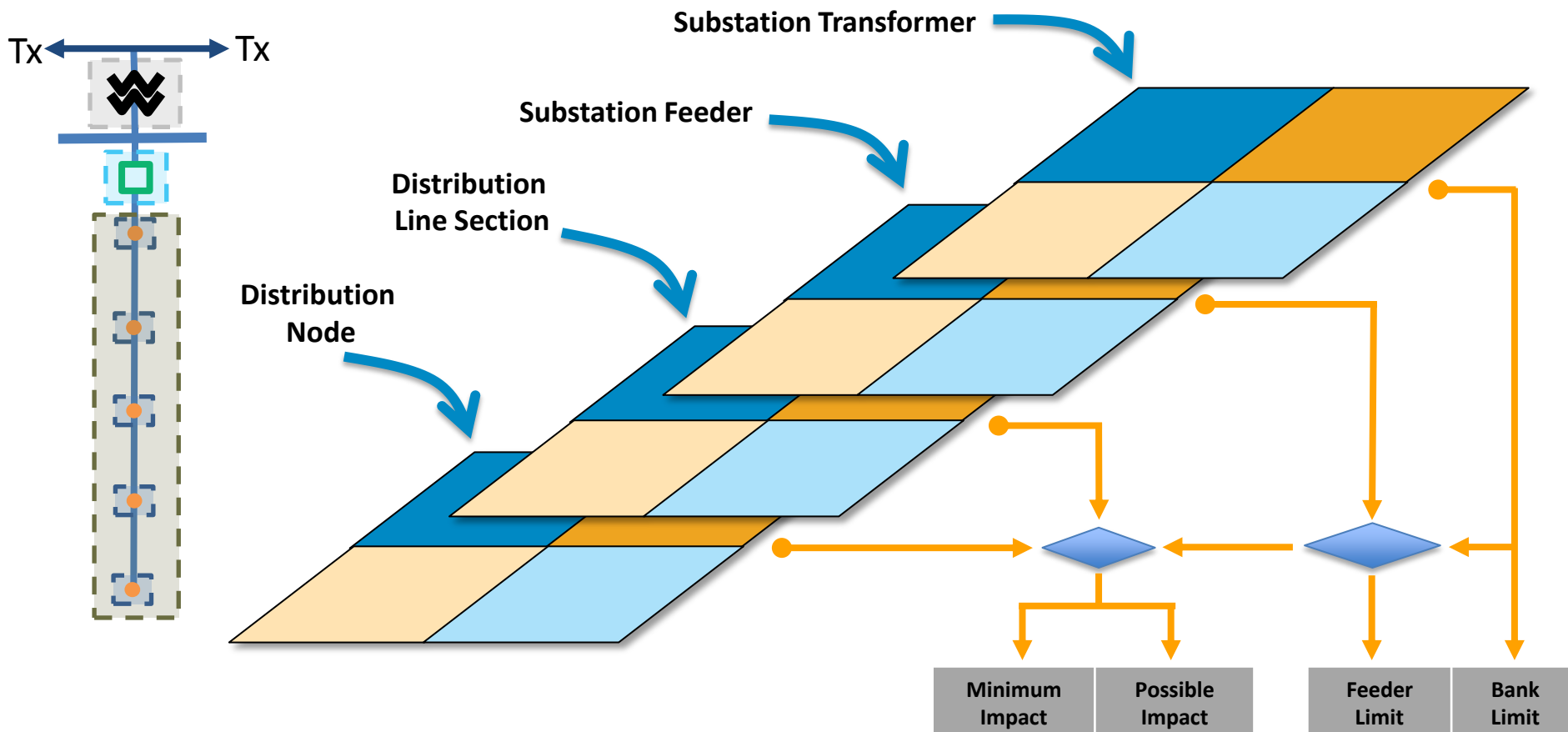

# Publishing Integration Capacity on PG&E RAM Map

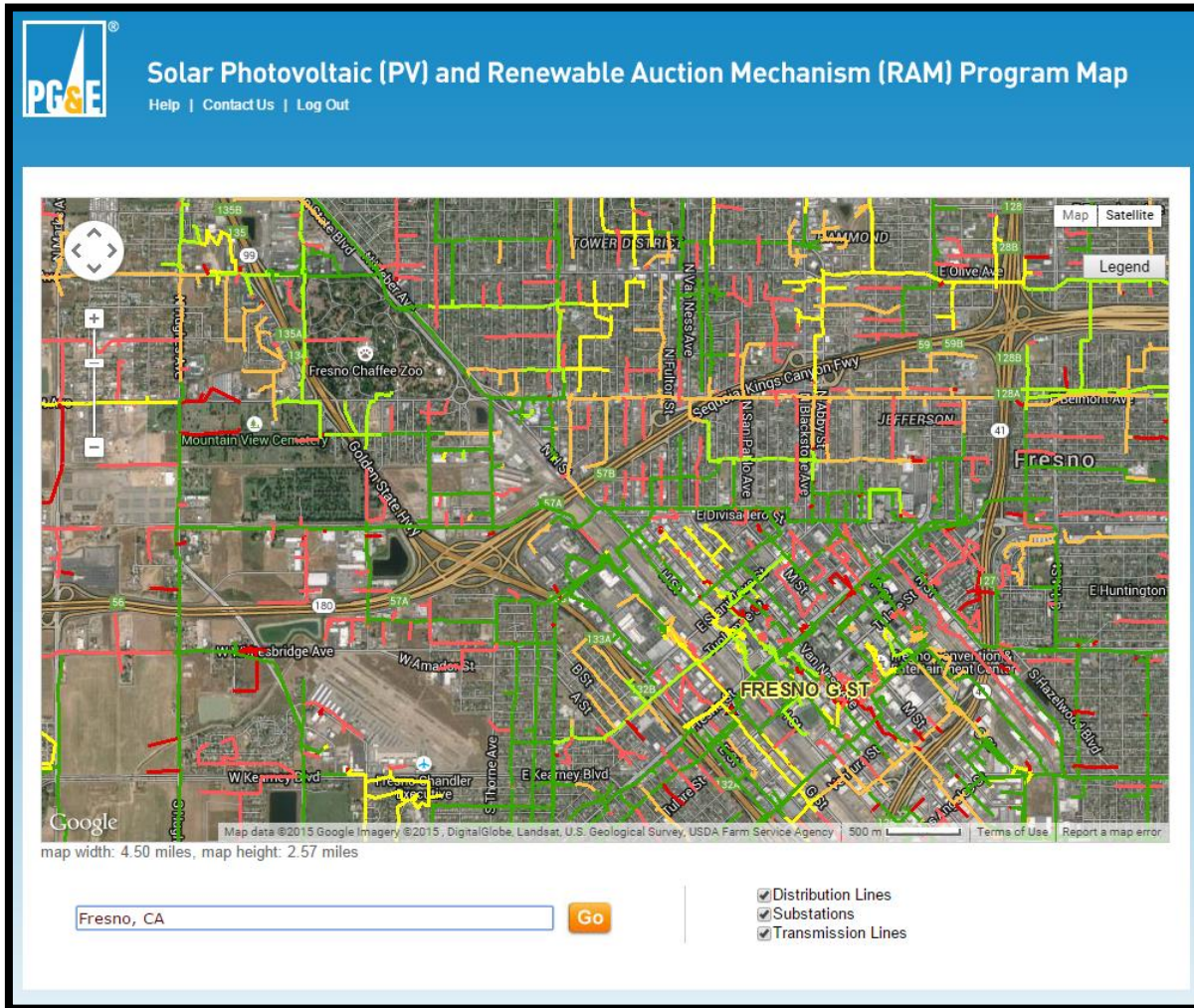

**PG&E analyzed all three phase line sections for all the 3,000+ distribution circuits**

- Results for approx. 102,000 line sections
  - Average of 34 line sections per feeder
  - Largest number of line sections for one feeder was found to be 310
- Locational results published by each DER type
- Granular down to fuse devices
- Initially colored by PV Results
  - Line Section IC / Feeder IC
  - Red, Amber, Green color scheme with green being higher capacities

# Explanation of Integration Capacity Results

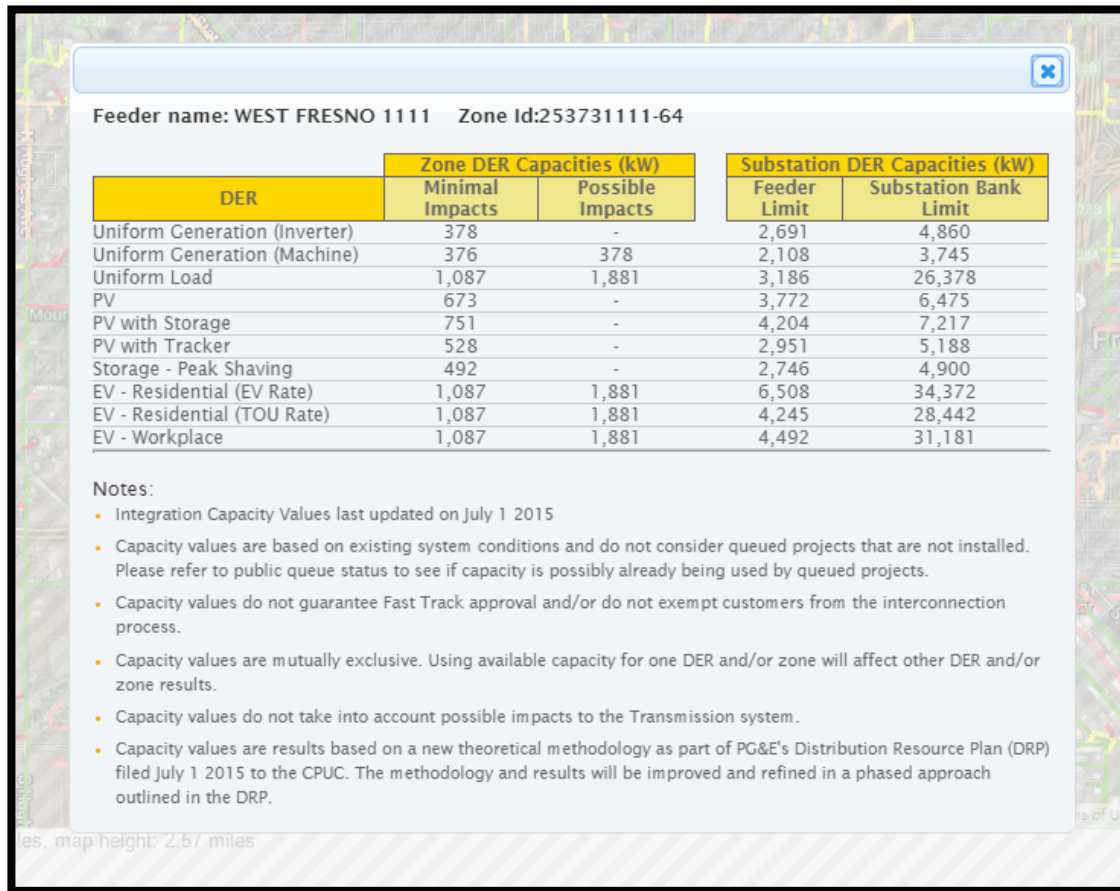

- Provide capacities for 10 different DER types/models
  - “Uniform Generation” and “Uniform Load” types can be used for DER with constant or unspecified profiles
  - The uniform profiles can also be used to understand storage charge and discharge capabilities with unconstrained operation times
- Substation (Bank and Feeder) limits are provided to inform customers that intend to interconnect to multiple line sections on a Feeder and/or Bank
- Line Section Level results provide a range indicating different capacities based on where interconnection on line section
  - Many line section results have little / no difference between the two values because the granularity achieved is quite detailed

# Results Analysis for PV

Typical DER Use Case: Standalone Fixed-Axis PV

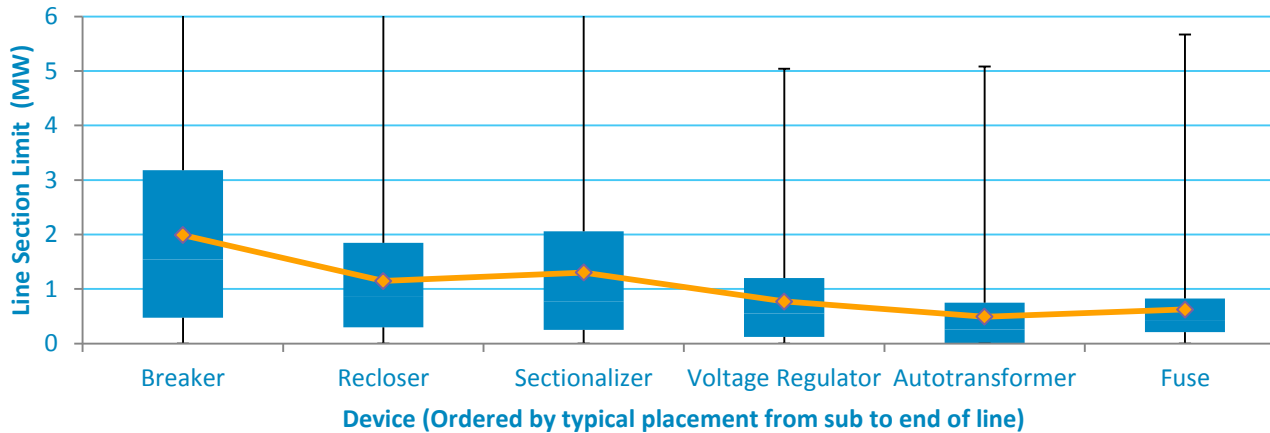
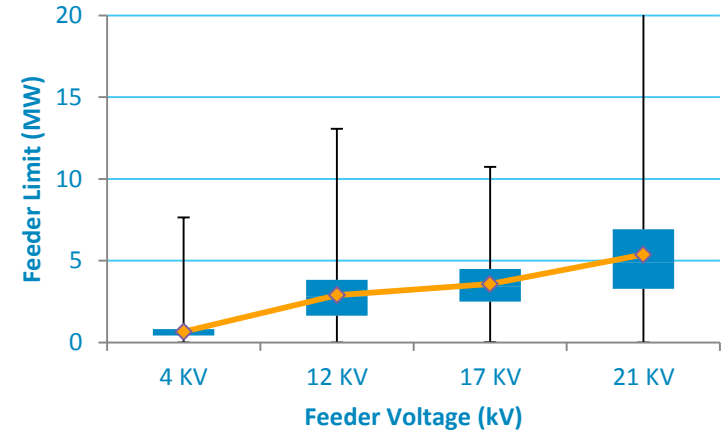
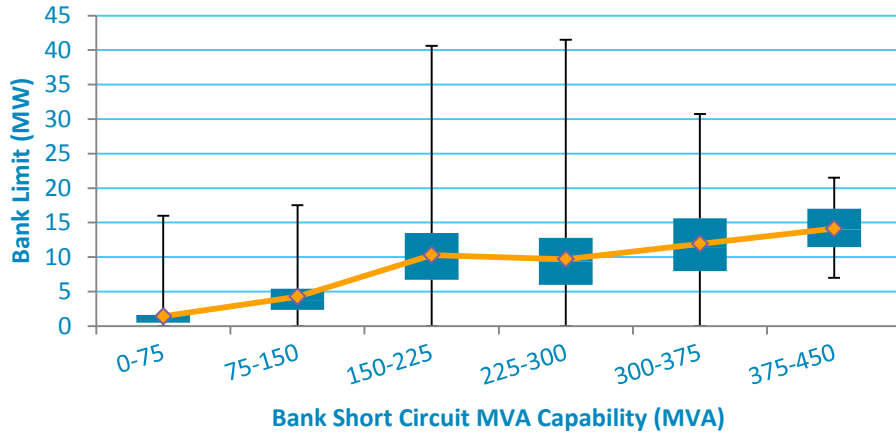

*NOTE: Results based on July 1 2015 ICA data*

# Results Analysis for Uniform Generation (Machine)

**Typical DER Use Case:** Hydro, Bio-Gas, and other DER with constant full output using machinery

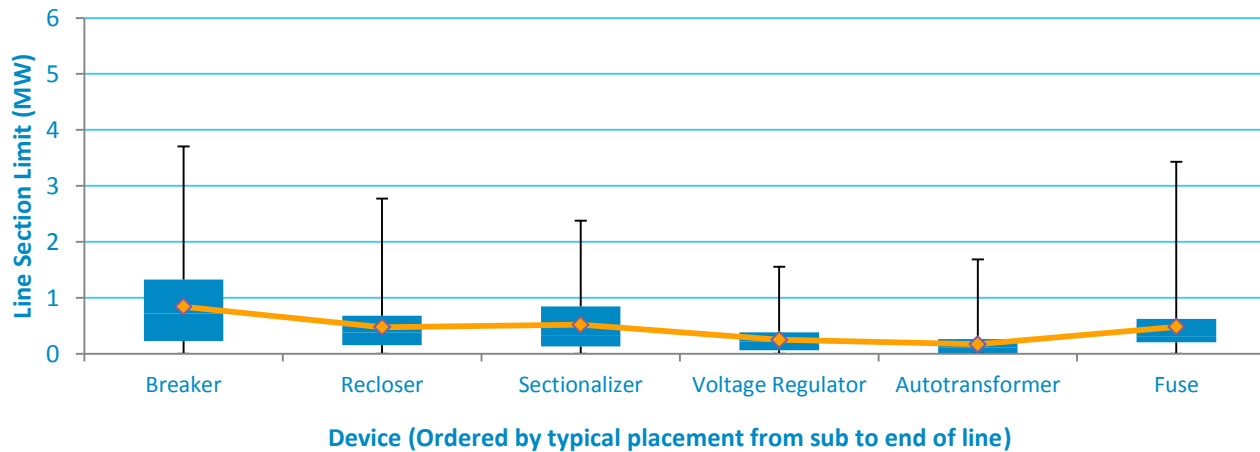
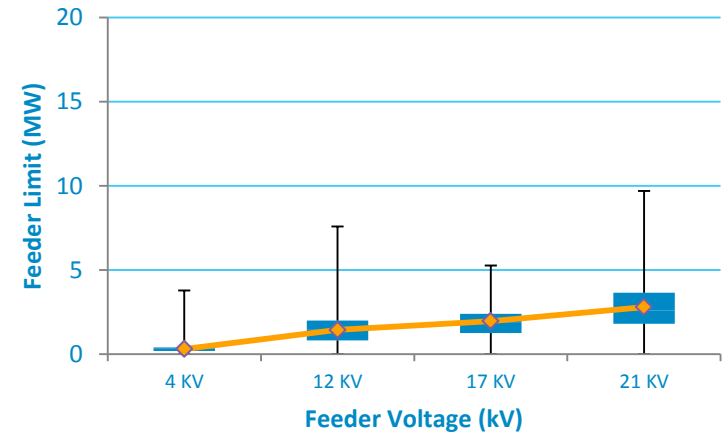
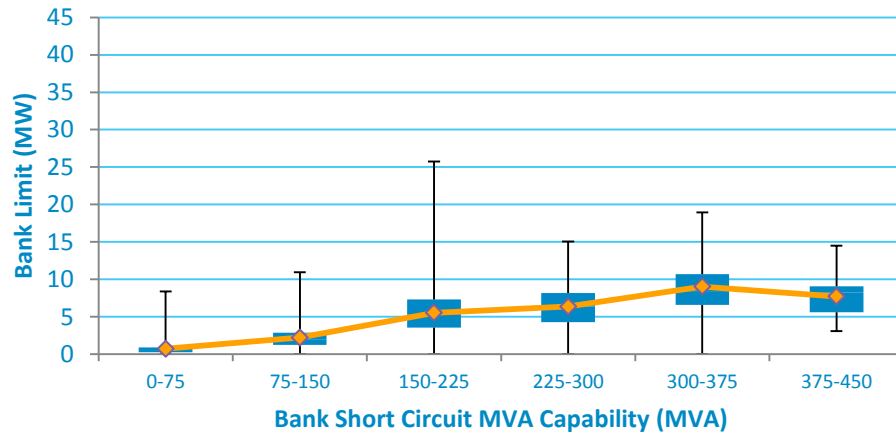

*NOTE: Results based on July 1 2015 ICA data*

# Results Analysis for Uniform Load

**Typical DER Use Case:** Storage Charging Capability without Time Constraints

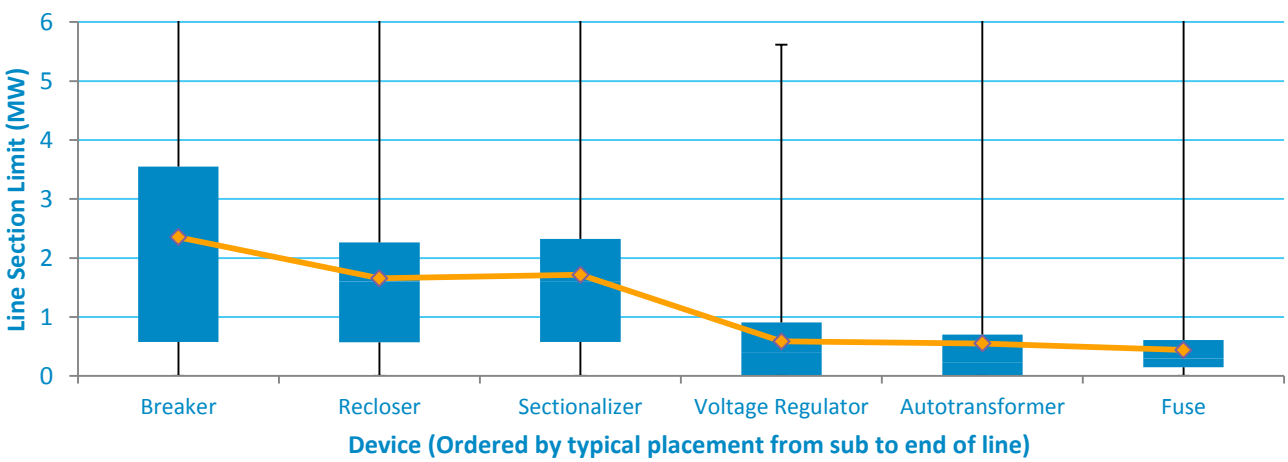
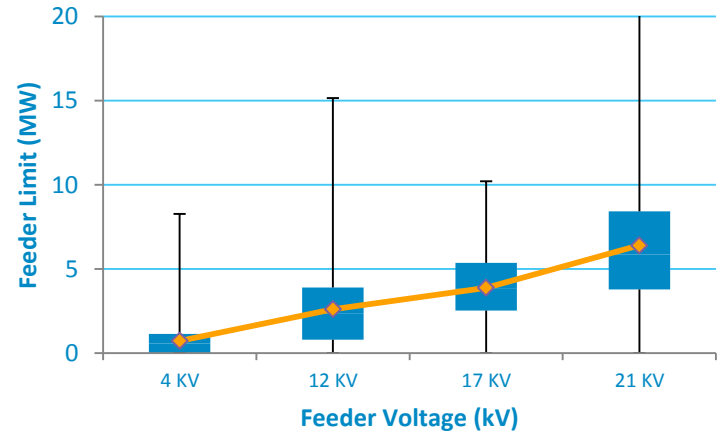
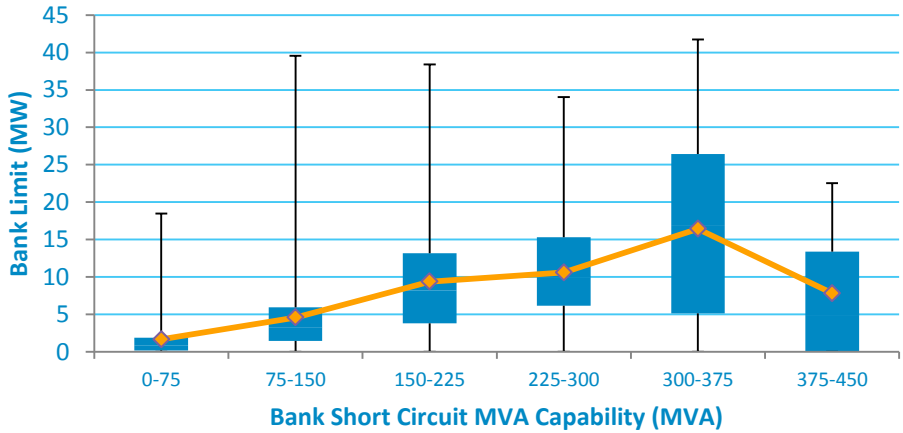

*NOTE: Results based on July 1 2015 ICA data*

# ICA Conclusions and Next Steps

- Higher capacities are found on higher voltage circuits and line sections closer to substation on average, but demand and locational conditions can cause variation in capacity
- Integration Capacity is dependent on DER hourly profiles and specific operating characteristics
- Integration Capacity Analysis at this stage can guide customers to better locations, but will not replace the interconnection process
- To fully inform an optimal location analysis the assessment requires inclusion of transmission level models and conditions



# Locational Benefits and Costs Methodology

# Locational Benefits and Costs Methodology

- Purpose of optimal location benefits/costs analysis is to:
  - Identify locations where DERs have potential benefits and lowest cost impacts to the grid
  - Enable PG&E to make better distribution investment decisions for our customers
- General approach
  - Use location-specific benefits or costs (avoided or increased utility costs) to select optimal locations for DERs
  - Major cost/benefit categories
    - **Distribution**
    - **Transmission**
    - **Generation**
    - **Other Societal, Safety**

# Guidance on Locational Value Components

Start with DERAC\*, add granularity and include new components

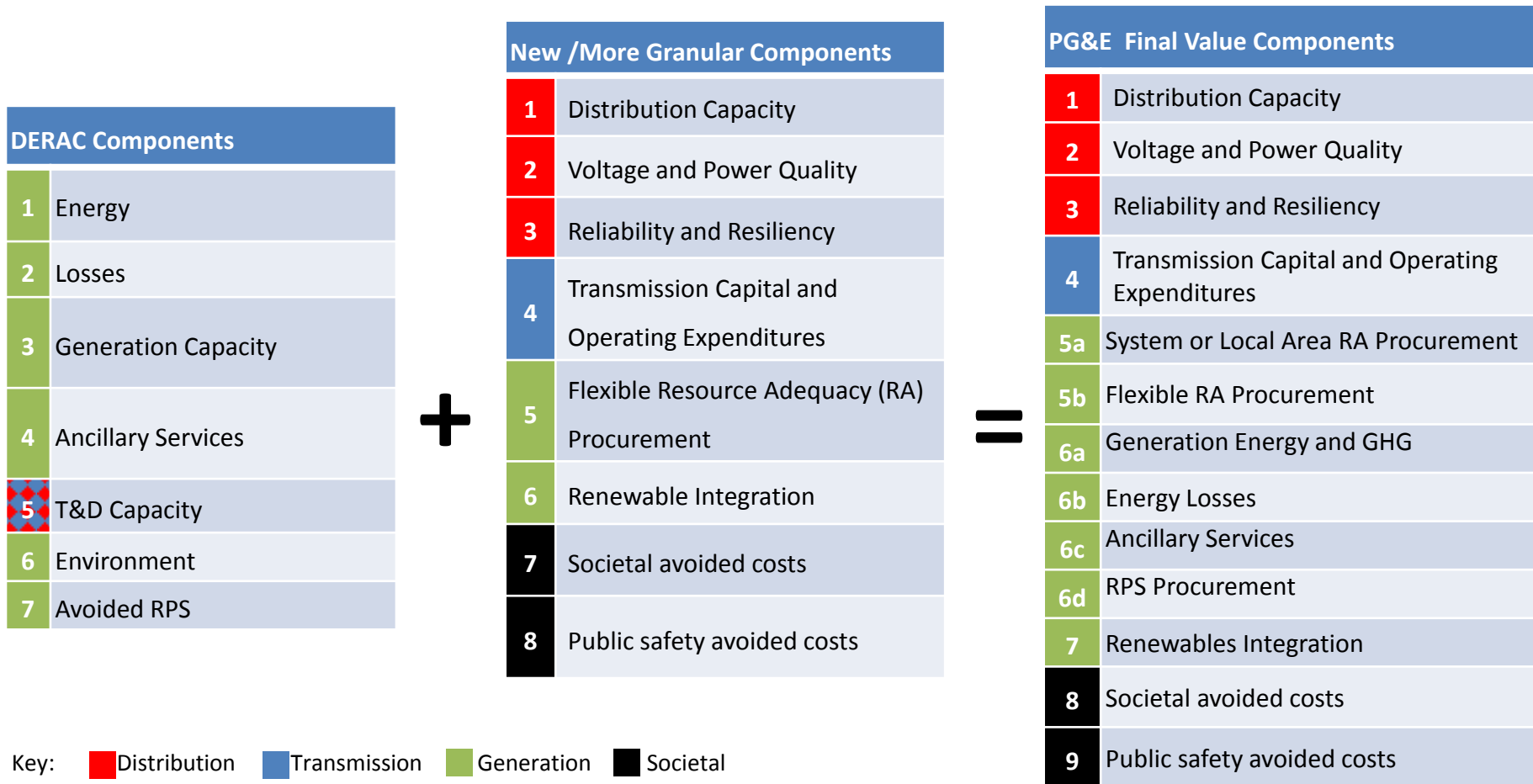

\* E3's Distributed Energy Resources Avoided Cost Calculator (DERAC) estimates avoided costs uniformly across the ISO system

# Structure of PG&E's Methodology

## Descriptions for each Component

### **Value Component Name**

### **Value Component Definition**

### **Determining DERs' Impact**

How to quantify DERs' impact (decrease / increase) on the utility's need for this value component

### **Translating DER Impact Into Avoided or Increased Cost**

How to translate an increased or decreased need for this value component into monetary terms

### **Granularity of Locational Variation**

How location-specific does PG&E expect this component to be

# Example: Distribution Components (1- 3)

**Value Component Definition:** Avoided or increased cost associated with:

- 1) Distribution Capacity (accommodates forecasted loads)
- 2) Voltage & Power Quality (ensures power is delivered within specifications)
- 3) Reliability & Resiliency (ability to prevent / respond to routine / major outages)

**Determining DERs' Impact:** Distribution engineering tools are used to determine DERs' ability to meet criteria for

- Right Time (Coincides with a deficiency that requires investments)
- Right Availability (Performs in hours that coincide with deficiency)
- Right Location (Can be connected at a location that mitigates deficiency)
- Right Size (Can assure magnitude of impact is sufficient to mitigate deficiency)

**Translating DER Impact Into Avoided or Increased Cost:**

Present value of investment deferral (or acceleration) due to DER

**Granularity of Locational Variation:**

Anticipated to vary from feeder to feeder within PG&E service territory

# Example: Distribution Capacity (1)

**Value Component Definition:** Avoided or increased cost associated with:

- 1) Distribution Capacity (accommodates forecasted loads)
- 2) Voltage & Power Quality (ensures power is delivered within specifications)
- 3) Reliability & Resiliency (ability to prevent / respond to routine / major outages)

**Determining DERs' Impact:** Distribution engineering tools are used to determine DERs' ability to meet criteria for

- Right Time (Coincides with a deficiency that requires investments)
- Right Availability (Performs in hours that coincide with deficiency)
- Right Location (Can be connected at a location that mitigates deficiency)
- Right Size (Can assure magnitude of impact is sufficient to mitigate deficiency)

**Translating DER Impact Into Avoided or Increased Cost:**

Present value of investment deferral (or acceleration) due to DER

**Granularity of Locational Variation:**

Anticipated to vary from feeder to feeder within PG&E service territory

# Example: Distribution Capacity (1)

**Determining DERs' Impact:** Distribution engineering tools are used to determine DERs' ability to meet criteria for

- Right Time (Coincides with a deficiency that requires investments)
- Right Availability (Performs in hours that coincide with deficiency)
- Right Location (Can be connected at a location that mitigates deficiency)
- Right Size (Can assure magnitude of impact is sufficient to mitigate deficiency)

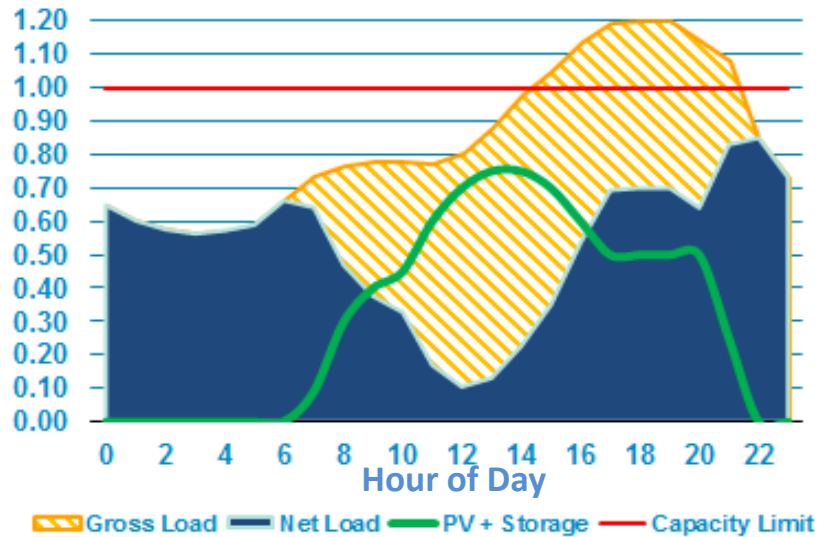
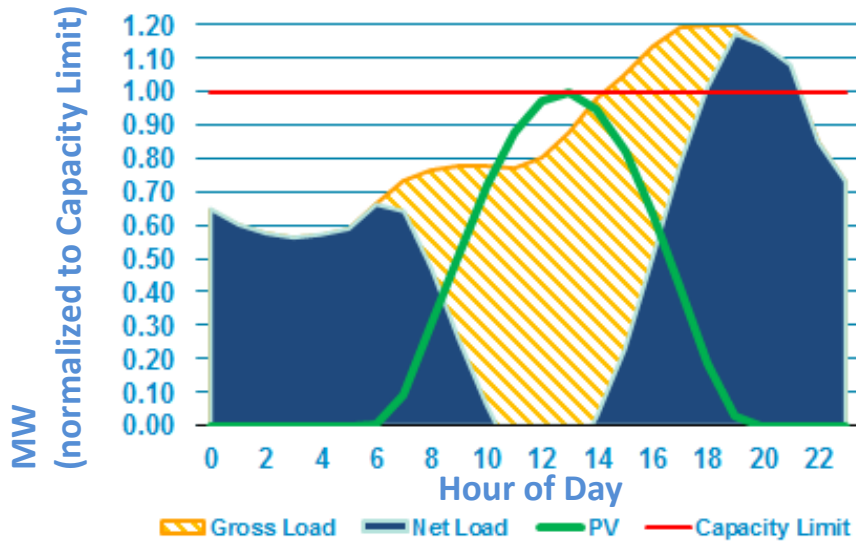

# IOUs' Value Components Are Aligned

- As requested in CPUC Guidance Ruling, the IOUs use a consistent approach to cover the same costs and values:
  - Start with the same E3 avoided cost components in DERAC
  - Add CPUC-prescribed components to produce a larger, more granular set of value components
  - Propose a methodology for calculating location-specific value for each component
- Slight variations in naming and grouping of value components and use of certain tools
- All IOUs note that methodologies need to be coordinated across a variety of DER-related proceedings and system planning processes
- DRPs suggest the IOUs' locational net benefits methodologies will be used to determine the best solutions for customer needs



# DER Growth Scenarios



## DER Growth Scenarios - Goal

- Better understand the magnitude and location of potential DER adoption to inform distribution system planning



# DERs included in Growth Scenarios

- Energy Efficiency
- Demand Response
- Retail\* Distributed Generation
  - Solar PV
  - Combustion and Heat to Power Technologies
  - Fuel Cells
- Retail\* Storage
- Electric Vehicles
- Combined Heat and Power Associated with the CHP Feed in Tariff Program
- Wholesale Distributed Generation\*\* (solar PV, bioenergy and small hydro)
- Wholesale Energy Storage\*\*



\*Retail = Behind-the-meter (BTM), or customer side of the meter

\*\*Utility side of the meter < 20 MWs

# PG&E Interpretation of DRP Guidance on DER Growth Scenarios

- **Scenario 1 - “Trajectory”**

PG&E’s best current estimate of expected DER adoption

- Adapted the CEC’s CED/IEPR DER forecasts
- PG&E 2015 IEPR submittals used instead of CEC forecast for PV
- Wholesale DG growth scenarios included in DRP, but not IEPR
- Storage forecasts not in IEPR but in DRP

- **Scenario 2 – “High Growth”**

Reflects ambitious levels of DER deployment that are possible with increased policy interventions and/or technology/market innovations

- **Scenario 3 – “Very High Growth”**

Likely to materialize only with significant policy interventions such as those outlined in the DRP Guidance Ruling

# Approach to Developing DER Growth Scenarios

## System-Level Forecasts Based On:

- Market analyst reports
- CPUC potential studies (EE)
- Existing procurement requirements
- Internal PG&E analysis

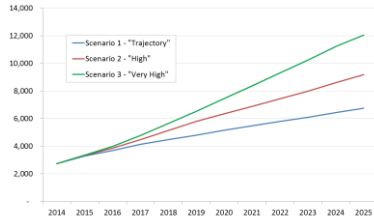

## Geographic Dispersion/Allocation to Circuit Varied by DER:

- DG deployment allocated based on key adoption drivers identified through multivariate regression analysis
- Location-specific DR load reductions developed using established econometric models and experimental design techniques
- For other technologies, DERs proportionally allocated proportionate to the customer segments and geographical areas that have seen
- Wholesale energy storage deployment allocated based on siting assumptions attributed to three generic project configurations

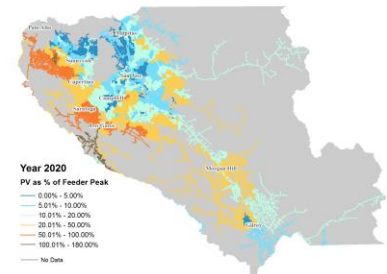

# Key Findings

1. DER growth may result in a significant net reduction in peak load
2. EE & Retail PV account for majority of DER capacity growth
3. DER deployment is likely to be clustered
4. Understanding customer load and adoption patterns is important for estimating potential DER growth
5. Distribution system impacts from DER growth depend on:
  - Local load patterns
  - DER technology generation/operation profiles
  - DER communications, controls, dispatchability and services provided

# Finding 1: DER growth may result in a significant net reduction in peak load

Estimated DER impacts at current time of PG&E system peak

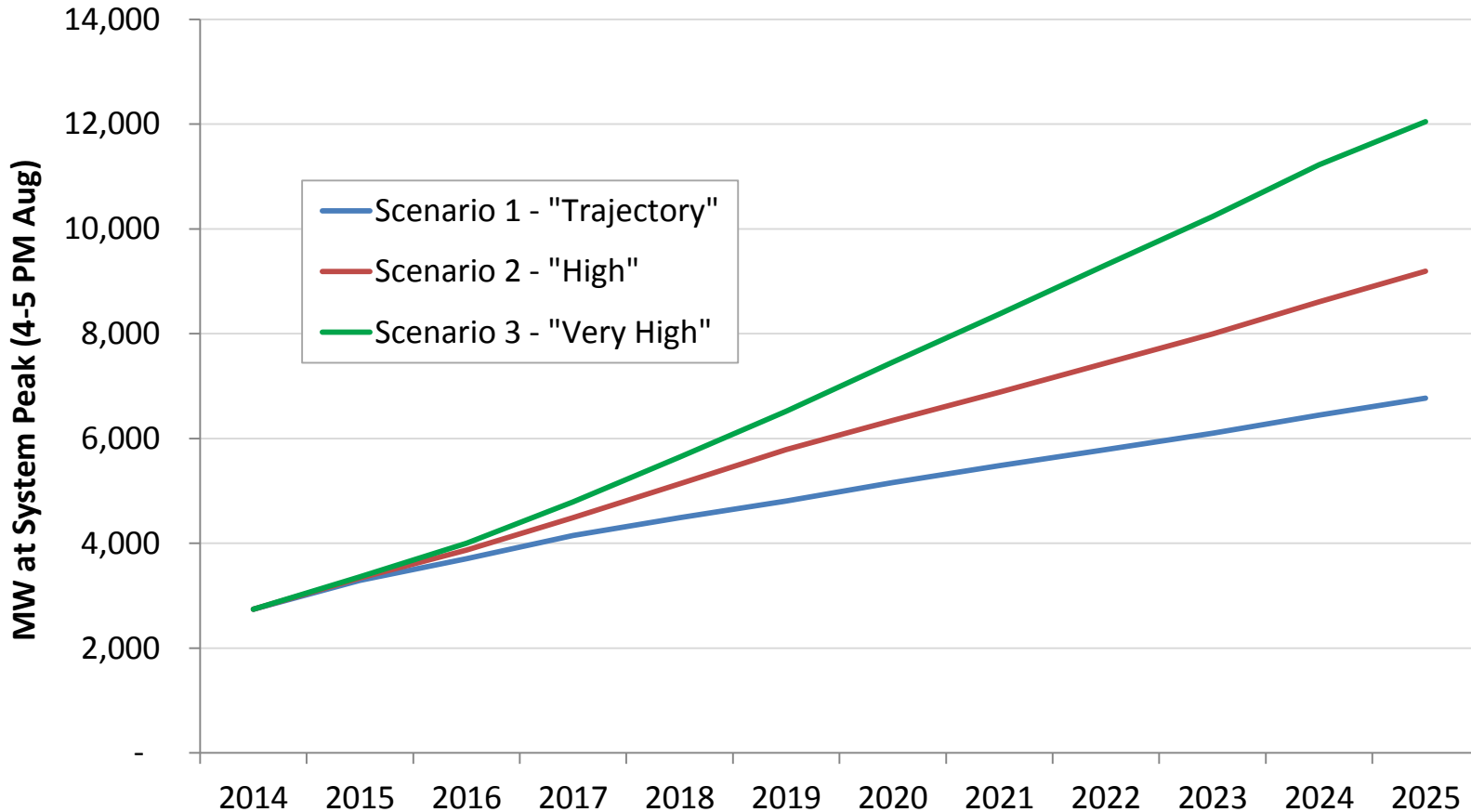

## Finding 2: Estimated impact at peak greatest for energy efficiency and retail solar

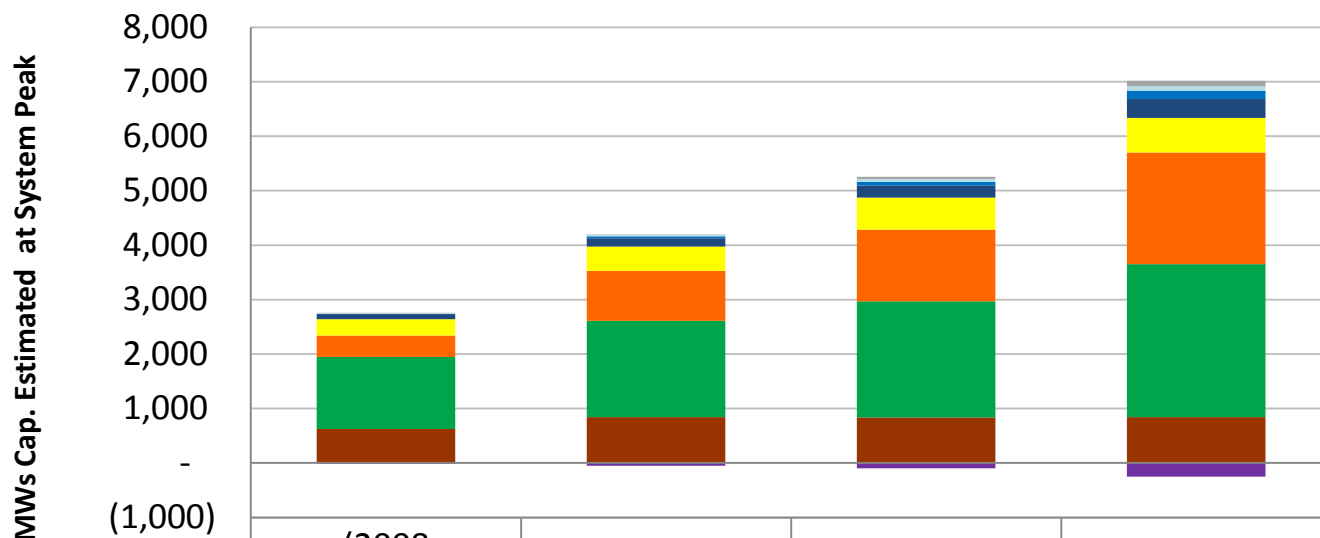

	(2008 -2014)	2017	2020	2025
■ Distributed Wholesale Energy Storage	6	6	40	97
■ CHP from Feed in Tariffs	9.6	30	50	83
■ Retail Storage	7.4	34	68	156
■ Retail Non-PV DG	92	153	220	347
■ Wholesale DG	302	443	590	631
■ Retail PV	396	916	1,317	2,052
■ Energy Efficiency	1,318	1,770	2,134	2,809
■ Demand Response	627	845	834	841
■ Electric Vehicles	(16)	(48)	(95)	(248)



# Finding 3: County-Level Distribution of All DERs Reveals “Hot Spots”

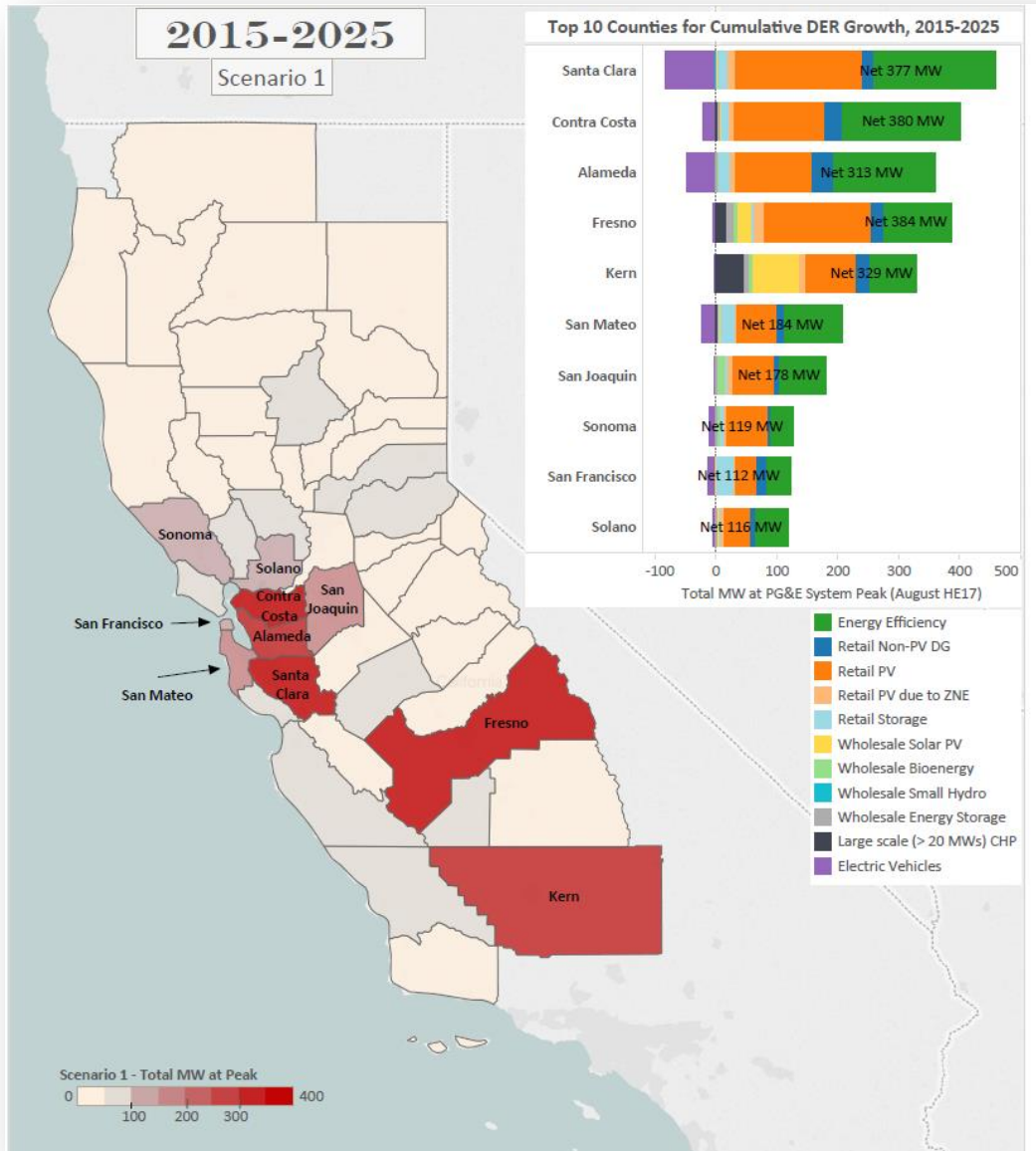

# Finding 3: DER Deployment is Likely to be Clustered

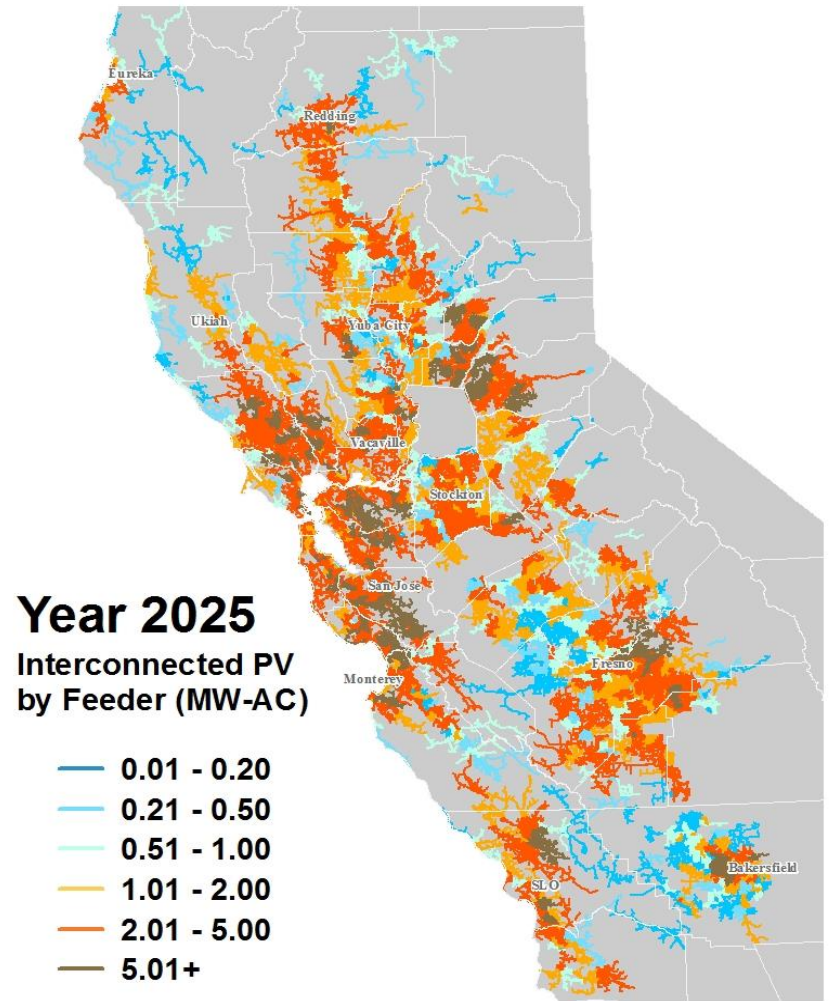
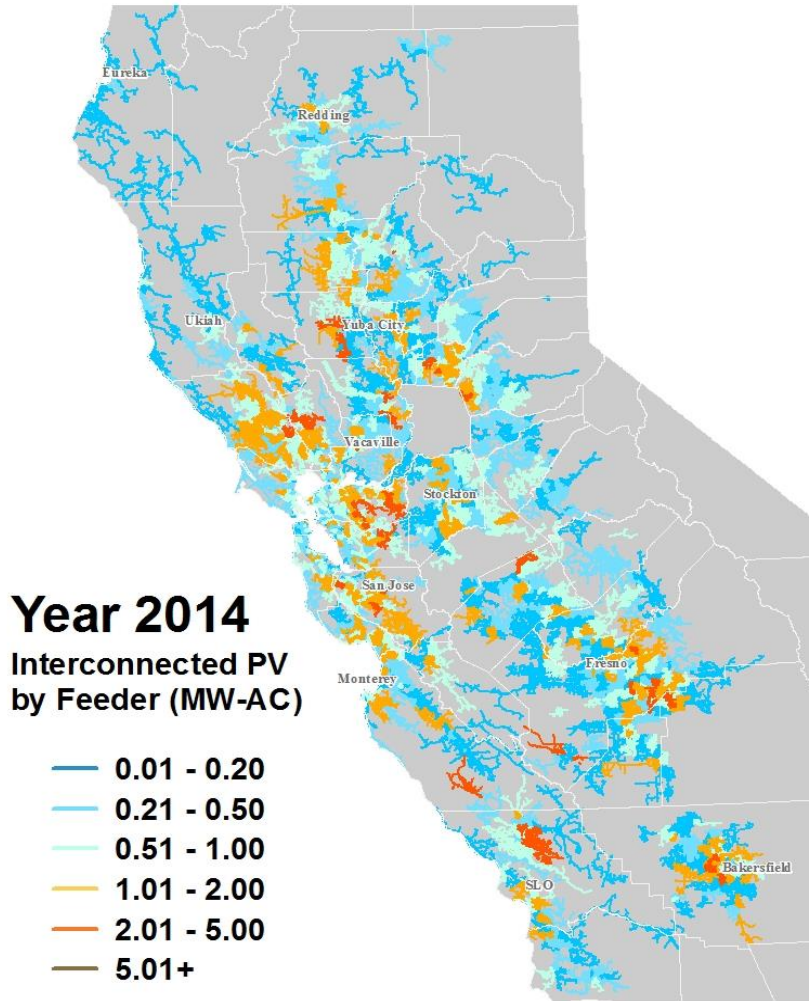

# Finding 4: Understanding customer load and adoption patterns important for estimating potential DER growth

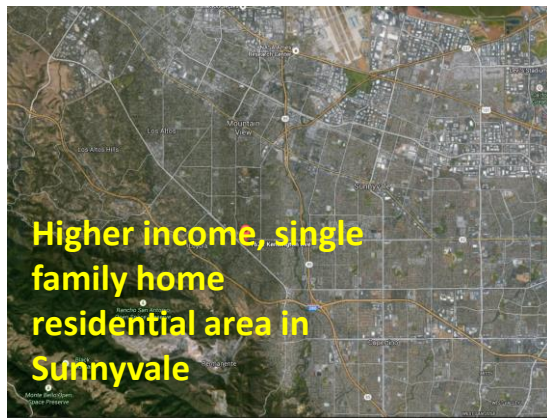
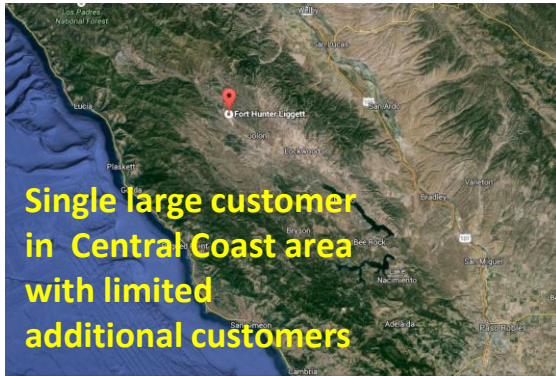

		<i>PV as % of Feeder Load</i>			
<b>Feeder (Circuit)</b>	<b>PV kW installed 2014</b>	<b>2014</b>	<b>2016</b>	<b>2020</b>	<b>2024</b>
CENTRAL COAST	2,283	35%	35%	35%	35%
SUNNYVALE	2,008	30%	94%	123%	125%

## Finding 5: Distribution System Impacts from DER Growth Depends on DER Characteristics and Local Load Patterns

- Variable impact driven by:
  - Coincidence of DER impact with local distribution asset load profile (e.g., evening peaking feeders with high solar deployment)
  - Resource characteristics (e.g., generation profile, associated communications and controls, dispatchability, geographic location, intermittency)
  - Services provided
- Utility currently has limited visibility, operational control and ability to influence geographic location of DER assets
- Deployment is currently optimized on customer economics, not utility cost drivers

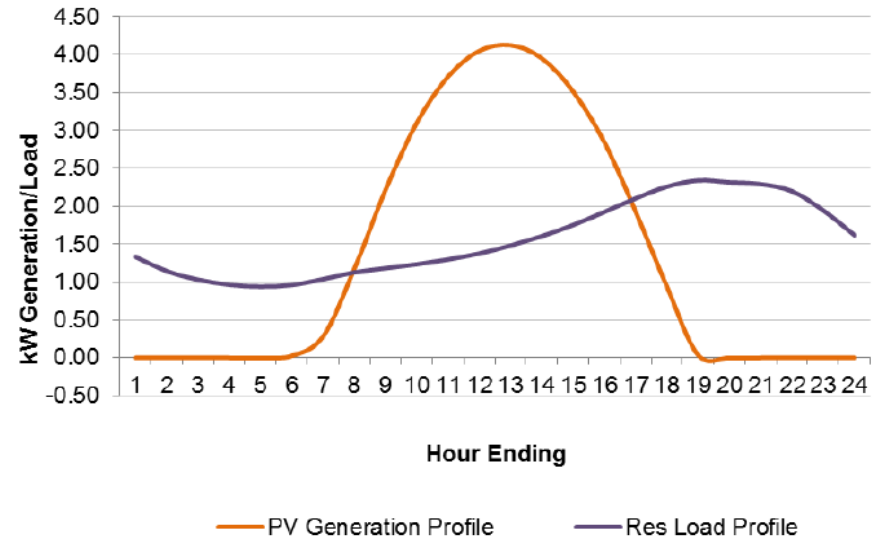
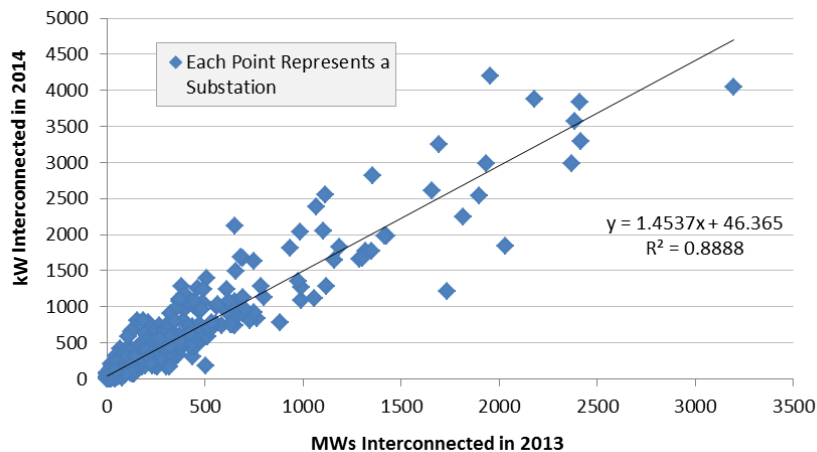

FIGURE 2-28: TYPICAL RESIDENTIAL LOAD PROFILE AND SOLAR GENERATION PROFILE ON AN AUGUST DAY

# Key Uncertainties and Limitations

- Historical DER consumer behavior may not be indicative of future patterns
- DER adoption is heavily determined by uncertain future policy developments
- Limited sample size for some technologies constrains PG&E’s ability to elicit general trends that can be applied across our service area
- Larger-scale on residential DER is installed in “chunks” rather than in more predictable incremental additions that might be seen on a distribution asset that serves primarily residential load

**PV interconnected by residential customers to a given substation, scatterplot of 2013 vs. 2014 annual additions.**



**PV interconnected by non-residential customers to a given substation, scatterplot of 2013 vs. 2014 annual additions.**

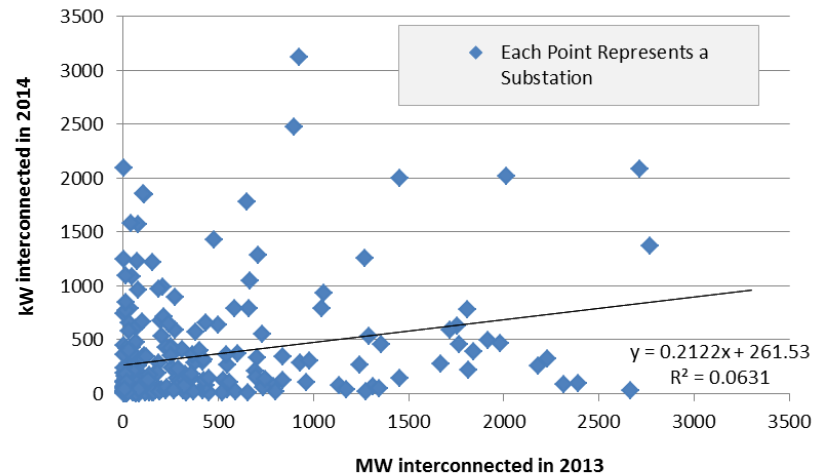

# Question and Answer Session

## Distribution Planning Methodologies

- Integration Capacity
- Optimal Location Benefit Analysis
- DER Growth Scenarios

# Demonstration and Deployment



# Demonstration and Deployment (Pilots)

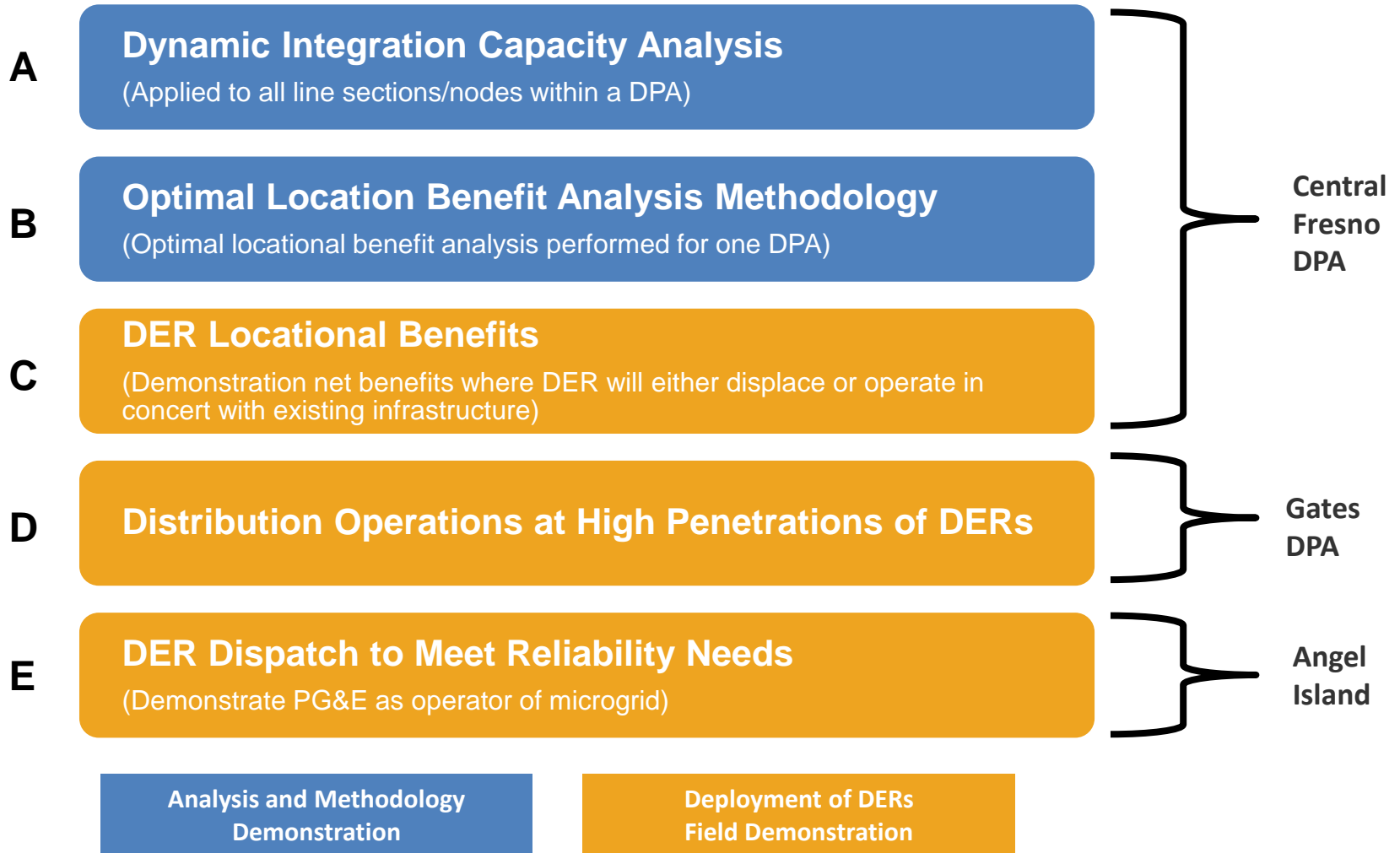



# Locations of PG&E's Demonstration Pilots

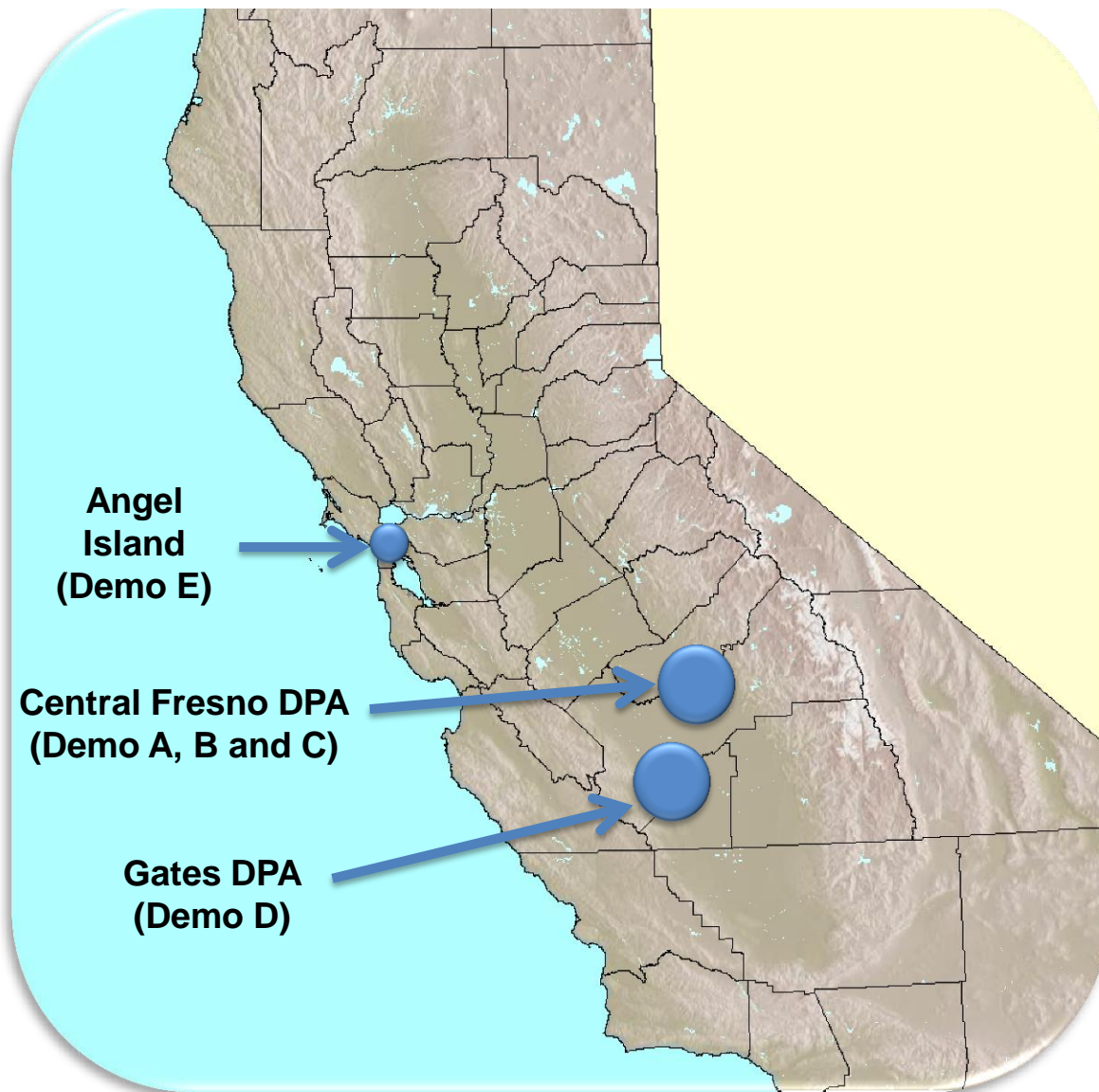

# Demonstration Pilots A, B and C

**Proposed Area of Demonstration:** Central Fresno DPA

## Scope of Pilots:

- a) Dynamic Integrated Capacity Analysis
- b) Optimal Location Benefit Analysis
- c) Near term (0-3 years) and longer term (3 or more years) distribution infrastructure project deferral:
  - **Phase 1 (Near Term)** – Build off of on-going Targeted Demand Side Management (TDSM) pilot (SMART AC technology on targeted distribution feeders from Barton Substation) in Central Fresno DPA that deferred substation transformer replacement
  - **Phase 2 (Longer Term)** – Develop targeted aggregated DER portfolio (EE, DR, DG, storage) for deferring longer term capacity needs for Central Fresno DPA.

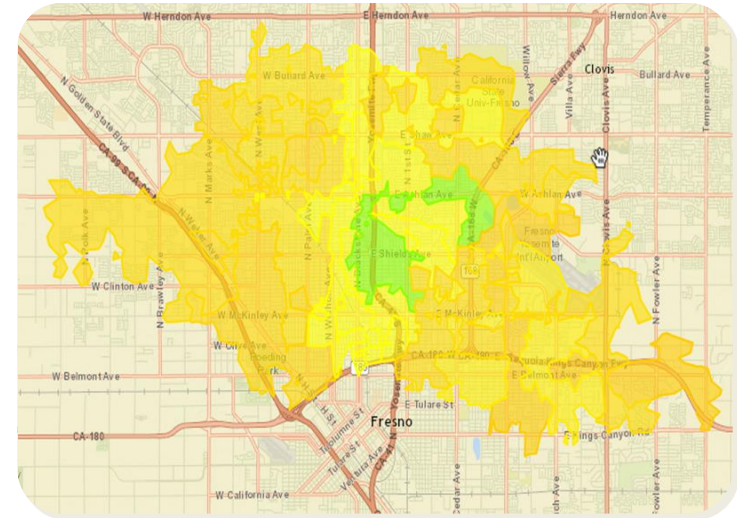

## Schedules:

**Pilot A:** Within 6 months of Commission approval of DRP

**Pilot B:** Within 12 months of Commission approval of DRP

**Pilot C:** Phase 1 – Implemented

Phase 2 – Detailed scope within 12 months of Commission approval.

# Demonstration Pilot D

## Proposed Area of Demonstration: Gates DPA

### Scope of Pilot:

- Integrate high DER penetrations that integrate into PG&E's distribution system operations, planning and investment for implementation.
  - Huron Substation projected to experience higher demand loading conditions in evening hours, lightly loading conditions during “daytime hours” due to peak solar production and seasonal loads.
  - Explore DER technologies (EE, DR, DG, EV and storage) coupled with existing rates to manage electric loading and reliability.

### Schedule

- Detailed scope within 12 months of Commission approval.

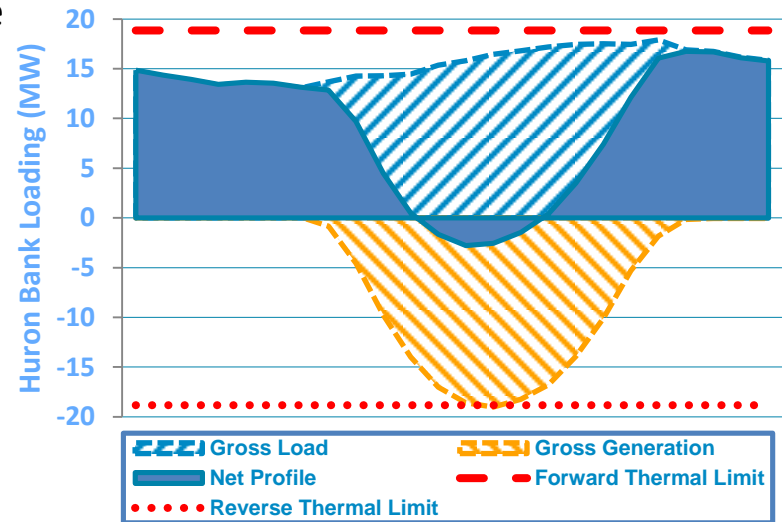
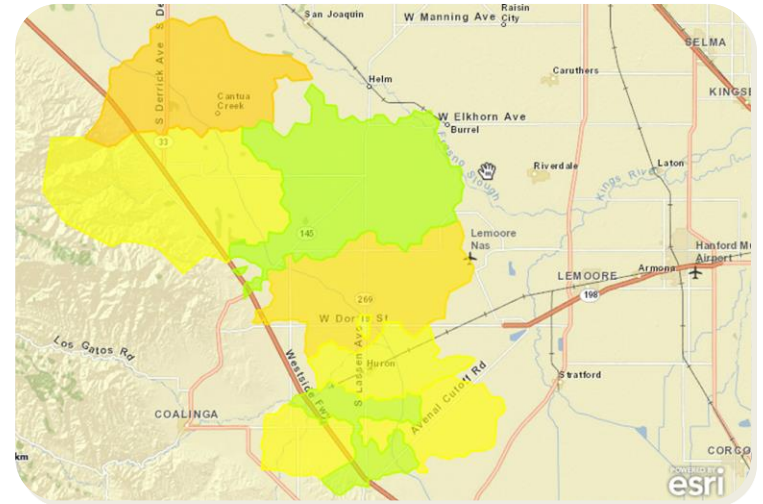

# Demonstration Pilot E

## Proposed Area of Demonstration: Angel Island

### Scope of Pilot:

- Demonstrate capability of managing and operating multiple DERs within a microgrid system.
  - Operate a microgrid comprised of an optimal DER portfolio that will run 24 × 7 and 365 days to serve Angel Island demand.
  - Explore DERMS and DER technologies (EE, DR, DG, EV and storage).

### Schedule

- Detailed scope within 12 months of Commission approval.

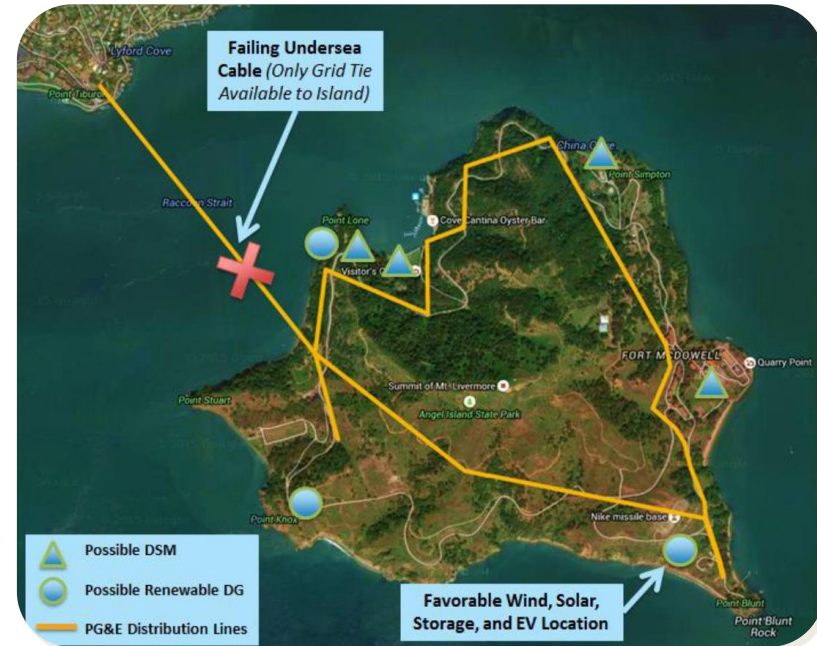

# Data Access and Sharing

- Subject to cost recovery, PG&E to provide web-based platforms, tools and portals for convenient and continuous access to:
  - Updated distribution planning data
  - Standards
  - Project specific applications
- Web-based tools and portals modeled on similar web-based tools made available to customers, developers and public in PG&E's interconnection, Customer Data Access and Energy Data Center proceedings.
- Customer-specific data will be accessible if individual customer provides express prior written consent to disclose data
- Consistent with customer privacy, physical security and cyber-security rules and protections

# Tariffs and Contracts

- **PG&E does not intend, in the near term, to recommend in the DRP to make significant changes to its tariffs**
  - Leverage and coordinate ongoing work from other proceedings
- **Demonstration and Deployment**
  - Developing innovative commercial solicitations and contractual structures to support deployment of distribution connected DERs.
  - Service based contracts targeting specific locations on distribution grid (e.g. Capacity, Voltage Management, Power Quality, etc..)

# Safety Considerations

- **Current Reliability and Safety Requirements**
  - DERs follow same interconnection requirements for load and/or generation interconnection requirements
- **Potential Modifications**
  - Consideration how increased volume of DERs along with variable output could impact life of Utilities distribution equipment
  - Consideration of coordinated interconnection process for multiple DER technologies behind single interconnection point (PV, Storage and EV)
  - Cybersecurity related to real-time data exchange between DERs and Utility
- **Efforts to Engage Local Authorities relevant to local permitting**
  - Increased education to local authorities about DER technologies and processes
  - Additional coordination in interconnection process

# Question and Answer Session

- Demonstration and Deployment
- Data Access
- Tariffs and Contracts
- Safety Considerations



# Barriers to Deployment

## Integration and Interconnection

Predicting future DER adoption

Integration of DERs into Transmission Planning and Operation

Local permitting of DERs

## Limit ability of DERs to provide benefits

DER equipment operational limitations

Resource availability and intermittency

## Distribution System Operational and Infrastructure Capabilities

Advance Protection, Control and Monitoring not deployed to manage DERs

# Coordination with GRC

- **DRP Related Investments/Actions to be Included in 2017 GRC**
  - Distribution Upgrades to Increase Integration Capacity
  - Distribution Deferrals due to Anticipated DER Growth
  - DER Alternative Planning Standard

# Coordination with CEC and Utility Load Forecasting

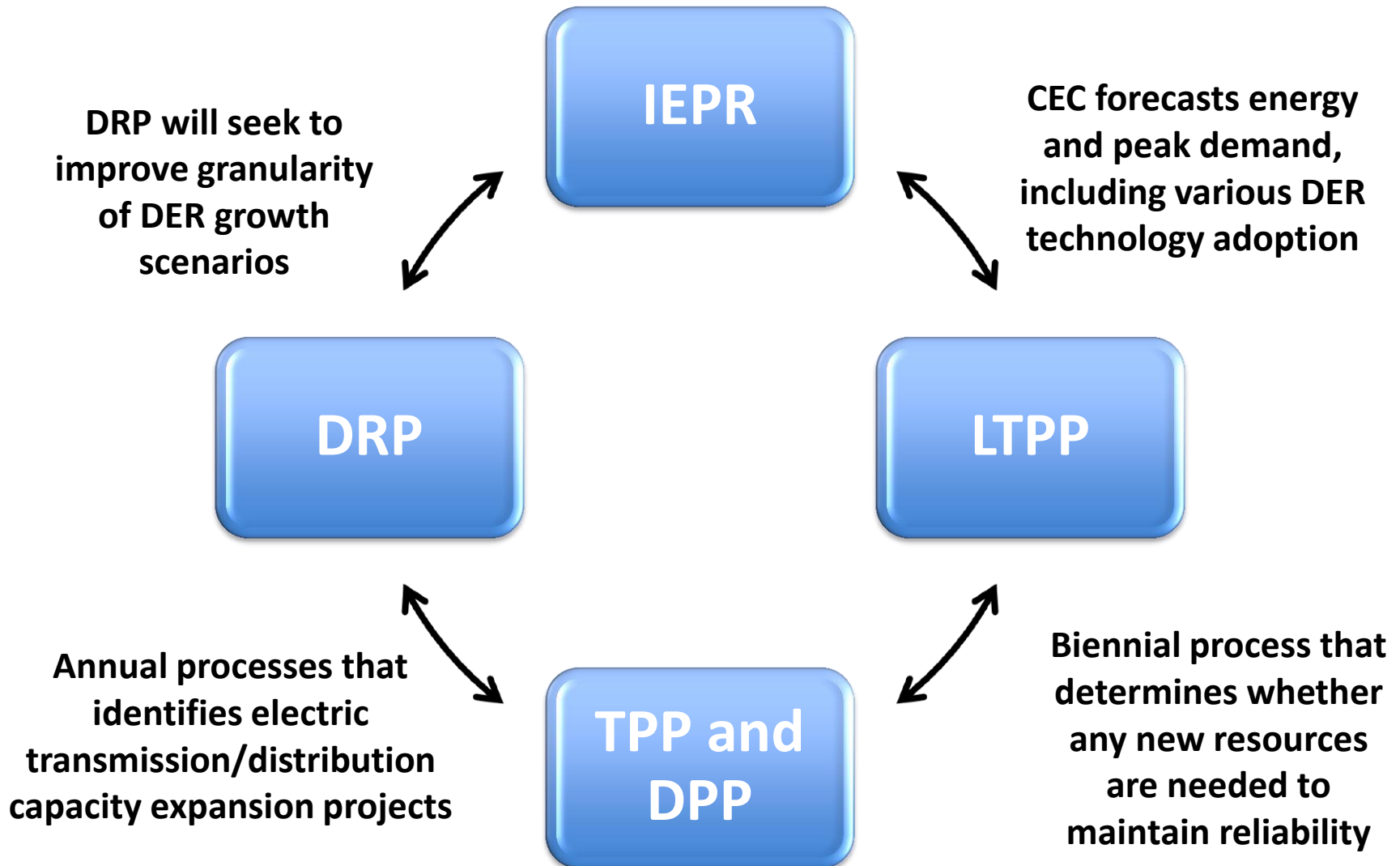

# Phasing of Next Steps

- **Rolling Updates to PG&E's DRP**

- Incorporate DRP improvements into PG&E's annual distribution planning process (DPP)
- Issue annual DRP update report on progress of DER integration into planning, operations and investment.

- **Phased Approach to DRP Filings**

- Phase 1 (2016-17): Refine DER integration methodologies and tools. Assess transmission impacts. Deploy DRP pilots.
- Phase 2a (2018-19): Assess learnings from deployed DRP pilots, planning and design of communications infrastructure to support monitoring and control of DERs. Develop Distributed Energy Resource Zones that could be attributed to locational values.
- Phase 2b (2019 and beyond): Enhancement of DER distribution deferral mechanisms. Consideration of proposals for DER services that are ancillary to distribution capacity needs.

# Question and Answer Session

- Barriers to Deployment
- DRP Coordination with Utility and CEC Load Forecasting
- DRP Coordination with Utility General Rate Case
- Phasing of Next Steps

# Schedule

- Protests and responses due on **August 31, 2015**
- Replies to protests and responses due on **September 15, 2015**
- Prehearing Conference on **September 23, 2015**