

The background of the cover is a composite image. The top portion shows a white wind turbine against a blue sky with scattered white clouds. Below this, there is a semi-transparent grey overlay containing a line graph with green bars and a calculator. The bottom portion of the cover shows a 3D rendering of an industrial facility with various pieces of machinery and equipment.

SGIP

2015 Self-Generation Incentive Program Cost Effectiveness Study

[Final Report]

Submitted to:
PG&E and
The SGIP
Working Group

Prepared by:



330 Madson Pl
Davis, CA 95618

October 5, 2015

TABLE OF CONTENTS

- TABLE OF CONTENTS..... i**
- LIST OF FIGURES..... vi**
- LIST OF TABLES xii**
- GLOSSARY xiv**
- 1 Executive Summary..... 1-1**
 - 1.1 Cost Tests for SGIP Technology Evaluation1-2
 - 1.2 Key Findings1-4
 - Societal Test Results1-4
 - Participant Cost Test Results1-7
 - Combined STRC and PCT Results1-9
 - Results on Modified Internal Rate of Return.....1-11
 - 1.3 Recommendations.....1-12
- 2 Introduction and Objectives..... 2-1**
 - 2.1 California’s Self-Generation Incentive Program2-1
 - 2.2 Cost Effectiveness Analyses of sGIP Technologies2-2
 - Objectives of this Study2-3
 - Changes from the 2011 Cost Effectiveness Study2-3
 - 2.3 Scope2-5
 - Cost Test Perspectives2-5
 - Twenty-year Timeframe (2014–2034).....2-6
 - 2.4 Report Organization2-6
- 3 Background and Status 3-1**
 - 3.1 SGIP-Supported DER in California.....3-1
 - Specific SGIP Technologies and Configurations Evaluated3-2
 - 3.2 The Changing Face of SGIP Technologies3-4
 - Technology Advancements3-4
 - Distributed Generation and Storage Policies3-5
 - A New Distributed Generation and Storage Market3-5
 - 3.3 SGIP’s Role IN DISTRIBUTED generation and storage Development3-6
- 4 Cost Effectiveness Approach and Methodology 4-1**
 - 4.1 Overview of SGIP Cost Effectiveness Approach.....4-1
 - 4.2 Evaluation Cost Tests4-3
 - Participant Cost Test4-3
 - Total Resource Cost Test4-3
 - Societal Total Resource Cost Test.....4-4
 - Program Administrator Cost Test4-5
 - 4.3 Use of Learning Curves in Estimating Future Technology Costs4-6
 - 4.4 Critical Inputs and Assumptions4-9
 - SGIP Technology Operations4-9



- Critical Costs 4-14
- Critical Benefits 4-20
- 5 The SGIP Cost Effectiveness Model: SGIPce..... 5-1**
 - 5.1 Model Objectives..... 5-1
 - 5.2 Model Approach 5-3
 - 5.3 Model Structure 5-7
 - Critical Inputs 5-7
 - SGIPce Run Processor..... 5-9
 - Viewing Calculation Engine and Results..... 5-9
- 6 SGIP Cost Effectiveness Results 6-1**
 - 6.1 Overall Summary of Results 6-2
 - 6.2 Societal Cost Test Results 6-10
 - Statewide Results 6-11
 - 6.3 Participant Cost Test Results 6-55
 - Statewide Results 6-55
 - 6.4 Program Administrator Cost Test Results..... 6-108
- Appendix A Investigated SGIP Technologies A-1**
 - A.1 Introduction A-1
 - Learning Curves and Progress Ratios A-1
 - Treatment of Biogas Collection and Clean-Up Costs..... A-5
 - A.2 Fuel Cells A-8
 - Technology Summary A-8
 - Technology Operating Characteristics..... A-9
 - Current Technology Capital Costs A-12
 - Current Technology Operating and Maintenance Costs A-13
 - Total 2013 Cost Estimates A-13
 - Estimating Future Capital Costs A-15
 - A.3 Small Gas Turbines A-17
 - Technology Summary A-17
 - Technology Operating Characteristics..... A-18
 - Current Technology Capital Costs A-21
 - Current Technology Operating and Maintenance Costs A-22
 - Estimating Future Capital Costs A-23
 - A.4 Internal Combustion Engines A-27
 - Technology Summary A-27
 - Technology Operating Characteristics..... A-28
 - Current Technology Capital Costs A-32
 - Current Technology Operating and Maintenance Costs A-32
 - Estimating Future Capital Costs A-34
 - A.5 Microturbines..... A-38
 - Technology Summary A-38



- Technology Operating Characteristics..... A-39
- Current Technology Capital Costs A-41
- Current Technology Operating and Maintenance Costs A-42
- Total 2013 Cost Estimates A-43
- Estimating Future Capital Costs A-44
- A.6 Organic Rankine Cycles A-46
 - Technology Summary A-46
 - Technology Operating Characteristics..... A-48
 - Current Technology Capital Costs A-49
 - Current Technology Operating and Maintenance Costs A-49
 - Total 2013 Cost Estimates A-50
 - Estimating Future Capital Costs A-50
- A.7 Wind A-51
 - Technology Summary A-52
 - Technology Operating Characteristics..... A-54
 - Current Technology Capital Costs A-57
 - Current Technology Operating and Maintenance Costs A-57
 - Total 2013 Cost Estimates A-58
 - Estimating Future Capital Costs A-60
- A.8 Storage A-65
 - Technology Summary A-66
 - Technology Operating Characteristics..... A-68
 - Current Technology Capital Costs A-74
 - Current Technology Operating and Maintenance Costs A-75
 - Total 2014 Cost Estimates A-75
 - Estimating Future Capital Costs A-76
- A.9 Pressure Reduction Turbine A-78
 - Technology Summary A-78
 - Technology Operating Characteristics..... A-79
 - Current Technology Capital Costs A-80
 - Current Technology Operating and Maintenance Costs A-80
 - Estimating Future Capital Costs A-81
- A.10 Technology Summary A-83
- APPENDIX B Investigated Utility-Scale Technologies B-1**
 - B.1 Introduction..... B-1
 - B.2 Aeroderivative Combustion Turbines (Simple Cycle) B-1
 - Technology Summary B-1
 - Current Technology Capital Costs B-2
 - Current Technology Operating and Maintenance Costs B-3
 - Levelized Cost of Energy..... B-4
 - B.3 Combined Cycle Gas Turbines B-4



- Technology Summary B-5
- Current Technology Capital Costs B-6
- Current Technology Operating and Maintenance Costs B-6
- Levelized Cost of Energy B-7
- Appendix C Detailed Modified Internal Rate of Return (MIRR) Charts C-1**
 - C.1 MIRR Chart Location C-1
 - Advanced Energy Storage C-2
 - Fuel Cells C-18
 - Pressure Reduction Turbines C-73
 - Organic Rankine Cycle C-80
 - Gas Turbines C-87
 - IC Engines C-124
 - Microturbines C-161
 - Wind C-180
- Appendix D SGIPce User Guide D-1**
 - D.1 Overview of the SGIPce Model D-1
 - Structure of the Model D-1
 - Run Processor D-2
 - Technology Inputs D-2
 - Global Inputs D-3
 - Avoided Cost Workbooks D-3
 - Electric and Gas Rate Workbooks D-4
 - Adoptions D-4
 - Calculation Engine D-5
 - D.2 Setting Up the Model (Quick Start Guide) D-5
 - Installing the Model D-5
 - Using the System D-6
 - D.3 Changing Inputs to Run Scenarios D-23
 - Changing Parameters in the Technology Definitions Table D-24
 - D.4 Making Manual Changes to Inputs D-28
 - Onsite Biogas D-28
 - Changes in Capital Costs D-29
 - Changing O&M Costs D-30
 - Changing the Directed Biogas Adder D-30
 - Finally D-31
- Appendix E Equations and Methods in Cost Effectiveness Tests E-1**
 - E.1 Overall Approach E-1
 - Nomenclature Used in Equations E-1
 - Participant Cost Test E-1
 - Participant Benefits E-8
 - Societal Total Resource Cost and Total Resource Cost Tests E-13



Societal Costs.....E-13
Societal BenefitsE-16
Program Administrator Cost Test.....E-19
Program Administrator CostsE-19
Program Administrator BenefitsE-21

LIST OF FIGURES

- Figure 1-1: Statewide Societal Total Resource Cost (STRC) Test Results without Incentives at 20201-6
- Figure 1-2: Statewide Participant Cost Test (PCT) Results without Incentives at 20141-8
- Figure 1-3: Combined Statewide 2020 STRC and 2014 PCT Results without Incentives1-10
- Figure 1-4: Comparison of MIRR for SGIP SYSTEMS without Incentives and with 2014 Incentives1-11
- Figure 1-5: Program Administrator cost results: 2014 and 2020 (weighted)1-13
- Figure 3-1: Cumulative Rebated Capacity by Calendar Year3-7
- Figure 4-1: PV Learning Curve4-8
- Figure 4-2: Simplified CHP Diagram Showing Heat and Electricity Flows4-11
- Figure 4-3: Example of Summarized Costs for a 500 kW Fuel Cell with CHP4-16
- Figure 4-4: Comparison of 2010 and 2014 Installed Costs of SGIP Technologies (2014\$)4-17
- Figure 4-5: Comparison of 2013 Self-reported Costs in SGIP Against 2014 Estimated Installed Costs (2014\$)4-18
- Figure 5-1: Screenshot of Opening Screen of SGIPce Model5-3
- Figure 5-2: Screen Shot of Levelized Lifetime Values Generated in Model5-4
- Figure 5-3: Graphical Presentation of Cost Test Results5-6
- Figure 5-4: Overall Structure of the SGIPce Model5-7
- Figure 5-5: Representative Electricity Generation and Waste Heat Recovery Profiles5-11
- Figure 6-1: Statewide STRC Test Results for SGIP Technologies at 2020 (No Incentive)6-4
- Figure 6-2: Statewide PCT Results for SGIP Technologies at 2014 (No Incentive)6-6
- Figure 6-3: Combined 2020 STRC and 2014 PCT Results (No Incentive)6-8
- Figure 6-4: Statewide STRC Results by Non-Fuel Technologies (2014 and 2020), No Incentives6-15
- Figure 6-5: STRC Levelized Cost and Benefit Components for Non-Fuel SGIP Technologies, PG&E Territory, No Incentive, 20146-17
- Figure 6-6: Representative STRC Test Results for Residential 5 kW Storage System6-18
- Figure 6-7: Representative STRC Test Results for Commercial 30 kW Storage System6-19
- Figure 6-8: Representative STRC Test Results for Commercial 5 Mw Storage System6-20
- Figure 6-9: Representative STRC Test Results for 50 kW Wind System6-21
- Figure 6-10: Representative STRC Test Results for 1.5 MW Wind System6-22
- Figure 6-11: Representative STRC Test Results for 400 kW Pressure Reduction Turbine System6-23
- Figure 6-12: Representative STRC Test Results for 500 kW Waste Heat to Power System6-24
- Figure 6-13: Statewide STRC Results by Natural Gas Fuel Technologies (2014 and 2020), No Incentives6-25
- Figure 6-14: STRC Levelized Cost and Benefit Components for Natural Gas SGIP Technologies, PG&E Territory, No Incentive, 20146-26
- Figure 6-15: Representative Societal Total Resource Cost Test for a Natural Gas 500 kW CHP Fuel Cell6-28



Figure 6-16: Representative Societal Total Resource Cost Test for a Natural Gas 500 kW Electric-Only Fuel Cell6-29

Figure 6-17: Representative Societal Total Resource Cost Test for a Natural Gas 1,200 kW Chp Fuel Cell6-30

Figure 6-18: Representative STRC Test Results for 2.5 MW Natural Gas Fueled Gas Turbine6-31

Figure 6-19: Representative STRC Test Results for 7 MW Natural Gas Fueled Gas Turbine6-32

Figure 6-20: Representative STRC Results for 500 kW Natural Gas Fueled IC Engine6-33

Figure 6-21: Representative STRC Results for 1.5 MW Natural Gas Fueled IC Engine6-34

Figure 6-22: Representative STRC Results for 200 kW Natural Gas Fueled Microturbine6-35

Figure 6-23: Statewide Societal TRC Results by Directed Biogas Fuel (2014 and 2020), No Incentives6-36

Figure 6-24: Representative Societal Total Resource Cost Test for a Directed Biogas 500 kW CHP Fuel Cell.....6-37

Figure 6-25: Representative Societal Total Resource Cost Test for a Directed Biogas 500 kW Electric-Only Fuel Cell6-38

Figure 6-26: Representative Societal Total Resource Cost Test for a Directed Biogas 1,200 kW CHP Fuel Cell.....6-39

Figure 6-27: Representative Societal Total Resource Cost Test for a Directed Biogas 2.5 MW Gas Turbine6-40

Figure 6-28: Representative Societal Total Resource Cost Test for a Directed Biogas 7 MW Gas Turbine6-41

Figure 6-29: Representative STRC for a Directed Biogas 500 KW IC Engine6-42

Figure 6-30: Representative STRC for a Directed Biogas 1500 KW IC Engine6-43

Figure 6-31: Representative Societal Total Resource Cost Test for a Directed Biogas 200 kW Microturbine.....6-44

Figure 6-32: Statewide Societal TRC Results by Onsite Gas Fuel (2014 and 2020), No Incentives6-45

Figure 6-33: STRC Levelized Cost and Benefit Components for Onsite Biogas Technologies, PG&E Territory, No Incentive, 20146-46

Figure 6-34: Representative Societal Total Resource Cost Test for an Onsite Biogas 500 kW CHP Fuel Cell6-48

Figure 6-35: Representative Societal Total Resource Cost Test for an Onsite Biogas 500 kW Electric-Only Fuel Cell6-49

Figure 6-36: Representative Societal Total Resource Cost Test for an Onsite Biogas 1,200 kW CHP Fuel Cell6-50

Figure 6-37: Representative STRC Results for 2.5 MW Onsite Biogas-Fueled Gas Turbine.....6-51

Figure 6-38: Representative STRC Results for 7 MW Onsite Biogas-Fueled Gas Turbine.....6-52

Figure 6-39: Representative STRC Results for 500 kW Onsite Biogas-Fueled IC Engine.....6-53

Figure 6-40: Representative STRC Results for 1500 kW Onsite Biogas-Fueled IC Engine.....6-54

Figure 6-41: Representative STRC Results for 200 kW Onsite Biogas-Fueled Microturbine6-55

Figure 6-42: Representative Participant Test Result for 5 kW RES Storage System6-59

Figure 6-43: Representative Participant Test Result for 30 kW Storage System6-60

Figure 6-44: SDG&E Participant Test Result for 30 kW Storage System.....6-61

Figure 6-45: PCT Results for 30 kW Storage (PG&E).....6-62

Figure 6-46: PCT Results for 30 kW Storage (SDG&E).....6-63

Figure 6-47: Representative Participant Cost Test Result for 5 MW Storage System6-64



Figure 6-48: SDG&E Participant Cost Test Result for 5 MW Storage System6-64

Figure 6-49: PCT Results for 5 MW Storage (PG&E)6-65

Figure 6-50: Representative Participant Test Result for 50 kW Wind System.....6-66

Figure 6-51: PCT Results for 50 kW Wind6-67

Figure 6-52: Representative Participant Test Result for 1500 kW Wind System.....6-68

Figure 6-53: PCT Results for 1500 kW Wind6-69

Figure 6-54: Representative PCT Result for 400 kW PRT System6-70

Figure 6-55: PCT Results for 400 kW PRT System (PG&E)6-71

Figure 6-56: Representative PCT Result for 500 kW ORC System (No SGIP Incentive)6-72

Figure 6-57: PCT Results for 500 kW ORC System6-73

Figure 6-58: Representative Participant Test Result For a Natural Gas 500 kW CHP Fuel Cell6-74

Figure 6-59: MIRR Analysis for 500 kW Natural Gas CHP Fuel Cell.....6-75

Figure 6-60: Representative Participant Test Result For a Natural Gas 500 kW Electric-Only Fuel Cell6-76

Figure 6-61: MIRR Analysis for 500 kW Natural Gas Electric-Only Fuel Cell6-77

Figure 6-62: Representative Participant Test Result for a Natural Gas 1,200 kW CHP Fuel Cell6-78

Figure 6-63: MIRRr Analysis for 1,200 kW Natural Gas CHP Fuel Cell6-79

Figure 6-64: Representative Participant Test Result for a Natural Gas 2.5 MW Gas Turbine6-80

Figure 6-65: MIRR Analysis for 2.5 MW Natural Gas-Fueled Gas Turbine.....6-81

Figure 6-66: Representative Participant Test Result for a Natural Gas 7 MW Gas Turbine6-82

Figure 6-67: Representative PCT Result for a 500 kW Natural Gas Fueled IC Engine.....6-83

Figure 6-68: MIRR Analysis for 500 kW Natural Gas-Fueled IC Engine.....6-84

Figure 6-69: Representative Participant Test Result for a 1500 kW Natural Gas Fueled IC Engine6-85

Figure 6-70: MIRR Analysis for 1500 kW Natural Gas-Fueled IC Engine6-86

Figure 6-71: Representative PCT Result for a 200 kW Natural Gas Fueled Microturbine6-87

Figure 6-72: MIRR Analysis for 200 kW Natural Gas-Fueled Microturbine6-88

Figure 6-73: Representative Participant Test Result for a Directed Biogas 500 kW CHP Fuel Cell.....6-89

Figure 6-74: Representative Participant Test Result for a Directed Biogas 500 kWw Electric-Only Fuel Cell6-90

Figure 6-75: MIRR Analysis for 500 kW Directed Biogas Electric-Only Fuel Cell.....6-91

Figure 6-76: Representative Participant Test Result for a Directed Biogas 1,200 kW CHP Fuel Cell.....6-92

Figure 6-77: Representative Participant Test Result for a Directed Biogas 2.5 MW Gas Turbine6-93

Figure 6-78: MIRR Analysis for 2.5 MW Directed Biogas-Fueled Gas Turbine.....6-94

Figure 6-79: Representative Participant Test Result for a Directed Biogas 7 MW Gas Turbine6-95

Figure 6-80: MIRR Analysis for 7 MW Directed Biogas-Fueled Gas Turbine.....6-96

Figure 6-81: Representative PCT Result for a Directed Biogas 500 kW IC Engine6-97

Figure 6-82: Representative Participant Test Result for a Directed Biogas 1500 kW IC Engine6-98



Figure 6-83: MIRR Analysis for 1500 kW Directed Biogas-Fueled IC Engine.....6-99

Figure 6-84: Representative PCT Result for a Directed Biogas 200 kW Microturbine.....6-100

Figure 6-85: MIRR Analysis for 200 kW Directed Biogas-Fueled Microturbine6-101

Figure 6-86: Representative Participant Test Result for an Onsite Biogas 500 kW IC Engine6-102

Figure 6-87: MIRR Analysis for 500 kW Onsite Biogas-Fueled IC Engine6-103

Figure 6-88: Representative PCT Result for an Onsite Biogas 1500 kW IC Engine6-104

Figure 6-89: MIRR Analysis for 1500 kW Onsite Biogas-Fueled IC Engine.....6-105

Figure 6-90: Representative Participant Test Result for an Onsite Biogas 200 kW Microturbine.....6-106

Figure 6-91: MIRR Analysis for 200 kW Onsite Biogas-Fueled Microturbine6-107

Figure 6-92: Comparison of MIRR for SGIP Technologies without Incentives and with 2014 Incentives.....6-108

Figure 6-93: Program Administrator Cost Results: 2014 and 2020 (Weighted)6-109

Figure A-1: Growth in Cumulative Capacity of 500 kW IC Engines A-3

Figure A-2: Drop in Installed Cost of 500 kW IC Engines with Increased Production A-4

Figure A-3: Generic Fuel Cell Schematic A-8

Figure A-4: Fuel Cell Degradation in the SGIP..... A-12

Figure A-5: Fuel Cell Growth Rate..... A-15

Figure A-6: Fuel Cell Learning Curve..... A-16

Figure A-7: Log-Log Fuel Cell Learning Curve..... A-16

Figure A-8: Projected Future Costs and Cumulative Global Capacity A-17

Figure A-9: Schematic of a Gas Turbine System A-18

Figure A-10: Gas Turbine Mean Hourly Capacity Factors for Inland Type Process..... A-20

Figure A-11: Gas Turbine Degradation in the SGIP A-21

Figure A-12: Degradation Factor versus Operation Hours A-21

Figure A-13: Gas Turbine Growth Rate..... A-24

Figure A-14: Gas Turbine Learning Curve (2.5 MW Systems) A-25

Figure A-15: Log-log Learning Curve for 2.5 MW Gas Turbines..... A-25

Figure A-16: Gas Turbine Learning Curve for 7 MW Systems..... A-26

Figure A-17: Log-log Learning Curve for 7 MW Gas Turbines..... A-26

Figure A-18: Projected Future Costs and Cumulative Global Capacity..... A-27

Figure A-19: Combined Heat and Power System Output A-29

Figure A-20: Mean Hourly Capacity Factors for IC Engines Used in Inland Type Occupancy Applications A-31

Figure A-21: IC Engine Degradation in the SGIP A-32

Figure A-22: IC Engine Growth Rate A-34

Figure A-23: IC Engine Learning Curve (500 kW) A-35

Figure A-24: Log-log IC Engine 500 kW Learning Curve A-36



Figure A-25: IC Engine Learning Curve (1,500 kW) A-36

Figure A-26: Log-log IC Engine 1500 kW Learning Curve A-37

Figure A-27: Projected Future Costs and Cumulative Capacity (1,500 kW)..... A-37

Figure A-28: Projected Future Costs and Cumulative Capacity (<500 kW)..... A-38

Figure A-29: Simple Schematic of Microturbine-based CHP System A-39

Figure A-30: C65 Net Power & Efficiency vs. Ambient Temperature at Sea Level A-40

Figure A-31: Microturbine Growth Rate A-44

Figure A-32: Microturbine Learning Curve A-45

Figure A-33: Log-log MT 200 kW Learning Curve A-45

Figure A-34: Projected Future Costs and Cumulative Global Capacity A-46

Figure A-35: Simplified Rankine Cycle A-47

Figure A-36: ORC Market Evolution A-48

Figure A-37: Projected Future Costs and Cumulative Global Capacity A-51

Figure A-38: Wind Turbine Components A-52

Figure A-39: Scale of Wind Turbines..... A-53

Figure A-40: Annual and Cumulative U.S. Capacity A-54

Figure A-41: 50 kW Wind System Growth Rate A-61

Figure A-42: 1,500 kW Wind System Growth Rate A-61

Figure A-43: 50 kW Wind System Learning Curve A-63

Figure A-44: Log-log 50 kW Wind System Learning Curve..... A-63

Figure A-45: 1,500 kW Wind System Learning Curve A-64

Figure A-46: Projected Future Costs A-65

Figure A-47: Storage Technologies A-66

Figure A-48: Fraction of Projects by Type of Storage A-67

Figure A-49: Lithium-Ion Battery Chemistry A-68

Figure A-50: SGIP Storage Charge & Discharge Timing (Case Study of TOU Load Shifting)..... A-70

Figure A-51: Battery Use Case for Peak Demand Reduction in April A-71

Figure A-52: Battery Use Case for Peak Demand Reduction in July A-72

Figure A-53: Actual Storage Demand Reduction A-72

Figure A-54: Averaged Non-Zero Storage Discharge (Before Application of 0.8 Demand Savings Ratio) A-74

Figure A-55: Future Costs on \$/kW and \$/kWh Basis A-78

Figure A-56: Typical Pressure Reduction Turbine Configuration A-79

Figure A-57: Projected Future Pressure Reduction Turbine Costs & Cumulative Capacity A-82

Figure B-1: Aeroderivative Combustion Turbine Instant Capital Costs B-3

Figure D-1: Structure of SGIPCE Model D-2



Figure D-2: SGIPCE Directory Structure D-7

Figure D-3: SGIPCE Control Worksheet D-7

Figure D-4: Global Assumptions D-8

Figure D-5: Technology Definitions D-10

Figure D-6: Technology Definitions (continued) D-11

Figure D-7: SGIPCE Buttons D-12

Figure D-8: Error Log D-14

Figure D-9: Calculation Engine Cover Sheet D-16

Figure D-10: Results Page Example D-17

Figure D-11: LCOE Proforma Sheet Example D-17

Figure D-12: Annual Inputs Table Example D-18

Figure D-13: Technology-Level Constants Example D-19

Figure D-14: Technology-Level Annual Inputs Example D-20

Figure D-15: Global Finance Inputs D-20

Figure D-16: Results Cover Example D-21

Figure D-17: Results Adoption Sheet Example D-22

Figure D-18: Summary Stats per Unit Example D-22

Figure D-19: Summary Stats Total Example D-23

Figure D-20: Technology Definitions Table D-24

LIST OF TABLES

Table 2-1: Comparison of Technologies EVALUTED in 2011 and 2015 Studies	2-4
Table 3-1: Evaluated SGIP Technologies, Fuels, and Nominal Capacities	3-3
Table 3-2: DER Projects and Capacity in California at 12/31/2014.....	3-4
Table 4-1: Summary of Benefits Allocated by Cost Tests	4-5
Table 4-2: Summary of Costs Allocated by Cost Tests	4-6
Table 4-3: Progress Ratios for Evaluated SGIP Technologies.....	4-9
Table 4-4: Summary of Operating Characteristics of SGIP Technologies	4-13
Table 4-5: Emission Factors for SGIP Technologies	4-14
Table 4-6: Weighted Electrical IOU Rates 2011-2034 (Nominal \$/kWh)	4-22
Table 4-7: Example of Average Weighted Electricity Rates by SGIP Technology	4-22
Table 4-8: Non-Core Gas Rates Over Time 2012-2035 (Nominal \$/Therm)	4-23
Table 4-9: Incentive Levels under the SGIP	4-23
Table 4-10: Incentive Rate Tiers	4-24
Table 4-11: Rate of Incentive Decline	4-24
Table 4-12: CO ₂ Emission Values 2010–2034 (Nominal \$ Per Ton of CO ₂)	4-25
Table 4-13: ITC and Depreciation Terms Allocated to SGIP Technologies.....	4-26
Table 4-14: Summary of Departing Load Exemptions by SGIP Technology and Fuel	4-27
Table 5-1: Representative PCT Cost and Benefit Table Summary Results.....	5-5
Table 6-1: Statewide Summary of Commercial Sector STRC Results for 2014 and 2020 (No Incentives)	6-12
Table 6-2: STRC Test Levelized Cost and Benefits for Non-Combustible SGIP Technologies, PG&E Territory, No Rebate, 2014.....	6-16
Table 6-3: STRC Test Levelized Cost and Benefits for Natural Gas SGIP Technologies, PG&E Territory, No Incentive, 2014	6-27
Table 6-4: STRC Costs and Benefits for 7 MW Gas Turbine Fueled by Natural Gas, No Incentives.....	6-32
Table 6-5: STRC Test Levelized Cost and Benefits for Onsite Biogas Technologies, PG&E Territory, No Incentive, 2014	6-47
Table 6-6: Statewide Summary of Commercial Sector PCT Results for 2014, No Incentives	6-56
Table 6-7: Breakdown of Costs and Benefits for 30 kW Storage System Participant Test in SDG&E Territory	6-61
Table 6-8: Breakdown of Costs and Benefits for 400 kW PRT System PCT in PG&E Territory.....	6-70
Table 6-9: Breakdown of Costs and Benefits for 500 kW ORC System PCT in PG&E Territory.....	6-72
Table 6-10: Statewide Summary of Commercial Sector PA Test Results for 2014 and 2020	6-111
Table A-1: Production Volumes for 500 kW IC Engines	A-3
Table A-2: Estimated Installed Costs of 500 kW IC Engines 2006 to 2013 in 2013\$.....	A-4
Table A-3: Estimated Biogas Cleanup and Collection Costs.....	A-7



Table A-4: Representative Fuel Cell Electrical Conversion Efficiencies A-10

Table A-5: Maximum Fuel Cell Heat Output A-10

Table A-6: Fuel Cell Air Pollutant Emission Rates A-11

Table A-7: Fuel Cell Cost Estimates A-14

Table A-8: Gas Turbine Electrical Efficiencies for Typical 7,000 kW Systems A-19

Table A-9: Average Gas Turbine Air Pollutant Emissions Rates” A-19

Table A-10: Gas Turbine Capital Cost Estimates A-22

Table A-11: Representative IC Engine Electrical Conversion Efficiencies A-28

Table A-12: IC Engine Useful Heat Recovery Rate A-29

Table A-13: Average IC Engines Air Pollutant Emission Rates” A-30

Table A-14: IC Engine Cost Estimates A-33

Table A-15: Microturbine Electrical Conversion Efficiency A-40

Table A-16: Microturbine Useful Heat Recovery Rate A-40

Table A-17: Microturbine Air Pollutant Emissions Rates’ A-41

Table A-18: Cost Estimates A-43

Table A-19: ORC Cost Estimates A-50

Table A-20: 50kW Wind System Cost Estimates A-58

Table A-21: 1,500 kW Wind System Cost Estimates A-59

Table A-22: Storage Cost Estimates A-76

Table A-23: Pressure Reduction Turbine Cost Estimates A-81

Table A-24: List of Technology Learning Rates and Progress Ratios A-83

Table B-1: Aeroderivative Combustion Turbine Performance Characteristics B-2

Table B-2: Aeroderivative Combustion Turbine Costs B-4

Table B-3: Combined Cycle Gas Turbine Performance Characteristics B-5

Table B-4: Combined Cycle Gas Turbine Costs B-6

Table E-1: Nomenclature Used in Cost & Benefit Equations E-1

Table E-2: Participant Costs E-2

Table E-3: SGIP Technology System Costs & O&M Costs (2014 Basis) E-6

Table E-4: Representative Non-bypassable Charges E-7

Table E-5: Participant Benefits E-8

Table E-6: Societal Costs E-13

Table E-7: Societal Benefits E-16

Table E-8: Program Administrator Costs E-20

Table E-9: Program Administrator Benefits E-21

GLOSSARY

Term	Definition
<i>Global Terms</i>	
BOP	Balance of plant
CAISO	California independent System Operator
CEC	California Energy Commission
CSE	Center for Sustainable Energy
CPUC	California Public Utilities Commission
HHV	Higher Heating Value
IOU	Investor-owned utility
NEM	Net energy metering
PA	Program Administrator
PG&E	Pacific Gas & Electric
PY	Program year
SCE	Southern California Edison Company
SCG	Southern California Gas Company
SDG&E	San Diego Gas & Electric Company
SGIP	Self-Generation Incentive Program
<i>Technologies</i>	
AES	Advanced energy storage
CHP	Combined heat and power
DER	Distributed energy resource
DG	Distributed generation
FC	Fuel cell
GT	Gas turbine
IC engine	Internal combustion engine
MT	Microturbines
ORC	Organic rankine cycle
PRT	Pressure reduction turbine
PV	Photovoltaic
WD	Wind turbine
<i>Economics/Financing</i>	
EPBB	expected performance based buydown
LCOE	levelized cost of energy



Term	Definition
MIRR	modified internal rate of return
PAC	Program administrator cost test
PBI	performance based incentive
PCT	participant cost test
PPA	power purchase agreement
STRC	societal total resource cost
TRC	total resource cost
<i>Emissions/Benefits</i>	
GHG	greenhouse gas
CO ₂ eq	CO ₂ equivalent
NO _x	Nitric oxide (NO) and nitrogen dioxide (NO ₂)
PM ₁₀	Particulate matter (PM) with diameter of 10 micrometers or less
SO ₂	Sulfur Dioxide
REC	renewable energy credit
<i>SGIPce Modeling Technologies</i>	
DIRBGas	directed biogas
GNP	government/non-profit
NG	natural gas
NR	non-residential
OSB	on-site biogas
<i>MODEL DESIGNATIONS</i>	
<i>Fuel Cell - CHP</i>	
FC500kW_NR_DIRBGas	500 kW, Non-Residential, Directed Biogas Fuel Cell (CHP)
FC500kW_NR_NG	500 kW, Non-Residential, Natural Gas Fuel Cell (CHP)
FC500kW_NR_OSBCGas	500 kW, Non-Residential, Onsite Biogas Fuel Cell (CHP)
FC1200kW_NR_DIRBGas	1.2 MW, Non-Residential, Directed Biogas Fuel Cell (CHP)
FC1200kW_NR_NG	1.2 MW, Non-Residential, Natural Gas Fuel Cell (CHP)
FC1200kW_NR_OSBCGas	1.2 MW, Non-Residential, Onsite Biogas Fuel Cell (CHP)
<i>Fuel Cell – Electric Only</i>	
FC500kWe_NR_DIRBGas	500 kW, Non-Residential, Directed Biogas Fuel Cell (Electric Only)
FC500kWe_NR_NG	500 kW, Non-Residential, Natural Gas Fuel Cell (Electric Only)
FC500kWe_NR_OSBCGas	500 kW, Non-Residential, Onsite Biogas Fuel Cell (Electric Only)



Term	Definition
<i>Gas Turbine</i>	
GTg3to7MW_NR_DIRBGas	3 to 7 MW, Non-Residential, Directed Biogas Gas Turbine; treated nominally as 7 MW
GTg3to7MW_NR_NG	3 to 7 MW, Non-Residential, Natural Gas, Gas Turbine; treated nominally as 7 MW
GTg3to7MW_NR_OSBGas	3 to 7 MW, Non-Residential, Onsite Biogas, Gas Turbine; treated nominally as 7 MW
GTle3MW_NR_DIRBGas	less than 3 MW, Non-Residential, Directed Biogas, Gas Turbine; treated nominally as 2.5 MW
GTle3MW_NR_NG	less than 3 MW, Non-Residential, Natural Gas, Gas Turbine; treated nominally as 2.5 MW
GTle3MW_NR_OSBGas	less than 3 MW, Non-Residential, Onsite Biogas, Gas Turbine; treated nominally as 2.5 MW
<i>Internal Combustion (IC) Engine</i>	
ICE500kW_NR_DIRBGas	500 kW, Non-Residential, Directed Biogas, IC engine
ICE500kW_NR_NG	500 kW, Non-Residential, Natural Gas, IC engine
ICE500kW_NR_OSBGas	500 kW, Non-Residential, Onsite Biogas, IC engine
ICE1500kW_NR_DIRBGas	1500 kW, Non-Residential, Directed Biogas, IC engine
ICE1500kW_NR_NG	1500 kW, Non-Residential, Natural Gas, IC engine
ICE1500kW_NR_OSBGas	1500 kW, Non-Residential, Onsite Biogas, IC engine
<i>Microturbine</i>	
MT200kW_NR_DIRBGas	200 kW, Non-Residential, Directed Biogas, Microturbine
MT200kW_NR_NG	200 kW, Non-Residential, Natural Gas, Microturbine
MT200kW_NR_OSBGas	200 kW, Non-Residential, Onsite Biogas, Microturbine
<i>Organic Rankine Cycle (ORC)</i>	
ORC500kW_NR_NA	500 kW, Non-Residential, No Fuel Specified, Organic Rankine Cycle
<i>Pressure Reduction Turbine (PRT)</i>	
PRT500kW_NR_NA	500 kW, Non-Residential, No Fuel Specified, Pressure Reduction Turbine
<i>Storage</i>	
Storage5kW_Res_NA	5 kW, Residential, No Fuel Specified, Storage
Storage30kW_NR_NA	30 kW, Non-Residential, No Fuel Specified, Storage
Storage5MW_NR_NA	5 MW, Non-Residential, No Fuel Specified, Storage
<i>Wind</i>	
WD50kW_Res_NA	50 kW, Residential, No Fuel, Wind
WD1500kW_NR_NA	1.5 MW, Non-Residential, No Fuel, Wind

1 EXECUTIVE SUMMARY

Distributed generation and storage technologies are playing an increasing role in the electricity system. As more distributed generation and storage systems improve their cost effectiveness and market acceptance, it will force policy makers, utility managers, and energy planners to make decisions about investing in these technologies. These investment decisions are not straight forward. There is a variety of distributed generation and storage technologies, each with different costs and benefits. In addition, the relationship between who pays and who benefits from investments in these technologies is complex. California's Self-Generation Incentive Program (SGIP) has over fourteen years of experience with installation and operation of a variety of distributed generation and storage technologies. Using cost effectiveness calculations, this report describes the costs and benefits of SGIP-eligible technologies from multiple stakeholder perspectives, including participants (Participant Cost Test), utilities (Program Administrator Cost Test), the combined perspective of participants and non-participants (Total Resource Cost Test), and society at large (Societal Total Resource Cost Test).¹

Cost effectiveness analysis can provide a clear and consistent framework for comparing the value of competing distributed generation and storage technologies against one another and against conventional grid resources. Cost effectiveness analysis also explicitly identifies the costs of resources and the associated benefits resulting from their use.

The purpose of the 2015 SGIP Cost Effectiveness Study is to deliver a model that can be used in assessing the cost effectiveness of different distributed generation and storage technologies and to provide the results of a cost effectiveness evaluation of those technologies implemented using the model. The focus on this study is on SGIP technologies implemented between 2014 and 2034. This study updates and expands on a distributed generation cost effectiveness evaluation completed in January 2011.²

Distributed generation and storage technologies evaluated in this study can be viewed as consisting of a number of different technologies interconnected to the grid in an assortment of ways. However, distributed generation and storage technologies deployed under California's Self-Generation Incentive Program (SGIP) make up the focus of this study. For the purposes of this report, we evaluate the cost effectiveness of selected distributed generation and storage technologies eligible under the SGIP as of calendar year 2014.

¹ For this report, the Total Resource Cost Test (TRC) and the Societal Total Resource Cost (STRC) Test are calculated using similar inputs except for the discount rate applied to future benefits and costs. The TRC uses the utility's discount rate (7.5%) while the STRC uses a lower, societal discount rate (5%).

² California Public Utilities Commission, *Cost effectiveness of Distributed Generation Technologies*, Itron, February 9, 2011.



Cost effectiveness of SGIP technologies are evaluated in this study following guidelines set forth in an August 2009 California Public Utilities Commission (CPUC) adopted decision on cost-benefit methodology for DG technologies.³

1.1 COST TESTS FOR SGIP TECHNOLOGY EVALUATION

SGIP technology cost effectiveness is evaluated from four perspectives: all utility customers (participants and non-participants), society, participants, and Program Administrators (PAs).⁴ Based originally on the cost tests used for evaluating energy efficiency programs, these cost tests have been modified in accordance with the CPUC's 2009 adopted methodology to be applicable to distributed generation and storage technologies.

The Total Resource Cost (TRC) test treats the program measures as a series of resource options. The test measures the net benefits and costs of a program and/or measure that accrue to all utility customers, both participants and non-participants. The TRC benefits are largely the avoided electric and gas costs, but include federal tax benefits or credits. The TRC costs are the costs associated with program administration, the customer measures, and increased operating costs. The TRC does not include the cost of incentives. The TRC test examines the value of the program as another way to achieve certain utility or policy goals. A positive TRC or a TRC ratio greater than 1.0 indicates that the program or measure is estimated to produce a net benefit in the utility territory over the life of the measure.

The societal version of the Total Resource Cost (STRC) test looks at the overall cost effectiveness of SGIP technologies to society at large. The societal test is similar to the TRC except it uses the societal discount rate (a lower discount rate than the utility discount rate used in the TRC).⁵ If the ratio of the STRC benefits-to-costs exceeds 1.0, the benefits to society exceed the costs in implementing the SGIP technology.

Note that the TRC and STRC provide very similar results in this analysis. In California, both the STRC and TRC tests take into account monetary values for emissions.⁶ The only difference between the STRC and TRC is the discount rate used in the tests.⁷ While the model generates results for both the TRC and STRC,

3 California Public Utilities Commission, "Decision Adopting Cost-Benefit Methodology for Distributed Generation," Decision 09-08-026, August 2009

4 The CPUC specifically excludes use of the Ratepayer Impact Measure (RIM) test in evaluating the cost effectiveness of DG technologies in its decision on cost-benefit methodology (see D.09-08-026, pg. 25) and that has been expanded to this DG and AES cost effectiveness evaluation.

5 Neither the TRC nor the STRC includes utility incentives as a benefit or a cost. From society's point of view, a rebate is a transfer from one person to another and, therefore, does not change society's benefits or costs.

6 The monetary values for emissions are derived from the E3 Avoided Cost Model dated May, 21 2015. The cost of carbon in this model is based on CO₂ prices from the 2014-2030 CPUC MPR Forecast. In 2014, the CO₂ price is \$22.50/ton, increasing to \$36.97/ton in 2020. The NO_x price is \$6.40/lb in 2014 and \$12.47/lb in 2020.

7 The discount rate used in the STRC is 5% and in the TRC is 7.5%.



we focus primarily on STRC results. This has been done so as to remain consistent with the methodology used in the 2011 SGIP cost effectiveness report.

The Participant Cost test (PCT) examines the cost effectiveness of the SGIP technology to the participant. Examples of participant benefits include electricity and gas bill savings, favorable tax treatment, or new revenue streams including utility rebates. Participant costs include increased capital outlay associated with the technology, increased operating and maintenance (O&M) costs, and fueling costs. If the benefits outweigh the costs, the technology is considered cost effective to the participant.

The Program Administrator Cost (PAC) test examines the cost effectiveness of SGIP technologies from the utility perspective (noting that these costs and benefits are passed on to ratepayers).⁸ It compares the net costs of participant projects (i.e., the PA costs and incentives) to other supply-side resource options available to the utility. It takes into account the costs incurred by the PAs (including incentive costs) and excludes participant costs. The PAC represents the utility's perspective (and the perspective of the utility's customers) on the net value of implementing the portfolio of projects making up the SGIP.

SGIP technologies evaluated under these cost effectiveness tests include technologies eligible under the SGIP through the end of 2014.^{9,10} Taking into account different fuel types, this study examines the cost effectiveness of 31 different configurations of SGIP technologies including stand-alone AES systems, wind turbines, fossil-fueled as well as biogas-fueled internal combustion (IC) engines, microturbines, small-scale gas turbines and fuel cells, pressure reduction turbines (PRT), and Organic Rankine Cycle (ORC) systems.¹¹ Descriptions of the evaluated technologies, their operating characteristics, and costs are contained in Appendix A.

Fossil-fueled technologies, other than all-electric fuel cells, are treated as having combined heat and power (CHP) capabilities.¹² Under the SGIP Handbook guidelines, technologies fueled by directed biogas or onsite biogas are not required to recover waste heat.¹³ Consequently, for the cost effectiveness results presented in this report, only the natural gas-fueled technologies are modeled with CHP capabilities.

⁸ The study does not provide cost effectiveness results for Southern California Gas Company (SCG) even though SCG is very active in the SGIP. Due to the way in which core and non-core gas costs and prices are handled in the model, it is not possible to generate comparable gas-based cost effectiveness results for SCG.

⁹ The exception is solar photovoltaic (PV), which was eligible as a technology under the SGIP prior to January 1, 2007. However, in accordance with CPUC Decision-06-01-047, solar PV technologies were transitioned to the California Solar Initiative effective January 1, 2007.

¹⁰ Cost effectiveness of solar PV technologies is examined in the CPUC report *California Solar Initiative Cost Effectiveness Evaluation*, April 2011.

¹¹ The 31 different configurations are shown explicitly in Table 3-1 in Section 3.

¹² CHP refers to the production of both electric power and heat, which can be used to meet onsite electrical and thermal needs. CHP systems typically use waste heat recovery systems to capture heat generated from the power production process.

¹³ *2014 Self-Generation Incentive Handbook*, Section 4.2.7, "Minimum Operating Efficiency Requirements," pg. 44, January 1, 2014.



We have developed an updated cost effectiveness model (the “2014 SGIP Cost Effectiveness Model” or “2014 SGIPce”) and use it in assessing cost effectiveness for currently eligible SGIP technologies. The model combines SGIP technology cost, performance, and financial and environmental information along with utility rate and avoided cost information. The model calculates results at the technology level as well as at utility and statewide levels. The cost-benefit results are presented in four different snapshots over time: 2014, 2017, 2020, and 2024. Individual cost and benefit components are illustrated in charts and listed in corresponding tables. The data are provided in ways to help identify the underlying causes and trends that produce specific cost effectiveness results.

1.2 KEY FINDINGS

Societal Test Results

We examine the STRC results of commercial-sector SGIP technologies at two years: 2014 (the “current” time period) and 2020 (when the SGIP is scheduled to expire).¹⁴ Figure 1-1 illustrates a summary of the STRC results for all the evaluated commercial sector SGIP technologies at 2020 without incentives. Note that the solid horizontal line represents a benefit-cost ratio of 1.0, where an STRC of 1.0 or greater implies that the benefits exceed the costs of the SGIP technology to society. The future path of expected benefits and costs for these technologies, however, is uncertain. Given this uncertainty, and the potential non-economic benefits associated with facilitating the market for SGIP technologies, it also makes sense to view STRC benefit-cost ratios at a lower threshold. In this instance, we have used a lower STRC threshold of 0.8.¹⁵ The dotted horizontal line in Figure 1-1 represents the lower STRC benefit-cost ratio of 0.8.

Review of the results in Figure 1-1 shows the following:

- » Nearly all (18 out of 26) of the evaluated SGIP technologies pass the lower STRC benefit-cost ratio of 0.8 by 2020.
- » SGIP technologies with an STRC benefit-cost ratio less than 0.8 in 2020 include microturbines fueled by natural gas or directed biogas, fuel cells with CHP capabilities fueled by natural gas or directed biogas, the electric-only fuel cells regardless of the fuel source; and the large storage (5 MW) technology.

¹⁴ To be consistent with the 2011 Cost Effectiveness study results, we look only at commercial sector results for key findings. Residential sector results are discussed in Section 5.

¹⁵ High uncertainty bounds are not unheard of in cost effectiveness analysis. For example, the *2008 California Statewide Potential Study* used a TRC test of 85% to determine eligibility for program rebates. The primary focus of the Statewide Potential Study was to develop the gross and net potential estimates for electricity and gas savings in the existing and new residential, commercial, and industrial sectors. In general, the uncertainty of energy efficiency measures may be less than the uncertainty of SGIP technologies due to the shorter expected useful life of energy efficiency measures when compared to SGIP technologies. A copy of the *2008 Statewide Potential Study* can be downloaded from <http://www.cpuc.ca.gov/NR/rdonlyres/F8F8F799-40A8-4856-869F-713D6E6FF5E0/0/2008CaliforniaEnergyEfficiencyPotentialStudy.pdf>

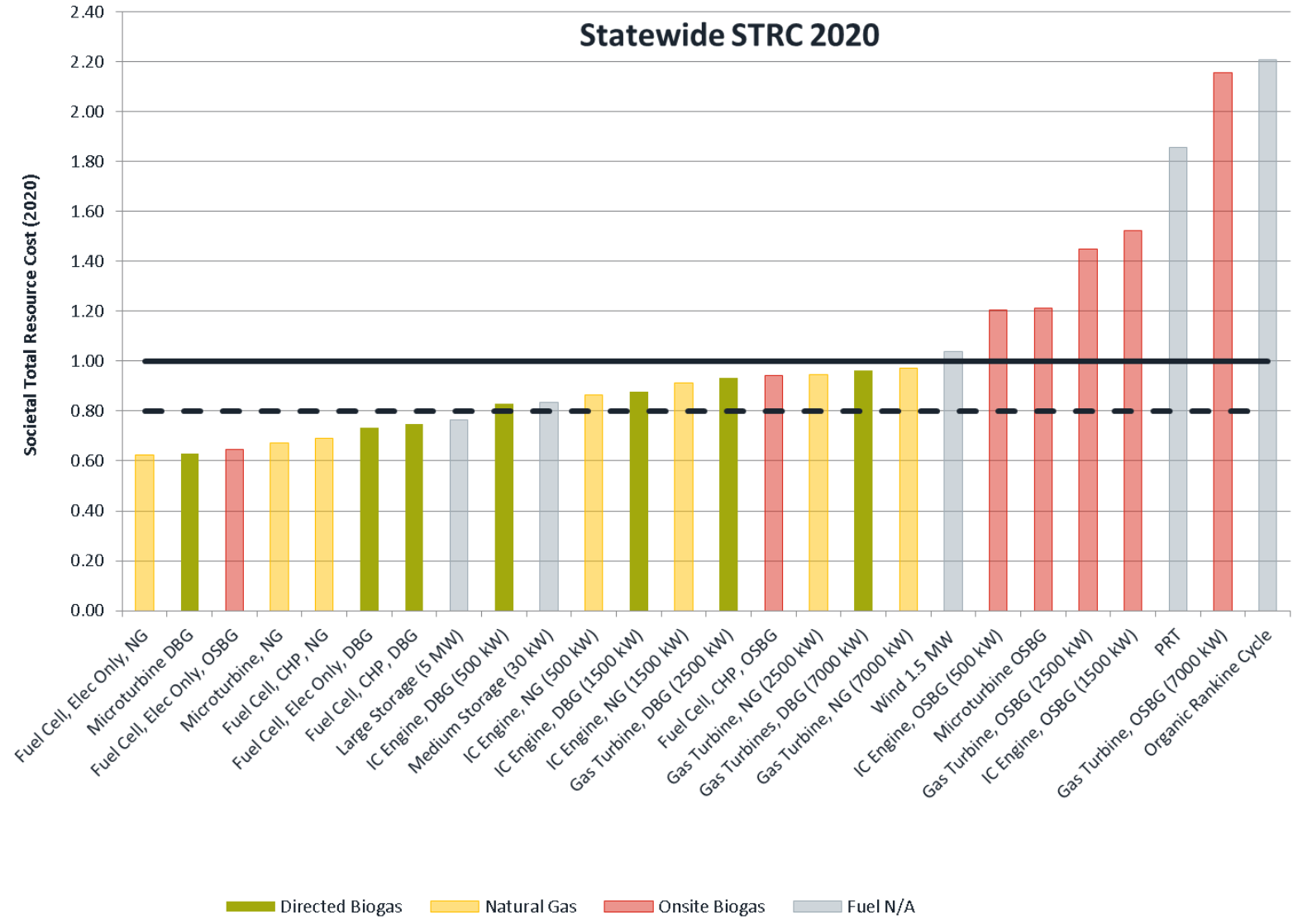


- » Eight of the evaluated SGIP technologies had STRC benefit-cost ratios greater than 1.0. Factors that contribute to these high STRC benefit-cost ratios include no fueling costs, favorable tax treatment, and additional revenue streams (e.g., Renewable Energy Credits).

Detailed results on each technology are provided in Section 6 of the report.



FIGURE 1-1: STATEWIDE SOCIETAL TOTAL RESOURCE COST (STRC) TEST RESULTS WITHOUT INCENTIVES AT 2020





Participant Cost Test Results

The 2014 PCT results are important in that they help identify SGIP technologies that may not currently be cost effective to participants and, therefore, could benefit from incentives to help overcome market risks and barriers.

The 2014 SGIPce model generates the costs and benefits necessary to calculate the PCT by SGIP technology, electric investor-owned utility (IOU) service territory, market sector (e.g., residential, commercial, or government/non-profit) and geographical region (i.e., inland or coastal). As with STRC results, detailed PCT results for each evaluated SGIP technology can be found in Section 6 of the report.

Figure 1-2 provides a summary snapshot of the PCT results in 2014 for commercial sector SGIP technologies without incentives. Similar to the 2020 STRC results, a solid horizontal line shows the benefit-cost threshold of 1.0. However, instead of a dotted line located across the chart at a benefit-cost ratio of 0.8, the PCT dotted line is located at a benefit-to-cost ratio of 1.2. Measures with a PCT larger than 1.0 are estimated to have participant benefits greater than their participant costs. Risks and uncertainty may limit adoption of these measures. A higher PCT threshold of 1.2, however, may have sufficiently high benefit-cost ratios to help overcome market barriers, risks, and uncertainty borne by participants.

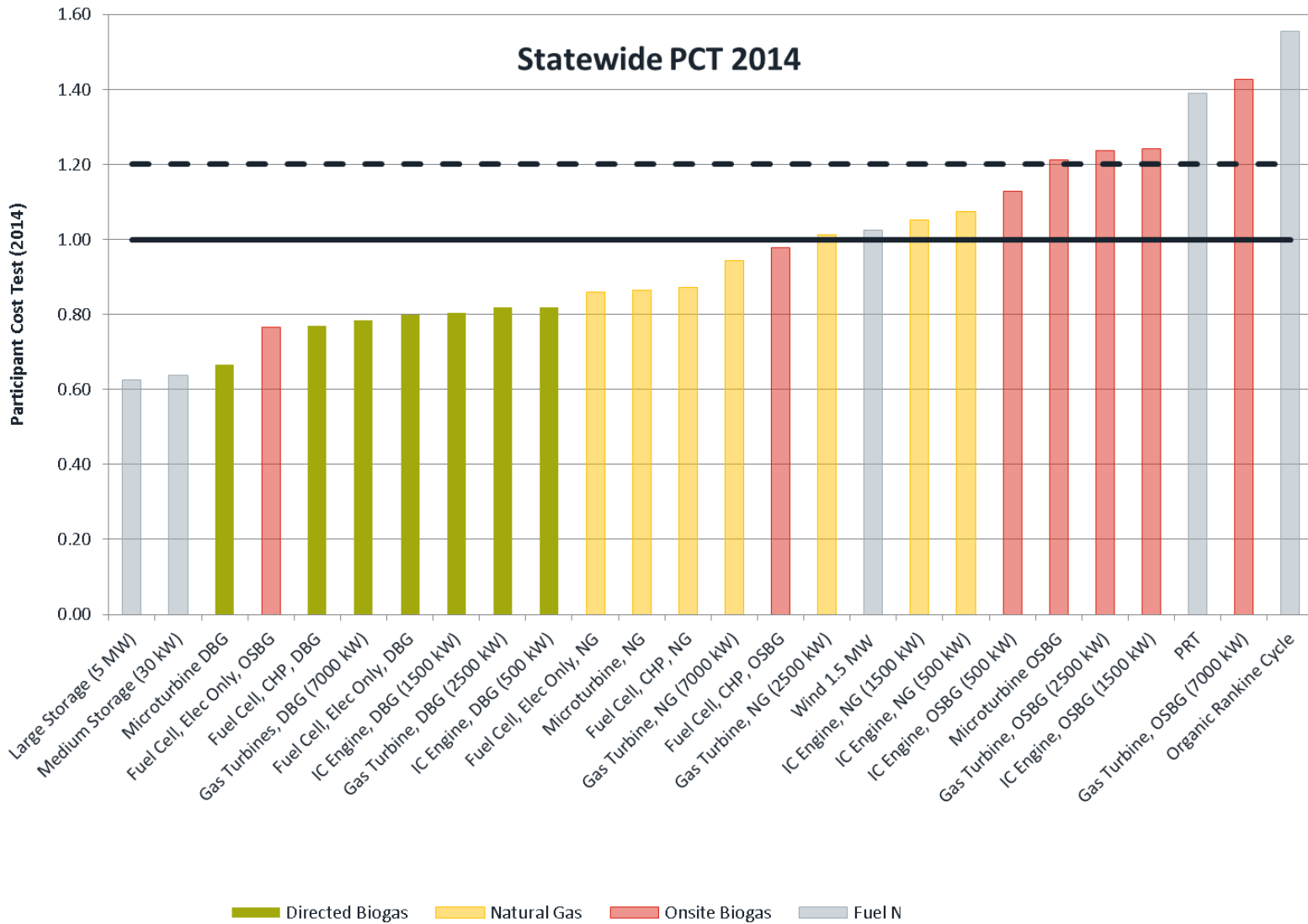
Key findings relative to the PCT include the following:

- » All but six of the SGIP technologies have 2014 PCT benefit-cost ratios less than or equal to 1.2. The technologies that had PCT benefit-cost ratios greater than 1.2 include:
 - > Certain SGIP technologies fueled by onsite biogas, including the 200 kW microturbine, both the 2.5 MW and 7 MW gas turbines, and the 1.5 MW IC engine.
 - > Both PRT and ORC technologies, which have no fueling costs.
- » SGIP technologies showing the highest PCT benefit-cost ratios are generally those without fueling costs.¹⁶ With the exception of the electric-only fuel cells, this includes all SGIP technologies fueled by onsite biogas, wind energy systems, and PRT and ORC technologies.

¹⁶ Natural gas fueled technologies such as the 2.5 MW gas turbine and 1.5 MW IC engine also have high PCT ratios, due largely to increased bill savings tied to lower cost natural gas.



FIGURE 1-2: STATEWIDE PARTICIPANT COST TEST (PCT) RESULTS WITHOUT INCENTIVES AT 2014





Combined STRC and PCT Results

The combined STRC and PCT results provide valuable insights. The combined results identify the cross section of SGIP technologies that potentially provide high benefits to society in 2020 but that may not be cost effective to participants in 2014.

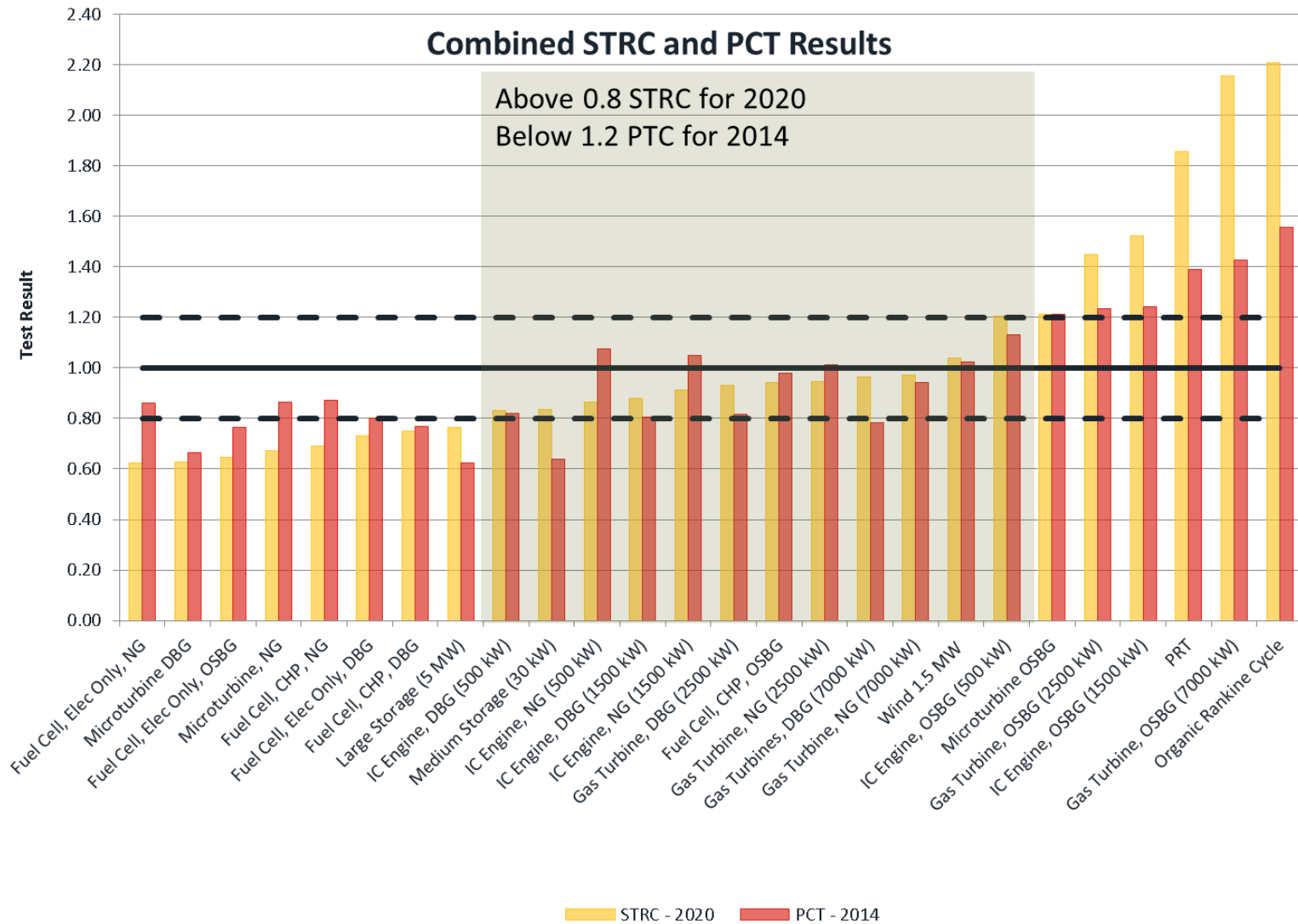
Figure 1-3 shows the combined 2020 STRC and 2014 PCT results without incentives. A grey border identifies those SGIP technologies with 2020 STRC benefit-to-cost ratios greater than or equal to 0.8 and that also have 2014 PCT benefit-to-cost ratios less than or equal to 1.2. This subset of SGIP technologies represents those SGIP technologies that should ideally be targeted to receiving incentives, having both potentially high societal values in 2020 and facing market barriers in 2014 that may prevent them from achieving those high societal benefits.

SGIP technologies that fall into this subset include:

- » The 500 kW IC engines regardless if fueled by natural gas, directed biogas, or onsite biogas; and the 1.5 MW IC engines fueled by natural gas or directed biogas.
- » Both the 2.5 MW and 7 MW gas turbine if fueled by natural gas, or directed biogas.
- » The 500 kW CHP fuel cell fueled by onsite biogas.
- » The 30 kW AES and the 1.5 MW wind energy technologies.



FIGURE 1-3: COMBINED STATEWIDE 2020 STRC AND 2014 PCT RESULTS WITHOUT INCENTIVES





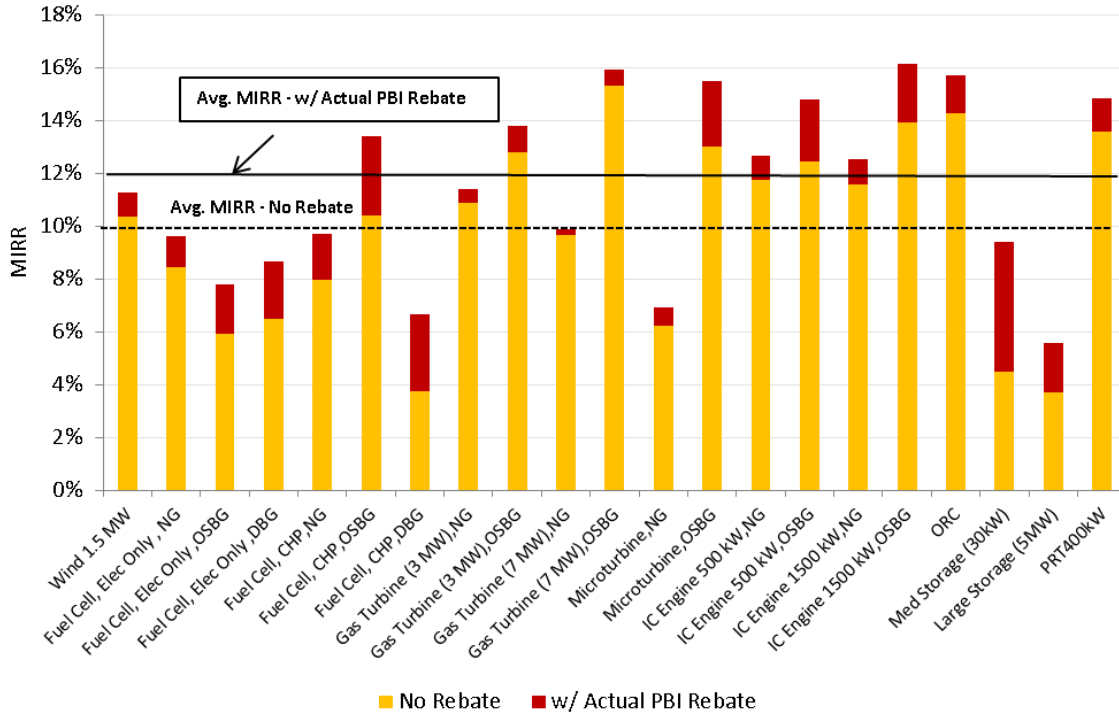
Results on Modified Internal Rate of Return

Modified internal rate of return (MIRR) represents the financial value of investments, with a higher MIRR reflecting a better investment. The 2014 SGIPce model generates MIRR values that correspond to the PCT benefit-cost results. In particular, MIRR values can be produced for each SGIP technology that reflects the financial return to the participant when there is no incentive being provided and at different levels of incentives. In general, higher incentive levels will correspond to higher financial returns to the participant. Policy makers face the question of how much incentive should be provided to different technologies. MIRR analysis helps to provide some insights into how different incentive levels may affect the financial returns to participants.

The MIRR analysis allows targeting of incentive levels to help create a “level playing field.” For technologies with equivalent risks, the MIRR feature of the 2014 SGIPce model can be used to calculate incentive levels that provide the same MIRR for the different SGIP technologies analyzed for this study.

Figure 1-4 summarizes the MIRR results that correspond to SGIP technologies without incentives and with levels of incentives expected in SGIP in 2014. We have only presented those SGIP technologies that had MIRR values greater than zero without incentives in 2014.¹⁷

FIGURE 1-4: COMPARISON OF MIRR FOR SGIP SYSTEMS WITHOUT INCENTIVES AND WITH 2014 INCENTIVES



¹⁷ MIRR analyses are inherently tied to existing incentive levels so as to benchmark them. Consequently, we only present MIRR results at 2014 for this summary table.



The dotted line represents the average MIRR value (approximately 10%) across the evaluated SGIP technologies when incentives are not provided.¹⁸ The solid line represents the average MIRR value (approximately 12%) when those same SGIP technologies received incentive levels expected within SGIP in 2014. Note that technologies estimated to have a relatively high PCT without incentives (see Figure 1-2) are also shown to have a relatively high MIRR (see Figure 1-4).

Policy makers can use the MIRR results to estimate incentive levels for SGIP technologies necessary to reach a given return. If a MIRR value of 12% is determined to be the target level, the SGIPce model can provide a corresponding incentive level that matches the target MIRR.¹⁹ While the MIRR analysis helps identify possible incentive levels that match target MIRR values, ultimately the selection of incentive values is a policy decision that must take into account market risk and uncertainty that cannot be captured accurately by the model.

Program Administrator Cost (PAC) Results

Figure 1-5 depicts the PAC test results for SGIP systems evaluated at the statewide level for 2014 and 2020. The results are weighted by electricity sales for each of the three major electrical IOUs.²⁰ The 2014 results are presented using SGIP program incentives for 2014 as specified in the SGIP Handbook. The 2020 results use incentive levels forecast out to 2020 based on existing SGIP Handbook guidelines regarding annual declines in incentive levels by technology.

The results presented in Figure 1-5 show that all evaluated SGIP technologies other than stand-alone energy storage have PAC benefit-cost ratios significantly higher than 1. These high PAC benefit to cost ratios result largely due to two factors occurring concurrently: high avoided electricity cost benefits being generated at the same time the technology has low or zero fueling costs.²¹ As the avoided electricity costs (in the numerator) increase simultaneously with the fuel costs (in the denominator) dropping, the difference creates large benefit to cost ratios.

In addition, Figure 1-5 indicates that larger sized technologies in general have higher benefit to cost ratios. This results because the larger technologies provide a disproportionality greater amount of benefit generated for each dollar of incentive paid out to the technology. The SGIP reduces the amount of incentive paid as the rebated capacity of the technology increases. However, the benefits produced and allocated to the SGIP remain proportional to the total rebated capacity. Consequently, the larger sized technologies generate a greater amount of benefits than their smaller counterparts relative to the amount

¹⁸ The 10% MIRR does not include the MIRR for technologies whose MIRR is zero or negative without an incentive. The average MIRR is calculated as an arithmetic average giving each technology equal weight.

¹⁹ The SGIPce model can generate incentive levels needed to achieve many different MIRR levels.

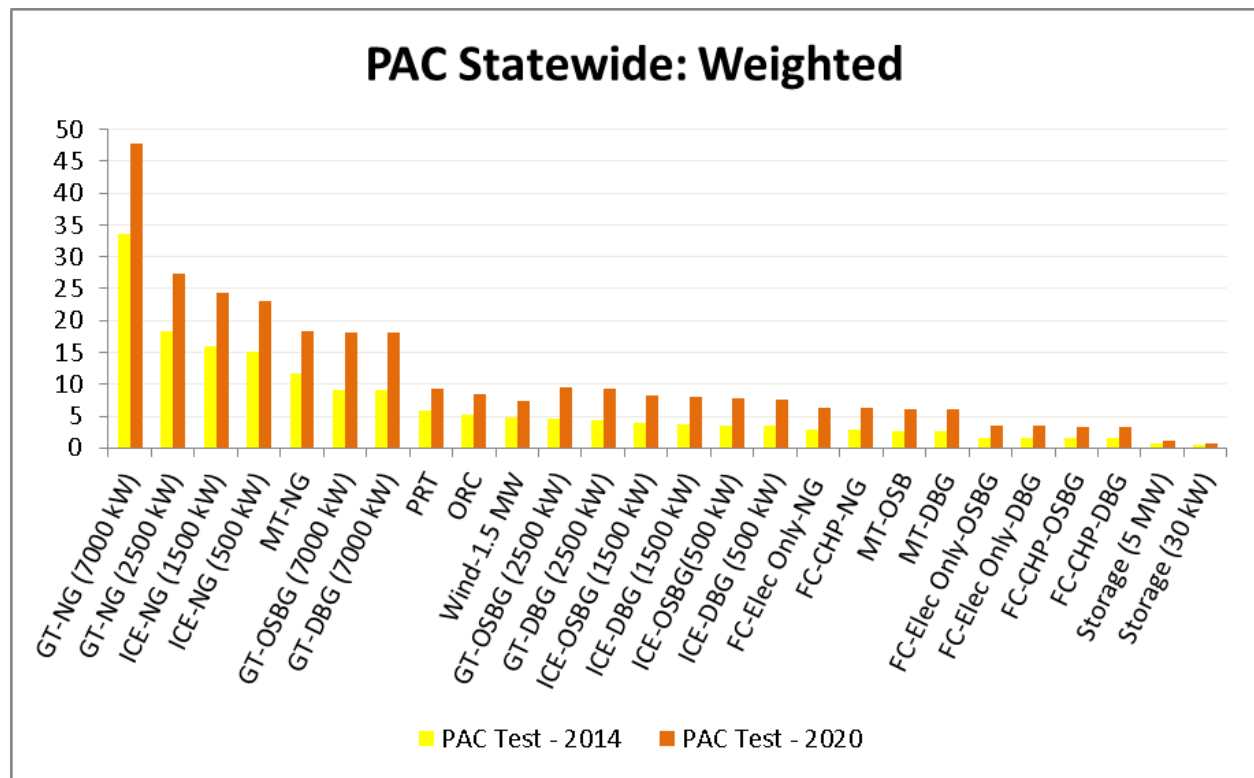
²⁰ A more complete breakout of the PAC results showing individual PA results is shown in Table 6-10 in the main body of the report.

²¹ Note that while natural gas prices are currently low and forecast to remain low, we have also assumed that most commercial customers are not purchasing natural gas from the utility but purchasing it through gas marketers or other channels.

of incentive paid to the technology. The net result is that larger capacity SGIP technologies (which generate commensurately higher avoided cost benefits) with low or zero fuel costs and low incentive levels result in very high PAC benefit-to-cost ratios.

Stand-alone storage has lower PAC benefit-to-cost ratios. In the case of the modeled 5 MW system, the 2014 and 2020 ratios are 0.81 and 1.10, respectively. For the 30 kW system, the 2014 and 2020 ratios are 0.41 and 0.71, respectively. In general, stand-alone storage shows lower PAC benefit-to-cost ratios due to the lower amount of electricity system benefits (storage is only displacing electricity over a portion of the year and the demand reductions are only pronounced in the SDG&E service territory), there are “fueling” costs associated with charging the storage system and the incentives paid out to storage tend to be higher than for the other SGIP technologies.

FIGURE 1-5: PROGRAM ADMINISTRATOR COST RESULTS: 2014 AND 2020 (WEIGHTED)



1.3 RECOMMENDATIONS

Based on the findings from this study, we make the following recommendations:

- » PAs and CPUC policy makers should consider using a benefit-cost ratio of 0.8 as a threshold for the STRC benefit-cost ratios and a ceiling of 1.2 for the PCT benefit-cost ratio when considering technology eligibility and incentives in the SGIP instead of a ratio of 1.0.



- » The cost effectiveness results point to a class of technologies that should be considered for incentives. Incentives provided to SGIP technologies that have 2014 PCT ratios below 1.2 and 2020 STRC ratios equal to or greater than 0.8 provide value to both participants and society. SGIP technologies that meet these criteria include:
 - > Both the 2.5 MW and 7 MW gas turbines fueled by directed biogas or natural gas.
 - > The 500 kW IC engines regardless if fueled by natural gas, directed biogas, or onsite biogas; and the 1.5 MW IC engines fueled by natural gas or directed biogas
 - > The commercial 30 kW stand-alone electric storage technology
 - > The 1.5 MW wind technology.
- » While the model shows onsite biogas technologies as having PCT results above 1.2 without incentives, these technologies have inherent market risks that are difficult to monetize and are not taken into account in the model. Because these technologies also demonstrate high STRC ratios in 2020, they should be considered for incentive payment to help move the market for these technologies and capture the high societal relative benefits.
- » IC engines sized at 1,500 kW and gas turbines sized at 2,500 kW fueled by onsite biogas have 2014 PCT estimates slightly higher than 1.2 with 2020 estimates of STRC that exceed 0.8. Similarly, stand-alone electric storage sized at 5 MW has a 2014 PCT ratio well below 1.2 but a 2020 STRC ratio just barely below 0.8. Given the inherent uncertainty in the value of benefit and cost inputs and forecasts, these technologies should be considered for incentive payment in the SGIP.
- » The MIRR analysis shows that the average MIRR for SGIP technologies without incentives is 10%. In comparison, the average MIRR for SGIP technologies receiving incentives expected at 2014 levels is 12%. Consequently a MIRR target of 12% may provide a good target for setting SGIP incentive levels as this represents the average MIRR value associated with 2014 incentive levels. Ultimately, setting appropriate incentive levels is a policy decision connected to transforming the distributed generation and storage markets.

2 INTRODUCTION AND OBJECTIVES

The purpose of this report is to provide an updated analysis of the cost effectiveness of selected distributed generation and storage technologies being deployed under California's Self-Generation Incentive Program (SGIP). This 2015 SGIP Cost Effectiveness Study updates a 2011 study, which provided a cost effectiveness framework and model to assist in evaluating the eligibility of distributed generation (DG) technologies to participate in the SGIP.¹ The 2015 Study provides updated capital costs, operating and maintenance costs, and projected future costs based on learning curves.² The study also examines an expanded list of SGIP technologies and reflects changes in electricity and gas rates, avoided costs, and newly adopted energy policies. The study is accompanied by an updated SGIP cost effectiveness model entitled 2014 SGIPce.³ The 2015 Study is complemented by a SGIP Market Transformation Study that examines the role of the SGIP in market transformation of California's distributed generation and storage markets.⁴

2.1 CALIFORNIA'S SELF-GENERATION INCENTIVE PROGRAM

California's SGIP provides support to certain distributed generation and storage technologies located on the customer side of the electricity meter. Funded by California ratepayers, the SGIP is managed by Program Administrators (PAs) representing California's major investor owned utilities (IOUs).⁵ The California Public Utilities Commission (CPUC) provides program oversight.

Incentives are provided under the SGIP to participating customers to help offset the cost of buying and installing DER technologies. Technologies currently eligible under the SGIP include wind turbines, fuel cells, gas turbines, microturbines, internal combustion (IC) engines,⁶ waste heat to power systems,⁷

¹ CPUC, *Cost effectiveness of Distributed Generation Technologies: Final Report*, prepared by Itron, February 9, 2011. Copies of the report are available at the CPUC website: http://www.cpuc.ca.gov/NR/rdonlyres/2EB97E1C-348C-4CC4-A3A5-D417B4DDD58F/0/SGIP_CE_Report_Final.pdf

² Learning curves represent an established method for forecasting future performance or costs of technologies. Learning curves fit empirical performance or cost data into trends using power equations. Learning curves are described in more detail in Section 4. Learning curves for each technology are developed and described in Appendix A.

³ We refer to the model as 2014 SGIPce since the starting year for the cost effectiveness runs began in 2014 and go through 2034.

⁴ The SGIP Market Transformation Study is intended to examine the effectiveness of the SGIP on transforming distributed generation and storage technologies since the program's inception. Results from the study will be completed in 2015.

⁵ The PAs are Pacific Gas & Electric (PG&E), Southern California Edison (SCE), Southern California Gas Company (SCG) and the Center for Sustainable Energy (CSE), which represents San Diego Gas & Electric (SDG&E).

⁶ Fuel cells, microturbines, internal combustion engines, and gas turbines can be operated in either electric-only mode or in a combined heat and power configuration.



advanced energy storage technologies, and pressure reduction turbines.⁸ By the end of 2014, the SGIP had provided over \$530 million in incentives to more than 769 projects representing more than 354 MW of rebated generating capacity.⁹

Originally conceived in 2001 to address rolling blackouts occurring across California, SGIP projects have helped meet peak electricity demand and energy needs of utility customers directly at the demand source.¹⁰ As California's energy landscape changed over time, the goals and objectives of the SGIP evolved to respond to the new needs and challenges. The SGIP's goals now include lowering greenhouse gas (GHG) emissions, reducing customer electricity purchases, improving electric system reliability, and supporting market transformation of DER.¹¹

2.2 COST EFFECTIVENESS ANALYSES OF SGIP TECHNOLOGIES

Increased cost effectiveness is one of the primary drivers of market growth and market transformation of distributed generation and storage technologies. For example, the dramatic growth in solar photovoltaic (PV) technologies over the last decade is largely attributed to significant reductions in module costs with a commensurate improvement in the cost effectiveness of PV. Due to these cost reductions, PV systems are able to produce electricity at prices competitive to the conventional grid in an increasing number of locations worldwide.

For a number of distributed generation and storage technologies, advances in manufacturing processes are reducing equipment costs while technology advances are improving performance and increased market deployment are reducing installation costs. A key question is the extent to which cost reductions and improved performance will change the role of distributed generation and storage technologies in the evolving electricity system.

⁷ Waste heat to power is the process of capturing heat discarded by an existing industrial process and using that heat to generate power. Waste heat to power technologies can include steam turbines, Organic Rankine Cycle (ORC) and the Kalina Cycle. Up through 2014, the only waste heat to power technology active within the SGIP has been ORC. Consequently, for this study, only ORC systems are treated as waste heat to power technologies.

⁸ Solar photovoltaic (PV) technologies were originally eligible under the SGIP. However, with emergence of the California Solar Initiative (CSI) and in accordance with Assembly Bill (AB) 2778 (Lieber, September 2006), PV technologies were removed from the SGIP. Instead, incentives for PV technologies are provided under the CSI.

⁹ Excluding incentives paid to PV projects before 2007.

¹⁰ The SGIP was established in response to AB 970, which required the CPUC to initiate certain load control and distributed generation program activities. The CPUC issued Decision 01-03-073 (D.01-03-073) on March 27, 2001 outlining provisions of a distributed generation program, which became the SGIP.

¹¹ In decision D.11-09-015 ("Decision Modifying the Self-Generation Incentive Program and Implementing Senate Bill 412," September 8, 2011), the CPUC established these goals as the "Statement of Purpose" for the SGIP.



Objectives of this Study

Energy policy planners must make decisions about investing in energy resources. Planners face a wide variety of energy resources, each with different costs and each providing multiple benefits. In addition, the relationship between who pays and who benefits from investments in energy resources may not turn out as expected. For example, investment in distributed generation and storage technologies may provide high benefits to utility customers who bought and installed the technology but may result in increased transmission and distribution costs to other utility customers. Finding a way to balance investments against benefits is complex and requires a clear and consistent framework.

Cost effectiveness analyses can provide a clear and consistent framework for comparing the value of competing distributed generation and storage technologies against one another and against conventional grid resources. Cost effectiveness analyses explicitly identify the costs of resources and the associated benefits resulting from their use. Standard cost tests allow costs and benefits to be clearly assigned to different parties so it is clear which parties are paying and which parties are benefiting from use of the energy resources. Learning curves, which provide empirically-based trajectories of technology costs, can be incorporated into the analyses to identify how technological advancements may influence cost effectiveness of energy resources.

This 2015 SGIP Cost Effectiveness Study provides valuable information relative to the following questions:

- » Who pays for the resource being deployed and who benefits?
- » What are the primary components of reduced costs or increased benefits?
- » Are SGIP-related technology costs expected to drop or increase over time and to what extent?
- » How will changes in energy market conditions or policies affect the cost effectiveness of SGIP technologies?
- » Can the level of incentives provided to one SGIP technology impact the economic viability of other SGIP technologies and does that overly affect market competition?

Changes from the 2011 Cost Effectiveness Study

This 2015 SGIP Cost Effectiveness Study has several important changes from the earlier 2011 Study. Capital and operating costs for all SGIP evaluated technologies have been updated. To develop the learning curves used in forecasting future SGIP technology costs, the 2011 Study used cost data starting in 2005 while the current study employs cost data starting in 2010. The updated cost data also allowed updated learning curves for each of the evaluated SGIP technologies. Updated costs and learning curves are based on literature as well as interviews with equipment manufacturers, project developers, and personnel operating distributed generation and storage systems at customer sites.



This study also reflects an expanded set of technologies.¹² SGIP technologies added for evaluation since the 2011 Study are pressure reduction turbines, flow batteries, and 500 kW fuel cell technologies with waste heat recovery. Utility-scale aeroderivative combustion turbines (for peaking purposes) and combined cycle gas turbines have been added to the study to allow comparison between customer-sited SGIP technologies and utility-scale costs.¹³ As indicated in Table 2-1, a total of 15 different SGIP technologies are examined in this 2015 Study.¹⁴

TABLE 2-1: COMPARISON OF TECHNOLOGIES EVALUTED IN 2011 AND 2015 STUDIES

Technology	2011 Study Nominal Size (kW)	2015 Study Nominal Size (kW)	Fuels	Configurations
Small Fuel Cells - CHP	Not treated	500	NG, OSB, DBG	3
Large Fuel Cells - CHP	1200	1,200	NG, OSB, DBG	3
Fuel Cells Electric Only	1200	500	NG, OSB, DBG	3
Small Gas Turbine	2000	2,500	NG, OSB, DBG	3
Large Gas Turbine	2000 to 5000	7,000	NG, OSB, DBG	3
Small IC Engine	500	500	NG, OSB, DBG	3
Large IC Engine	1500	1,500	NG, OSB, DBG	3
Microturbine	200	200	NG, OSB, DBG	3
Organic Rankine Cycle	500	500	Waste heat	1
Small Wind	10	50	Wind	1
Large Wind	1000	1,500	Wind	1
Residential Fuel Cells	5	Not treated	NA	Not treated
Residential Storage	Not treated	5	NA	1
Medium Commercial Storage	25	30	NA	1
Large Commercial Storage	1000	5,000	NA	1
Pressure Reduction Turbine	Not treated	500	In-conduit water flow	1
Utility-scale Combustion Turbine	Not treated	100,000	NG	Not treated
Utility-scale Combined Cycle System	Not treated	500,000	NG	Not treated
Totals:				31

Note: A full list of abbreviations can be found in the glossary at the front of the report.

In addition to technologies, the study considers different fuels used with the technologies. For example, fuel cells, microturbines, IC engines, and gas turbines can use natural gas, directed biogas or onsite

¹² Descriptions of each examined technology are contained in Appendix A.

¹³ Residential CHP fuel cells at the 5 kW size range are not treated in the 2014 study due to lack of market presence of these size systems.

¹⁴ Utility-scale combustion turbines and combined cycle systems are not contained in the SGIPce model but are included in the study for comparison to DER systems.



biogas as fuel sources.¹⁵ Taking into account fuel type, the study looks at 31 different configurations of SGIP technologies.

As shown in Table 2-1, eight of the fifteen SGIP technologies use multiple fuel types. The multiple fuel analysis enables consideration of the impact of the fuel type in association with the technology type on cost effectiveness. In addition, seven of the multiple fuel SGIP technologies can operate as combined heat and power (CHP) systems when fueled by natural gas. Because CHP systems recover waste heat that can be used on meet onsite thermal energy needs, analysis of these technologies as CHP systems provides insights into the cost effective aspects of CHP technologies.

Where applicable, the 2015 Study includes updated electricity and natural gas rates, including changes in non-bypassable charges.¹⁶

A number of changes in energy policies and regulations have occurred since the 2011 Cost Effectiveness Study. The changes reflected in this 2015 Study include targeted growth of energy storage in accordance with AB 2514, new climate change policies, and extension of the SGIP under SB 861. Changes in tax treatment and financing approaches were updated to better reflect developments in distributed generation and storage markets.

This 2015 SGIP Cost Effectiveness Study complements the previously mentioned ongoing study on market transformation of SGIP technologies. Components of the cost effectiveness analysis, particularly the updated costs, benefits and learning curves, are integral to the SGIP Market Transformation Study.

2.3 SCOPE

Primary Focus on SGIP Technologies

This study examines the cost effectiveness of SGIP technologies located on the customer side of the meter. While 15 different SGIP technologies are examined in this study, it is not a comprehensive treatment of all distributed generation or storage technologies. For example, the study does not examine the cost effectiveness of solar PV technologies, which are analyzed in a separate cost effectiveness study conducted for the CPUC.¹⁷

¹⁵ Biogas and onsite biogas are renewable fuels obtained from landfills, waste water treatment plants and dairies.

¹⁶ Non-bypassable charges are also referred to as departing load charges.

¹⁷ Energy and Environmental Economics, Inc., *California Solar Initiative Cost Effectiveness Evaluation*, prepared for the CPUC, April 2011. Available from https://www.ethree.com/documents/CSI/CSI%20Report_Complete_E3_Final.pdf



Cost Test Perspectives

The evaluation of SGIP technology cost effectiveness follows a cost-benefit methodology adopted in August 2009 by the CPUC for evaluating distributed generation (DG).¹⁸ Cost effectiveness is typically examined from four perspectives: all utility customers, including participants and non-participants (Total Resource Cost (TRC)), society (Societal Total Resource Cost (STRC)), participants (PCT), and Program Administrators (PAC). These perspectives are based on cost tests originally developed for evaluating cost effectiveness of energy efficiency technologies, as outlined in the CPUC's Standard Practice Manual.¹⁹ Note that this 2015 Study is not a full cost of service evaluation. A full cost of service evaluation for SGIP technologies would examine the total amount of costs utility customers participating in the SGIP pay relative to other customer groups, based on how participating customers impose costs on the utility. Lastly, the study does not examine cost effectiveness from the perspective of non-participating customers.²⁰ As such, it does not take into account the impact of the SGIP on non-participating customer energy bills.

Twenty-year Timeframe (2014–2034)

Cost effectiveness of SGIP technologies are examined over a 20-year timeframe. Within the model, the technology start date represents the year that generation of technology is deployed. For example, a technology deployed in 2014 will be associated with technology capital and operating and maintenance costs of the 2014 generation. In addition, the 2014 technology costs will be matched by the corresponding 2014 electricity and gas prices, interest rates, etc. Similarly, an SGIP technology deployed in 2017 will be associated with technology capital and operating and maintenance costs of the 2017 generation. The start date represents the beginning of the 20-year timeframe under which that generation of technology is examined. The model then evaluates lifecycle costs and benefits of SGIP technologies over the corresponding 20-year economic life. The SGIPce model is set up to provide four snap-shots of cost effectiveness, presenting cost effectiveness information for SGIP technologies installed in 2014, 2017, 2020, and 2024. Within the report, summary results are presented for 2014 and 2020, while technology-specific results are often provided for in the four-year snap-shots.

2.4 REPORT ORGANIZATION

This report is organized into six sections and five appendices as described below:

¹⁸ CPUC, Decision 09-08-026, August 2009, pg. 4 from http://docs.cpuc.ca.gov/word_pdf/FINAL_DECISION/105926.pdf

¹⁹ CPUC, *California Standard Practice Manual: Economic Analysis of Demand-Side Programs and Projects*, 2001, from http://www.cpuc.ca.gov/NR/rdonlyres/004ABF9D-027C-4BE1-9AE1-CE56ADF8DADC/0/CPUC_STANDARD_PRACTICE_MANUAL.pdf

²⁰ The cost test for non-participating customers is known as the Ratepayer Impact Measure (RIM) test. The CPUC specifically excludes use of the RIM test in evaluating the cost effectiveness of DG technologies in the August 2009 decision (see D.09-08-026, pg. 25).



- » **Section 1** provides an executive summary of the key findings and recommendations.
- » **Section 2** describes the purpose, scope, and organization of the report.
- » **Section 3** provides background on SGIP technologies deployed in California; changes in the SGIP technologies, markets and policies; and the role of SGIP in supporting distributed generation and storage market development.
- » **Section 4** explains the cost effectiveness evaluation approach and methodology.
- » **Section 5** lays out the structure, functioning, and output of the cost effectiveness model developed under this study: 2014 SGIPce.
- » **Section 6** presents the cost effectiveness evaluation results.
- » **Appendix A** provides details on the different SGIP technologies examined in the study.
- » **Appendix B** provides details on the utility-scale generation technologies examined in the study.
- » **Appendix C** contains detailed charts and tables associated with individual SGIP technology cost-test and modified IRR (MIRR) results.
- » **Appendix D** is the User Guide for the 2014 SGIPce Model.
- » **Appendix E** provides details on the different equations and approaches used for the different cost effectiveness tests.

3 BACKGROUND AND STATUS

California is often recognized as a leader in supporting the growth of energy efficiency, demand response, renewable energy and distributed generation measures and technologies. Since the 1980s, growth in these distributed energy resources (DER) increased in California due to favorable market conditions, more advantageous interconnection policies, net energy metering regulations, utility procurement practices, and programs focused on advancing the integration of clean DER into California's grid.¹ The economics and cost effectiveness of DER technologies will also dictate the extent to which DER technologies play a role in California's future energy mix. However, cost effectiveness of DER technologies is influenced by policies, the DER market, and the energy landscape. By providing incentives to specific types of DER technologies², the SGIP provides support to DER development and market transformation in California. To better understand the relationship between the cost effectiveness of DER technologies supported by the SGIP and the surrounding market environment, it is important to look back at the development of SGIP supported technologies in California and how that market may be changing.

This section provides information on the background of SGIP-supported DER development in California, including policies and programs that were instrumental in their market deployment. This history identifies changes in cost effectiveness of SGIP-supported DER technologies and the influence of programs and policies on their technology costs. We discuss the status of SGIP-supported DER technologies in California at the end of 2014 and finish the section with a discussion of changes occurring in California's energy markets that could influence further growth of SGIP-supported DER technologies.

3.1 SGIP-SUPPORTED DER IN CALIFORNIA

In discussing SGIP-supported DER technologies, we need to first define what we mean by DER. The CPUC has defined distributed generation (DG) as "small scale electric generating technologies installed at, or in close proximity to, the end-user's location."³ The California Public Utilities Code further defines DER as "distributed renewable generation resources, energy efficiency, energy storage, electric vehicles, and demand response technologies."⁴

¹ For a history of DER in California, see *Impacts of Distributed Generation: Final Report*, prepared by Itron for the CPUC, January 2010 and *Biennial Report on Impacts of Distributed Generation*, prepared by Black & Veatch, May 2013.

² In particular, the SGIP provides support to distributed generation and storage technologies.

³ CPUC Decision (D.) 99-10-065, 1999.

⁴ Public Utilities Code, Division 1, Part 1, Chapter 4, Article 3, from http://leginfo.legislature.ca.gov/faces/codes_displaySection.xhtml?lawCode=PUC§ionNum=769



In light of these definitions, DER could consist of a wide variety of technologies. However, this study focuses only in technologies that are eligible under the SGIP as of 2014. For the purposes of this study, SGIP-supported DER consists of renewable and certain no-renewable (e.g., natural gas fueled) distributed generation; and advanced energy storage technologies located on the customer side of the meter.⁵ Note that SGIP-supported distributed generation and storage systems tend to be sized to displace electricity demand for the end user, but can include a limited export of electricity to the grid.

Specific SGIP Technologies and Configurations Evaluated

SGIP technologies evaluated in this study are limited to technologies that are eligible under the SGIP as of the end of calendar year 2014. These technologies include generation systems fueled by renewable and non-renewable energy sources as well as storage technologies.⁶ Renewable resources include wind, waste heat, in-conduit water flow, and “onsite” as well as “directed” biogas.⁷ Specific technologies evaluated include IC engines, gas turbines, microturbines, fuel cells, wind energy systems, waste heat to power systems, pressure reduction turbines, and stand-alone battery energy storage systems.⁸

SGIP technologies are designed in a wide variety of sizes and operation of the technologies can vary significantly from one site to the next. We did not attempt to develop a statistically-based sample of system sizes. Instead, representative generation profiles are based on hundreds of generation profiles of SGIP technologies in different configurations collected over 12 years of SGIP operation. The nominal capacities and fuel types selected for evaluation are ones we consider to be representative of the systems operating in the SGIP. While differences in capacity and operation would provide different cost effectiveness results, many of these changes could produce only slightly different results. Based on different fuel types, technologies and nominal sizes, the evaluated technologies include 31 different configurations of SGIP technologies, as shown in Table 3-1.⁹

⁵ While the CPUC definition for DER specifically limits distributed generation to renewable resources, the SGIP allows both renewable as well as natural gas fueled distributed generation technologies.

⁶ Solar generation technologies are not examined in this study as cost effectiveness of solar technologies is examined in the CPUC report *California Net Energy Metering Ratepayer Impacts Evaluation*, October 28, 2013.

⁷ Biogas sources can be “onsite” biogas or “directed” biogas. Onsite biogas projects use biogas developed directly at the customer site to power the generator. Onsite biogas projects typically use biogas derived from anaerobic digesters used at dairies, wastewater treatment plants, or food processing facilities to convert wastes from these facilities to biogas. In contrast, directed biogas projects use biogas fuel that is produced at a location other than the project site. The procured biogas is processed, cleaned-up, and injected into a natural gas pipeline for distribution. Although the purchased biogas is not likely to be delivered and used by the directed biogas project, the directed biogas is notionally delivered and the project is credited with the overall use of biogas resources.

⁸ As PV was not evaluated in this study, we limited evaluation of battery energy storage systems to stand-alone systems.

⁹ Utility-scale combustion turbines and combined cycle systems are examined in the study to allow cost comparison to DER technologies but are not contained in the SGIPce model.



TABLE 3-1: EVALUATED SGIP TECHNOLOGIES, FUELS, AND NOMINAL CAPACITIES

Technology	Fuels*	2015 Study Nominal Size (kW)	Configurations
Small Fuel Cells - CHP	NG, OSB, DBG	500	3
Large Fuel Cells - CHP	NG, OSB, DBG	1,200	3
Fuel Cells - Electric Only	NG, OSB, DBG	500	3
Small Gas Turbine	NG, OSB, DBG	2,500	3
Large Gas Turbine	NG, OSB, DBG	7,000	3
Small IC Engine	NG, OSB, DBG	500	3
Large IC Engine	NG, OSB, DBG	1,500	3
Microturbine	NG, OSB, DBG	200	3
Organic Rankine Cycle	Waste Heat	500	1
Small Wind	Wind	50	1
Large Wind	Wind	1,500	1
Residential Storage	NA	5	1
Small Commercial Storage	NA	30	1
Large Storage	NA	5,000	1
Pressure Reduction Turbine	In-conduit water flow	400	1
Totals			31

* NG is natural gas, OSB is onsite biogas, and DBG is directed biogas

Current Status of SGIP-Supported Technologies in California

Technologies represented by the SGIP make up a small but growing amount of customer-based power resources in California. Table 3-2 provides an overview of different types of customer-based distributed generation and storage resources and their capacities in California as of December 31, 2014.¹⁰ At the end of 2014, there were over 215,000 distributed generation and storage projects, responsible for approximately 2,500 MW of customer-based generation.¹¹ Solar PV currently makes up the largest number and capacity of this distributed generation resource. However, the number and capacity of advanced energy storage (AES) systems is expected to increase in the next several years. An October 2013 ruling by the CPUC adopted an energy storage procurement framework and energy storage target of 1,325 MW for the three major California electricity IOUs by 2020.¹² The customer portion of the storage targets equals 200 MW.

¹⁰ While solar PV is not evaluated in this cost-effectiveness study, the capacity of solar PV is presented to help provide the context of the amount of distributed generation resources available in California.

¹¹ The SGIP has continued to grow. However, we use December 31, 2014 as a starting baseline in this study as it is also the starting baseline for the cost effectiveness model.

¹² Decision 13-10-040 October 17, 2013.



TABLE 3-2: DER PROJECTS AND CAPACITY IN CALIFORNIA AT 12/31/2014

Technology	PG&E		SCE		SDG&E		POU		Statewide	
	No.	MW	No.	MW	No.	MW	No.	MW	No.	MW
Solar PV¹³	84,413	950.7	78,816	765.3	23,850	206.1	27,582	228.3	214,661	2,150.3
Wind	12	8.6	9	15.1	1	1.0	0	0.0	22	24.7
Renewable	66	25.8	42	25.7	16	8.5	8	4.9	132	65.0
- Gas Turbines	0	0.0	0	0.0	0	0.0	0	0.0	0	0.0
- Microturbines	15	2.1	6	2.5	4	0.8	0	0.0	25	5.4
- IC engines	17	9.4	10	6.9	2	0.7	0	0.0	29	16.9
- Fuel cells	34	14.4	26	16.3	10	7.1	8	4.9	78	42.7
Non Renewable	255	102.8	206	109.5	54	28.6	37	18.7	552	259.6
- Gas Turbines	3	4.0	4	17.0	2	9.1	0	0.0	9	30.1
- Microturbines	49	10.8	52	8.9	13	1.1	9	2.2	123	23.0
- IC engines	104	57.4	100	70.5	21	12.1	7	3.0	232	143.1
- Fuel cells	99	30.6	50	13.1	18	6.2	21	13.4	188	63.4
AES	30	2.9	4	1.1	2	0.0	26	0.1	62	4.2
WHP	0	0.0	0	0.0	0	0.0	0	0.0	0	0.0
PRT	0	0.0	0	0.0	1	0.5	0	0.0	1	0.5
Totals:	84,776	1,091	79,077	917	23,924	245	27,653	252	215,430	2,504

3.2 THE CHANGING FACE OF SGIP TECHNOLOGIES

California’s market for distributed generation and storage technologies has evolved since 2010. The technologies have improved, new energy policies have emerged, and there is a new set of market players.

Technology Advancements

AES is one of the fastest growing DER technologies in California’s electricity grid. AES project applications are located at residential, commercial, and industrial host customer sites in size ranges from 5 kW to several megawatts. SGIP AES projects are expected to deliver benefits through numerous value streams including increased customer reliability, reduced customer demand, reduced peak energy consumption (arbitrage), and balancing of intermittent renewable resources such as solar PV and wind. The importance of AES in the SGIP may change dramatically in the coming years. For example, there

¹³ PV Counts and capacities are based on systems that received a state incentive and were installed through December 31, 2014. These include the CSI, New Solar Homes Partnership (NSHP), SGIP, Emerging Renewables Program (ERP), and publicly owned utility (POU)-reported installations. These totals do not include systems that did not receive an incentive. The solar PV estimates are derived from California Solar Statistics at <https://www.californiasolarstatistics.ca.gov/>



were 62 AES projects that had received incentives by the end of 2014; as of May 2015, there were almost 1,200 AES projects that had applied for SGIP incentives.

Distributed Generation and Storage Policies

Numerous policies and decisions have influenced the cost effectiveness of SGIP technologies over the past five years. On June 20, 2014, the Governor signed SB 861¹⁴ which, among other things, extends the CPUC's ability to authorize the IOUs to administer the SGIP through January 1, 2021, and to collect an annual budget that does not exceed the 2008 budget (\$83 million per year) through December 31, 2019. An extension of the SGIP means continued support for distributed generation and storage technologies, with commensurate opportunities to lower distributed generation and storage technology costs and improve performance.

Customer-sited storage is expected to increase. Pursuant to AB 2514, in October 2013, the CPUC adopted an energy storage procurement framework and established energy storage targets for PG&E, SCE, and SDG&E.¹⁵ A total of 1,325 MW in storage capacity is to be procured by 2020, with installations to be completed no later than 2024. The decision further establishes a target for community choice aggregators and electric service providers to procure energy storage equal to 1 percent of their annual 2020 peak load by 2020 with installations completed no later than 2024. An important component of the targets was the specific allocation to customer-sited, behind-the-meter storage with the intent to affect areas such as bill management, permanent load shifting, maintaining power quality, and electric vehicle charging. In total, 200 MW of behind-the-meter storage must be collectively procured by the electric IOUs by 2020.

Policies to encourage growth in distributed generation and storage technologies are being implemented. In August of 2014, the CPUC instituted R. 14-08-013 to establish policies, procedures, and rules to guide California IOUs in developing Distribution Resources Plan (DRP) Proposals, which they are required by PU Code Section 769 to file by July 1, 2015. This rulemaking will also evaluate the IOUs' existing and future electric distribution infrastructure and planning procedures with respect to incorporating distributed generation and storage technologies into the planning and operation of their electric distribution systems.

¹⁴ Public resources trailer bill, June 20, 2014.
http://leginfo.legislature.ca.gov/faces/billNavClient.xhtml?bill_id=201320140SB861

¹⁵ "Decision Adopting Energy Storage Procurement Framework and Design Program," Decision 13-10-040, October 17, 2013. Copies of the decision are available at:
<http://docs.cpuc.ca.gov/PublishedDocs/Published/G000/M079/K533/79533378.PDF>



A New Distributed Generation and Storage Market

Since 2010, the market landscape for distributed generation and storage has changed dramatically. New market players are planning significant investments into the energy storage market.¹⁶ In the SGIP, there has been significant growth in fuel cells and wind turbine projects. The number of IC engine and microturbine applications has decreased drastically. Looking beyond 2014, significant growth is expected in the number of AES projects that apply for SGIP incentives. As of May 2015, there were almost 1,200 AES projects that had applied for SGIP incentives. Most of these projects are smaller than 30 kW but seven projects are sized larger than 1 MW.

Changes in Electric Rule 21 will enable remote communication capabilities in smart inverters. These enhancements may also allow electric utilities to participate in the dispatch of inverter-based distributed generation and storage technologies such as fuel cells and AES. As distributed generation and storage dispatch abilities increase, so does the ability of these technologies to provide increased value to utilities as well as utility customers in helping to meet peak demand.

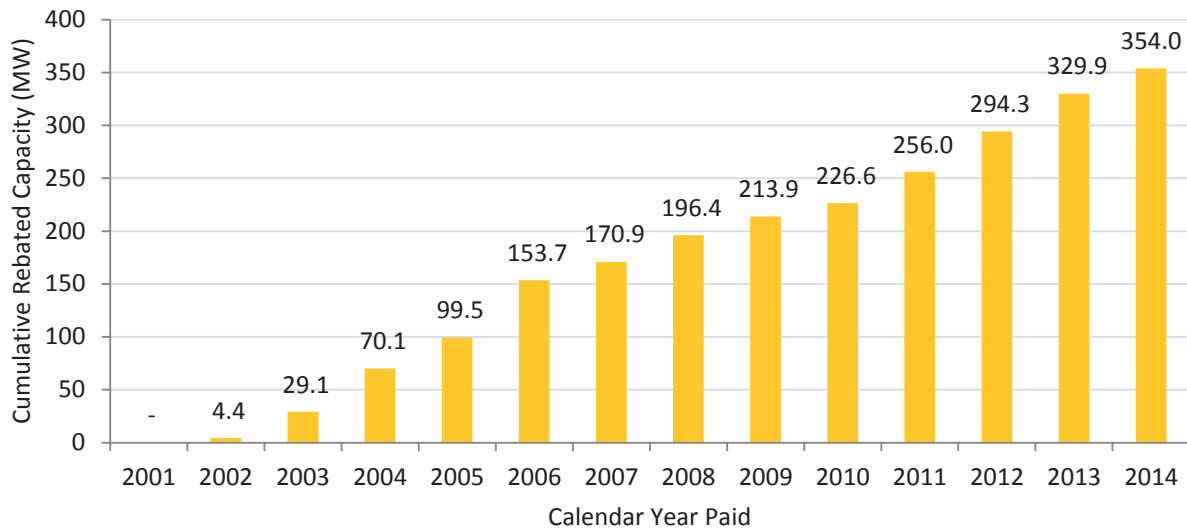
3.3 SGIP'S ROLE IN DISTRIBUTED GENERATION AND STORAGE DEVELOPMENT

One of the primary goals of the SGIP is to support the development and adoption of distributed generation and storage technologies in the marketplace. The cumulative growth in SGIP capacity since its inception in 2001 is shown in Figure 3-1. Since the program's inception in 2001, there has been a steady increase in distributed generation and storage technologies supported by the SGIP. By the end of 2014, the SGIP provided incentives to 769 projects representing over 354 MW of rebated capacity.

¹⁶ For example, see Fortune magazine, "Elon Musk: Demand for Tesla's home battery is 'crazy off the hook'," From <http://fortune.com/2015/05/06/elon-musk-tesla-home-battery/>



FIGURE 3-1: CUMULATIVE REBATED CAPACITY BY CALENDAR YEAR



Pending projects in the SGIP also indicate likely continued support of distributed generation and storage technologies and associated growth in their future capacity. Projects that were not paid on or before December 31, 2014, and have not had their applications cancelled, rejected, or withdrawn are considered to be in the SGIP queue. As of May 2015, there were almost 1,500 projects representing 286 MW of capacity in the SGIP queue. These projects represent the potential growth in distributed generation and storage technologies. While there are a variety of technologies in the SGIP queue, most of the potential capacity is made up primarily of AES and electric-only fuel cell projects.

4 COST EFFECTIVENESS APPROACH AND METHODOLOGY

As previously stated, the purpose of this 2015 SGIP Cost Effectiveness Study is to evaluate the cost effectiveness of distributed generation and storage technologies being installed under California’s SGIP. Cost effectiveness analysis provides policy makers with needed information on costs and benefits of distributed generation and storage technologies. It is critical in helping determine whether particular efforts in an incentive program should be continued in their current form or be altered in some way to achieve expected economic benefits. More broadly, an SGIP cost effectiveness analysis allows insights into the effects of rate structures, incentive levels and other policies on costs and benefits of distributed generation and storage technologies being implemented under the SGIP. This section describes the approach for evaluating the cost effectiveness of SGIP technologies, specific cost tests used, how learning curves are incorporated into the evaluation, and critical inputs and assumptions. At the technology level, results are viewed at four distinct years (2014, 2017, 2020 and 2024) to help identify how changes in technology costs, incentive levels, or the market are influencing SGIP cost effectiveness results. Summary results are shown at 2014 and 2020 to identify major changes between the starting point of this analysis and the expected end date of the program.

4.1 OVERVIEW OF SGIP COST EFFECTIVENESS APPROACH

In 2009, the CPUC adopted an evaluation framework and methodology for assessing cost effectiveness of DG technologies.¹ The DG cost effectiveness methodology is derived from the Standard Practice Manual (SPM) first published in the 1980s and used for several decades in evaluating energy efficiency technologies and programs.² The 2009 CPUC decision on DG cost effectiveness provides specific guidance in six areas:

- » Cost tests to be used in the evaluation
- » Costs and benefits to be addressed in the evaluation by each test and the associated input variables
- » Use of avoided costs already adopted by the CPUC for evaluating energy efficiency programs
- » Treatment of transmission and distribution (T&D) investment deferrals
- » Inclusion of environmental benefits used in energy efficiency evaluations, whether required by regulation or compliance with state or federal laws
- » Use of qualitative analysis of market transformation effects

1 CPUC, “Decision Adopting Cost-Benefit Methodology for Distributed Generation,” Decision D.09-08-026, August 20, 2009

2 We reference the 2001 version of the Standard Practice Manual; CPUC, *California Standard Practice Manual: Economic Analysis of Demand-Side Programs and Projects*, October 2001: from http://www.cpuc.ca.gov/NR/rdonlyres/004ABF9D-027C-4BE1-9AE1-CE56ADF8DADC/0/CPUC_STANDARD_PRACTICE_MANUAL.pdf



We followed the guidance provided by the 2009 CPUC decision in developing the approach for this 2015 Study.³

Behind-the-meter storage has many of the same attributes as distributed power generation technologies. Consequently, we use the 2009 CPUC-approved DG cost effectiveness framework and methodology in evaluating cost effectiveness of both distributed generation and storage technologies in the SGIP study.

We use a levelized cost model in assessing cost effectiveness of SGIP technologies. By “levelized,” we mean we treat the costs and benefits of the SGIP technologies over their expected lifetimes. A number of factors can change during that time, including additional capital costs associated with repair or maintenance of equipment, the cost of labor, interest rates on money, taxes, and policies. The cost effectiveness evaluation must take into account the way in which these factors change over time so technologies can be compared accurately. In Section 4-4 we describe how we take these factors into account and state any critical assumptions about evaluation parameters.

Results of the cost effectiveness evaluation can be expressed in a variety of ways. Net present value (NPV) is a primary measure of cost effectiveness that takes into account the time value of money. NPV can be viewed as the difference between the sums of discounted cash inflows (e.g., benefits) and cash outflows (e.g., costs) on a lifecycle basis. It compares the present value of money today to the present value of money in the future based on the discount rate. The discount rate represents the rate of return that can be earned on the investment with a given amount of risk. Each of the cost effectiveness tests represents a particular stakeholder’s point of view, therefore each test should use the discount rate associated with test’s perspective. A commonly used discount rate in commercial investments is the weighted average cost of capital (WACC). The WACC is often used for the PAC and TRC tests. The societal discount rate (typically a discount rate that is lower than the WACC) is used for the STRC to reflect the discounted value of costs and benefits to society over a long time period.

NPV can be thought of as an indicator of the value of the technology as an investment in the SGIP (or in any portfolio of technologies). In general, a positive NPV means the technology represents an “acceptable” investment, whereas a negative NPV means the technology has a lower return than investing the same money in the marketplace. An NPV of zero means the technology represents a neutral investment.

The SPM suggests other measures of cost effectiveness can include discounted payback (in years), benefit-to-cost ratio and levelized cost of energy (\$ per kWh of energy or demand). We use several of these metrics in the evaluation of SGIP technology cost effectiveness.

3 The 2009 CPUC Decision specifically identified use of avoided costs established by Energy and Environmental Economics (E3).



4.2 EVALUATION COST TESTS

In accordance with the adopted CPUC DG cost effectiveness methodology, we evaluate SGIP technologies using four cost tests: the Participant Cost Test (PCT), the Total Resource Cost (TRC) test, the Societal Total Resource Cost (STRC) test, and the Program Administrator Cost (PAC) test.

Participant Cost Test

The PCT compares the costs and benefits to customers participating in a program (e.g., the SGIP) and can be used to determine if the participant will benefit from installing the technology over the technology's expected life. It looks at the value of the program or measure from the perspective of the customer.

Examples of participant costs are any equipment or materials purchased by the customer to participate in the program, including sales tax and installation costs; any ongoing operation and maintenance (O&M) costs; any removal costs (less salvage value); and the value of the customer's time in arranging for the installation of the equipment. Examples of participant benefits include bill savings resulting from reduced energy or demand; incentives received from the program (or other sources associated with the installed technology); federal, state, or local tax credits; and other forms of credits (e.g., renewable or "green" energy credits).

The PCT determines if the benefits associated with the customer's participation in the program outweigh the costs. The test is also useful to program planners in determining if incentives are needed to induce participation and assessing the level of incentive needed to encourage participation. In the case of different fuel sources (e.g., natural gas versus onsite biogas or directed biogas), results from the PCT can help determine the economic attractiveness of fuel switching.

For PAs and policy makers, it would be ideal to understand the reasons why customers do or do not participate in a program when the program is cost effective from the participant's perspective. An inherent weakness of the PCT is that it can fail to accurately capture the more complex motivations behind why customers participate in programs such as the SGIP. In general, customers are motivated to participate for a number of reasons. Some customers participate to obtain an incentive or benefit from program requirements that result in lower energy costs. Other customers are motivated to participate for non-economic reasons. For example, some customers may choose to participate in order to purchase equipment that results in "green" energy at a reduced cost or because they do business with equipment suppliers who have recommended the program. Moreover, for utility customers who participate in the SGIP, there are accrued benefits that are hard to quantify; while very real, these indirect benefits may not be accurately captured in the PCT.

Total Resource Cost Test

The TRC test treats the program as a series of resource options. The value of the test can help to determine if the total costs of energy in the utility service territory will increase or decrease with the



implementation of the program or technology. The test measures the net benefits and costs of a program and/or technology that accrue to society, which is defined as the utility (program administrator) and all of its customers. The TRC test examines the value of the program as another way to achieve certain utility or policy goals.

Costs in the TRC test include program costs paid by both the utility and the participants plus any increases in fuel supply costs in order to operate SGIP technologies in the program. All equipment costs, installation, O&M, cost of removal (less salvage value), and administration costs, no matter who pays for them, are included in this test. The incentive payments are not a cost or a benefit in the TRC.

Examples of benefits included in the TRC test are avoided electricity and fuel supply costs and reductions in transmission, distribution, generation, and capacity costs valued at marginal cost for the periods when there is a load reduction. Additional benefits include tax credits and state and federal tax rebates received due to the installation of SGIP technologies.

Societal Total Resource Cost Test

The STRC test is a variation of the TRC test. The STRC test differs from the TRC test in that it includes the effects of externalities⁴ (e.g., environmental impacts, improved security of the grid, employment, etc.) and uses a different (i.e., societal) discount rate.⁵ The STRC test looks at the cost effectiveness of the projects or program from society's perspective.

Examples of societal costs are costs borne by both the participants and the program, including all equipment costs, installation, O&M, and cost of equipment removal (minus salvage value). Program administration and marketing expenses are included as STRC costs. Costs for increases in fuel supplies to the participants are also considered costs.

Examples of benefits within the STRC test are avoided fuel costs associated with net decreases in energy and demand, reductions in transmission and distribution system costs, and improvements in system reliability or improvements to the environment (e.g., reduced air pollution emissions, reduced GHG, etc.). Tax credits and tax rebates received by the participant are also benefits within the STRC test.

⁴ Externalities can be defined as “a situation in which the private costs or benefits to the producers or purchasers of a good or service differs from the total social costs or benefits entailed in its production and consumption. An externality exists whenever one individual's actions affect the well-being of another individual—whether for the better or for the worse—in ways that need not be paid for according to the existing definition of property rights in the society.” From “A Glossary of Political Economy Terms,” <https://www.auburn.edu/~johnspm/gloss/externality>

⁵ The discount rate used in the STRC is 5% and in the TRC is 7.5%.



Program Administrator Cost Test

The PAC test examines cost-effectiveness from the perspective of the PA or utility. The PAC takes into account the costs incurred by the PA including incentive costs and program marketing and administrative costs.

Examples of costs included in the PAC are expenses incurred by the PA in implementing the program, incentives paid to participating customers, and any increases in fuel costs associated with operating the program. Administrator program expenses include the initial and ongoing costs of operating the program. These costs can include costs for additional utility equipment needed by the utility in operating the program, ongoing utility O&M costs, and costs associated with drop out of program participants.

Among the benefits allocated to the PA are fuel and energy costs avoided from operation of the program, reductions in T&D system costs (including deferral of equipment installation to meet increased demand on the T&D system and reduced operating costs), capacity savings and monetary benefits from standby charges.

Table 4-1 and Table 4-2 summarize the benefits and costs used in the cost effectiveness evaluation in each of the cost tests. Specific values or treatment of costs and benefits are discussed in Section 4-4.

TABLE 4-1: SUMMARY OF BENEFITS ALLOCATED BY COST TESTS

Benefits	PCT	TRC	STRC	PAC
Avoided line losses		✓	✓	✓
Avoided purchase of energy commodity and resource adequacy costs		✓	✓	✓
Avoided T&D costs (T&D Investment Deferrals)		✓	✓	✓
CHP plant-specific benefits	✓	✓	✓	
CHP gas and electric bill savings	✓	✓	✓	
Environmental benefits (CO ₂ , NO _x , and particulate matter emissions)		✓	✓	
Market transformation effects	✓	✓	✓	
Net energy metering (NEM) bill credits	✓			
Rebates/Incentives	✓			
Reduced electricity bills	✓			
Reliability benefits (both system and customer ancillary services/VAR support)	✓	✓	✓	✓
Standby charge exemptions	✓			
Tax credits/depreciation	✓	✓	✓	
Utility interconnection not charged to SGIP customer	✓			



TABLE 4-2: SUMMARY OF COSTS ALLOCATED BY COST TESTS

Costs	PCT	TRC	STRC	PAC
Costs of SGIP system, interconnection, emission controls and offset purchases	✓	✓	✓	
Increased energy and demand costs	✓			
Increased IOU fuel transportation costs for gas-fired SGIP technologies	✓			
NEM costs				✓
Non-bypassable charges (PGC, DWR, nuclear decommissioning)	✓			
Operation maintenance, fuel, ongoing emission offset purchases	✓	✓	✓	
Program administration		✓	✓	✓
Reduced revenue from standby charge exemptions				✓
Reduced transmission, distribution, and non-fuel generation revenues				✓
Reliability costs (system cost of additional ancillary services/VAR support)		✓	✓	✓
Removal costs (less salvage)	✓	✓	✓	
Utility interconnection		✓	✓	✓
Utility rebates/Incentives (non-NEM)				✓

4.3 USE OF LEARNING CURVES IN ESTIMATING FUTURE TECHNOLOGY COSTS

Anyone who has observed computer or cell phone markets over the past decade can attest to the rapid rate at which technologies can advance in performance and cost. When evaluating cost effectiveness of SGIP technologies over a 20-year timeframe, it is important to be able to predict possible future changes in SGIP technology costs.

Learning curves represent an established method for forecasting future performance or costs of technologies. Learning curves fit empirical performance or cost data into trends using power equations. One of the most famous learning curves is Moore’s Law. Developed in the semiconductor industry, Moore’s Law accurately predicted that “the number of transistors incorporated in a chip will approximately double every 24 months.”⁶

Learning curves are based on the premise of “learning by doing.” As technologies undergo development, manufacturers find ways to refine the production process and reduce equipment costs. Increased production also leads to economies of scale. Market competition encourages further innovation and improvements. As a result, future units will cost less to produce due to improved learning.

6 “Moore’s Law and Intel Innovation,” from <http://www.intel.com/content/www/us/en/history/museum-gordon-moore-law.html>



Mathematically, future prices of a product can be related to its volume of production through a power equation:

$$\text{Price at year } t = P_0 * X^{-E}$$

P_0 is the price at one unit of cumulative production or sales of the product and “X” is the cumulative production or sales through year t divided by the cumulative production as of year zero. “E” represents the “experience” parameter and determines the steepness of the curve. Large values of E indicate a steep curve with a high learning rate (LR). In this manner, learning rate is a metric for estimating the extent to which technology costs are reduced for each doubling of production.

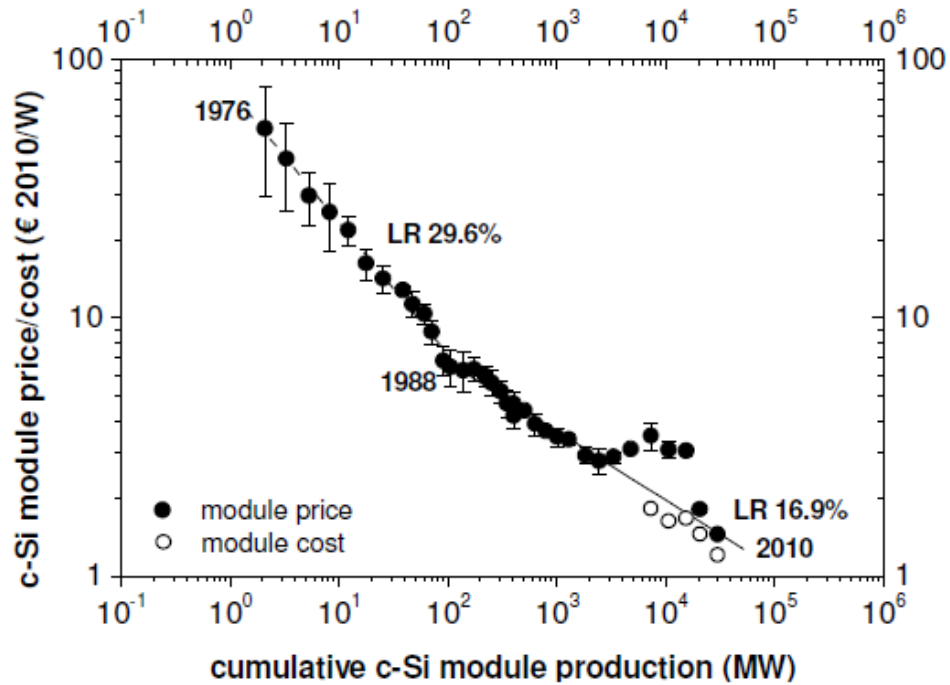
The progress ratio (PR) is another term used when describing learning curves. The PR is defined mathematically in relationship to the learning curve and the experience parameter (E) as follows:

$$\text{LR} = 1 - \text{PR}$$

$$\text{PR} = 2^{-E}$$

A PR of 1 (100%) represents no change in the cost of the system over time, regardless of how many units are manufactured. In essence, there is no “learning by doing.” A PR of 0.8 (or a learning rate of 20%) indicates that, based on projected shipment volumes, the cost of the unit would be reduced by 20% with doubling of the worldwide volumes. PRs apply over the life of the product.

Figure 4-1 shows another famous learning curve: the solar PV learning curve. The PV learning curve relates the cost of PV modules to the volume of module production. In this example, crystalline silicon (c-Si) PV module production and module prices between 1976 and 1988 showed an LR of 29.6%. Similarly, data from 1988 through 2010 showed a reduced LR of 16.9%. Using the analogy of Moore’s Law, the 1998 to 2010 data indicates PV module costs dropped approximately 17% per doubling of the cumulative PV production output.

FIGURE 4-1: PV LEARNING CURVE


Source: Kersten, Friederike, et.al. "PV Learning Curves: Past and Future Drivers of PV Cost Reduction," 26th European Photovoltaic Solar Conference, 2011

We developed learning curves for each of the SGIP technologies evaluated in the study. Volume production data, the associated sales prices, and the resulting learning rates and progress ratios for each evaluated technology are presented in Appendix A.

**TABLE 4-3: PROGRESS RATIOS FOR EVALUATED SGIP TECHNOLOGIES**

Technology	Progress Ratio (%)	Learning Rate (%)
Small Fuel Cells - CHP	85%	15%
Large Fuel Cells - CHP	85%	15%
Fuel Cells - Electric Only	85%	15%
Small Gas Turbine	87%	13%
Large Gas Turbine	94%	6%
Small IC Engine	96%	4%
Large IC Engine	94%	6%
Microturbine	88%	12%
Organic Rankine Cycle	100%	0%
Small Wind	95%	5%
Large Wind	93%	17%
Residential Storage	80%	20%
Non-residential Storage	80%	20%
Large Storage	80%	20%
Pressure Reduction Turbine	100%	0%

4.4 CRITICAL INPUTS AND ASSUMPTIONS

SGIP Technology Operations

Costs and benefits of SGIP technologies are influenced by their operations. Energy storage systems cycle between charging and discharging of storage electricity. Their cost of operation depends on when they charge, the price of the electricity used for charging the system and the efficiency with which they charge and discharge stored energy. Wind systems have no fuel costs but produce electricity intermittently, based on availability of the wind. In contrast, CHP systems typically use natural gas in generators to produce electricity and so bear fuel costs. However, CHP systems also produce energy from recovered waste heat, thereby offsetting onsite boiler fuel purchases.

We characterize SGIP operations by technology type, fuel consumed, nominal rated capacity, typical annual capacity factor, electrical efficiency, overall system efficiency, useful waste heat recovery rate (for CHP systems) and annual degradation.

Fuel Consumed

Fuel consumed by SGIP technologies can either be natural gas or a renewable. Renewable fuel types include wind, onsite biogas, and directed biogas.



Nominal Rated Capacity

SGIP technologies are designed in a wide variety of sizes and operation of the technologies can vary significantly from one site to the next. We did not attempt to develop a statistically-based sample of system sizes. Instead, we have reviewed hundreds of generation profiles of SGIP technologies in different configurations collected over 12 years of SGIP operation. We consider the nominal capacities and fuel types selected for evaluation to be representative of distributed generation and storage systems operating in the SGIP.

Annual Capacity Factor

“Annual capacity factor” refers to the amount of power produced annually by a generator relative to the amount of energy that could be produced from the generator during the year at its rated capacity. For example, a generator rated at 100 kW could theoretically produce 700,800 kWh of electricity during a year at an 80% annual capacity factor.⁷ Since 2011, all SGIP technologies except wind and advanced energy storage are assumed to operate at an 80% annual capacity factor to achieve necessary GHG emission reduction goals and SGIP Handbook guidelines.⁸ However, legacy SGIP projects may operate at less than 80% capacity factor. SGIP projects that follow electrical loads at the customer site, or CHP projects that follow thermal loads, may choose to operate with annual capacity factors less than 80% for financial reasons.

Efficiencies

“Electrical efficiency” refers to the efficacy with which a generator produces power. Electrical efficiency is measured as the amount of electricity generated per amount of fuel or energy consumed by the generator. Electrical efficiencies are based on higher heating value (HHV).⁹ In general, SGIP systems have electrical efficiencies ranging from 30% to 60%, while energy storage systems can have electrical efficiencies as high as 98%. Overall system efficiency for a CHP system is the sum of the electrical efficiency of the generator plus the efficiency with which it produces thermal energy.

Mathematically, electrical efficiency and overall system efficiency are related to the amount of fuel consumed as follows:

⁷ For simplicity, we assume 8,760 hours of operation for this example. Operating at an 80% capacity factor results in 100 kW times 8,760 hours per year times 0.8, resulting in 700,800 kWh per year.

⁸ Wind and advanced energy storage are assumed to operate at 25% and 10% annual capacity factors, respectively. In addition, SGIP technologies that meet the SGIP GHG requirements may have annual capacity factors below the assumed levels.

⁹ HHV refers to the amount of heat released from combustion of fuel when all the products of combustion are brought back to the original pre-combustion temperature, and in particular condensing any vapor produced. Units of HHV are typically Btu/SCF of fuel.

$$\text{Electrical Efficiency} = \text{Electrical Output} / \text{Fuel Consumed}$$

$$\text{System Efficiency} = \frac{\text{Electrical Output} + \text{Useful Waste Heat Recovered}}{\text{Fuel Consumed}}$$

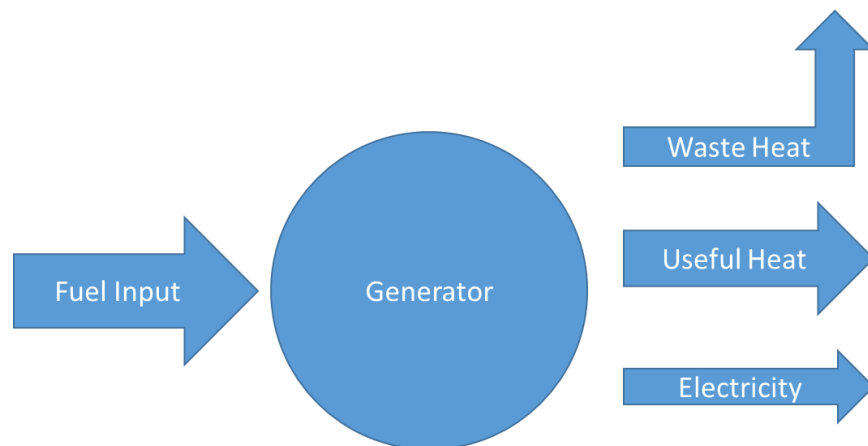
For advanced energy storage systems (AES), such as batteries, the definition of electrical efficiency is tied to the round-trip efficiency. The round-trip efficiency can be defined as follow:

$$\text{Round-Trip Electrical Efficiency} = \text{Total Electrical Output at Discharge} / \text{Total Electrical Input at Charging}$$

Useful Waste Heat Recovery

SGIP projects convert fuel into electricity and heat. CHP technologies are designed to recover some of this heat and utilize it to serve onsite thermal loads. Capturing and using waste heat to serve onsite thermal needs is referred to as “useful waste heat recovery.” Figure 4-2 illustrates a simplified representation between waste heat and useful waste heat recovery in a CHP system.

FIGURE 4-2: SIMPLIFIED CHP DIAGRAM SHOWING HEAT AND ELECTRICITY FLOWS



Useful waste heat recovery rates are typically presented in units of MBtu¹⁰ of energy recovered per kWh of electricity generated. Not all the heat generated from a project is recovered and used for onsite purposes. In some cases, the amount of waste heat that can be recovered and used for onsite needs exceeds the thermal needs of the site. In those instances, the useful waste heat recovery is limited to

¹⁰ MBtu means thousands of Btu.



the thermal demand at the site. We use literature values of useful heat recovery as well as metered useful waste heat recovery rates from SGIP projects in this study.

Annual Degradation Rates

All technologies have reduced performance as they age. We estimate annual performance degradation based on literature values and metered data on SGIP technologies operating under the SGIP. Our baseline assumption is that SGIP systems are maintained in accordance with regular maintenance schedules and annual degradation is limited to normal wear. This assumption matches the policies contained in the SGIP Handbook starting with the use of performance-based incentives (PBIs).

Table 4-4 is a listing of the operating characteristics of each of the SGIP systems evaluated in the study. The values in the table represent a mix of assumed values and observed values. For example, we assume all technologies except wind and storage comply with the expected annual capacity factor of 80%. In contrast, electrical efficiencies, useful waste heat recovery, and annual degradation values are based on metered performance of SGIP systems checked against literature values.¹¹

¹¹ Values are often based on multiple sources of information. Appendix A and the technology workbooks contained in the SGIPce model provide references for the various operating characteristics adopted for use in this study.

TABLE 4-4: SUMMARY OF OPERATING CHARACTERISTICS OF SGIP TECHNOLOGIES

Technology/Fuel Type	Nominal Rating (kW)	Annual Capacity Factor	Electrical Efficiency _{HHV}	Useful Heat Recovery (MBtu/kWh)	Annual Degradation							
Small Fuel Cells – CHP/NG	500			2,029								
Small Fuel Cells – CHP/OSB	500											
Small Fuel Cells – CHP/DBG	500			0								
Large Fuel Cells – CHP/NG	1,200			2,029								
Large Fuel Cells – CHP/OSB	1,200											
Large Fuel Cells – CHP/DBG	1,200			39%		0	5%					
Fuel Cells - Electric Only /NG	500											
Fuel Cells - Electric Only/DBG	500								49%	0	5%	
Small Gas Turbine /NG	2,500										3,564	
Small Gas Turbine/OSB	2,500										0	
Small Gas Turbine/DBG	2,500	0										
Large Gas Turbine/NG	7,000	32%	3,564		1%							
Small IC Engine/NG	500				4,630							
Small IC Engine/OSB	500				0							
Small IC Engine/DBG	500				0							
Large IC Engine/NG	1,500				4,630							
Large IC Engine/OSB	1,500			0								
Large IC Engine/DBG	1,500			27%	0	1%						
Microturbine/NG	200					7,839						
Microturbine/OSB	200					0						
Microturbine/DBG	200					21%		0	5%			
Organic Rankine Cycle/Waste Heat	500					80%		22%	0	1%		
Small Wind/Wind	50	25%	NA			NA		1%				
Large Wind/Wind	1,500							1%				
Residential Storage/NA	5	6% ¹²	90%			NA						
Non-residential Storage/NA	30		90%									
Large Storage/NA	5,000		70%						1%			
Pressure Reduction Turbine/Water Flow	500	80%	NA			0		1%				

We use emission rates from SGIP technologies and utility central station power plants in determining benefits related to avoided emissions. Under SB 861, distributed generation technologies in the SGIP must help to reduce GHG and criteria air pollutant emissions. Table 4-5 is a summary of CO₂, NO_x, and PM-10 emission factors for distributed generation technologies (see Appendix A for details). Operation of wind, the Organic Rankine Cycle, and pressure reduction turbine technologies have no emissions and

¹² Storage capacity factor is based on assumed 10% of 5,200 hours per year as per 2014 SGIP Handbook.



are evaluated on the basis of avoiding grid emissions. Storage emissions depend on the charge and discharge cycles.

TABLE 4-5: EMISSION FACTORS FOR SGIP TECHNOLOGIES

Technology	Fuel Type	Emissions Factors - CO ₂ (lbs/MWh)	Emissions Factors - NO _x (lbs/MWh)	Emissions Factors - PM10 (lbs/MWh)
Small Fuel Cells – CHP	NG	1,090	0.010	0.00002
Small Fuel Cells – CHP	OSB	0		
Small Fuel Cells – CHP	DBG	1,090		
Large Fuel Cells – CHP	NG	1,090		
Large Fuel Cells – CHP	OSB	0		
Large Fuel Cells – CHP	DBG	1,090		
Fuel Cells - Electric Only	NG	802	0.002	0.00002
Fuel Cells - Electric Only	DBG			
Small Gas Turbine	NG	1,199	0.070	0.05635
Small Gas Turbine	OSB	0		
Small Gas Turbine	DBG	1,199		
Large Gas Turbine	NG	1,199		
Small IC Engine	NG	1,422		
Small IC Engine	OSB	0		
Small IC Engine	DBG	1,422		
Large IC Engine	NG	1,422		
Large IC Engine	OSB	0		
Large IC Engine	DBG	1,422		
Microturbine	NG	1,828		
Microturbine	OSB	0		
Microturbine	DBG	1,828		
Organic Rankine Cycle/Waste Heat	NA			
Small Wind/Wind	Wind			Grid
Large Wind/Wind	Wind			
Non-residential Storage/NA	Grid			Grid
Large Storage/NA	Grid			
Pressure Reduction Turbine/Water Flow	Water			Grid

Critical Costs

What is counted as a cost, follow the modified SPM methodology and depend on the particular cost test. Costs in the PCT, TRC, and STRC tests include the capital costs for the equipment, the cost of



installing the equipment, air pollution emission controls, and other costs associated with the capital. Equipment and installation costs were obtained from interviews with manufacturers, project developers, and secondary research. The secondary research included published data, financial reports, and industry periodicals. We also developed separate cost estimates for clean-up equipment used for onsite biogas systems. Estimates of the future costs of equipment are based on learning curves as described in Section 4.3.

Other costs borne by participants include O&M expenses, fuel costs; ongoing emission offset purchases, and non-bypassable charges.

Equipment Costs

Figure 4-3 is an example of how costs are treated in the study. Cost estimates for SGIP technologies are broken into three major categories: electricity generation system, waste heat handling system, and biogas handling costs. Electricity generation system costs are further broken down into equipment, labor for installation, balance of plant (BOP), additional air pollution control costs, and other costs (as appropriate). Waste heat handling system costs are broken out by equipment, labor for installation, BOP, and other costs. Biogas handling costs are disaggregated by gas collection costs and gas clean-up costs.¹³ All equipment capital costs are provided on an “overnight” capital cost basis adjusted to 2014 values based on the Consumer Price Index.¹⁴

13 Costs for anaerobic digestion systems (e.g., covered lagoon, plug flow reactor, etc.) are not listed as costs for this study. These costs are assumed to be borne by the customer outside of the costs of generating energy from biogas.

14 “Overnight” capital costs do not take into account financing or inflation. As such, they provide a good basis for comparing costs from one project to the next.

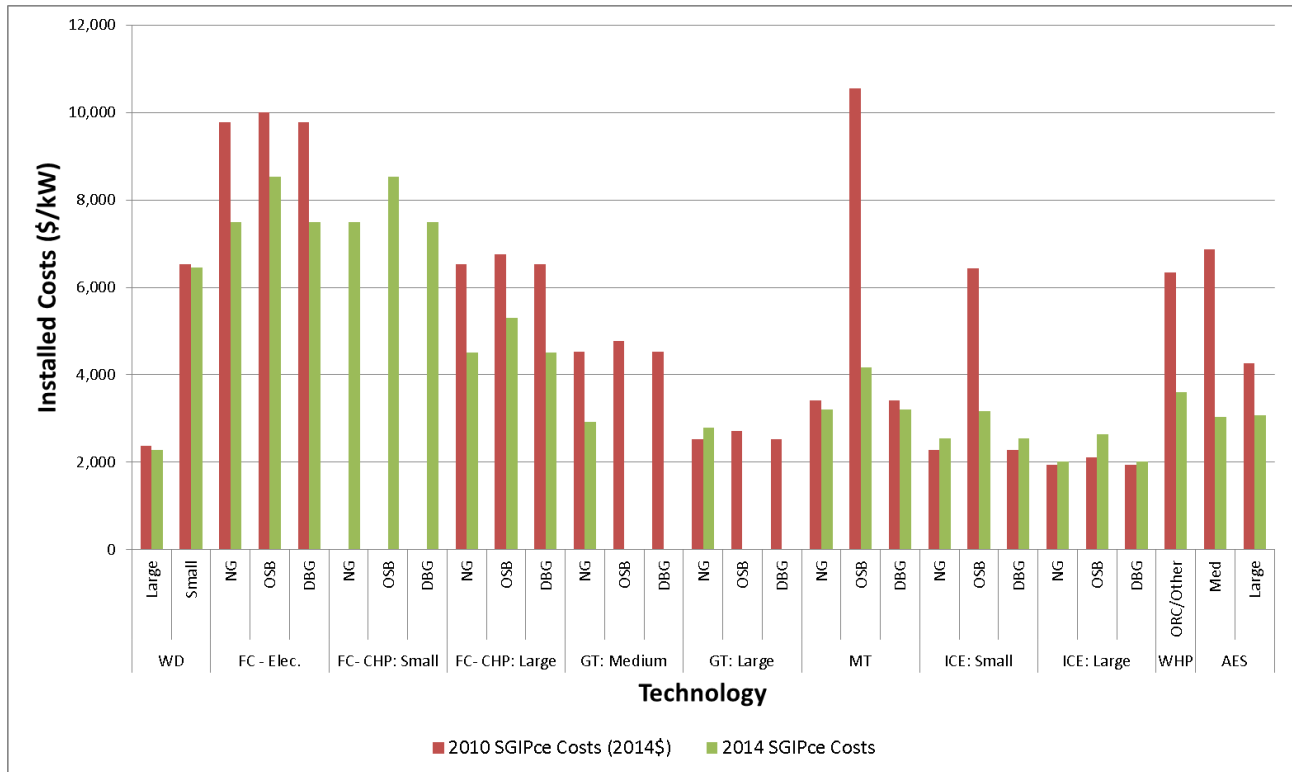


Average System Size (kW)	500	<p>Breakdown from ref 9 and 16. See sources tab</p> <p>Overnight capital cost. DOE, EPA, Oak Ridge NL (ref 9, 16, 5)</p> <p>Biogas costs developed under "Biogas_FC_Cost Ref" tab.</p> <p>See "Cost Breakdown_biogas_FC" Tab</p> <p>Ref 5 and 15. Includes stack replacement every 5 years. See sources tab.</p> <p>See "Cost Breakdown_biogas_FC" Tab</p>
<u>Electricity Generation System</u>		
Equipment	\$3,750	
Labor	\$2,625	
BOP	\$1,125	
Additional Air Pollution Control		
Other Costs		
System Cost per kW	\$7,500	
<u>Waste Heat Handling System (If Separate)</u>		
Equipment		
labor		
BOP		
Other Costs		
Waste Heat Handling Cost per kW	\$0	
Total Equipment Cost	\$ 7,500	
<u>Biogas Capital Costs</u>		
Biogas Collection	\$ 230	
Biogas clean up	\$ 807	
Other biogas treatment costs		
Total Biogas Costs per kW	\$ 1,037	
Total System Costs per kW	\$8,537	
<u>O&M Costs</u>		
Electrical	\$ 0.040	
Biogas Capture	\$ -	
Biogas Clean Up	\$ 0.11	
Air Pollution Control		
Total O&M Costs per kWh	\$ 0.1500	

FIGURE 4-3: EXAMPLE OF SUMMARIZED COSTS FOR A 500 KW FUEL CELL WITH CHP

Almost all of the equipment costs for SGIP technologies have decreased relative to the costs reported in the 2011 Cost Effectiveness Study. Figure 4-4 is a comparison of installed costs of SGIP systems in 2014 (shown as green bars) against the 2010 installed costs used in the 2011 Study. Both the 2011 values and the 2014 values have been adjusted to 2014 dollars.

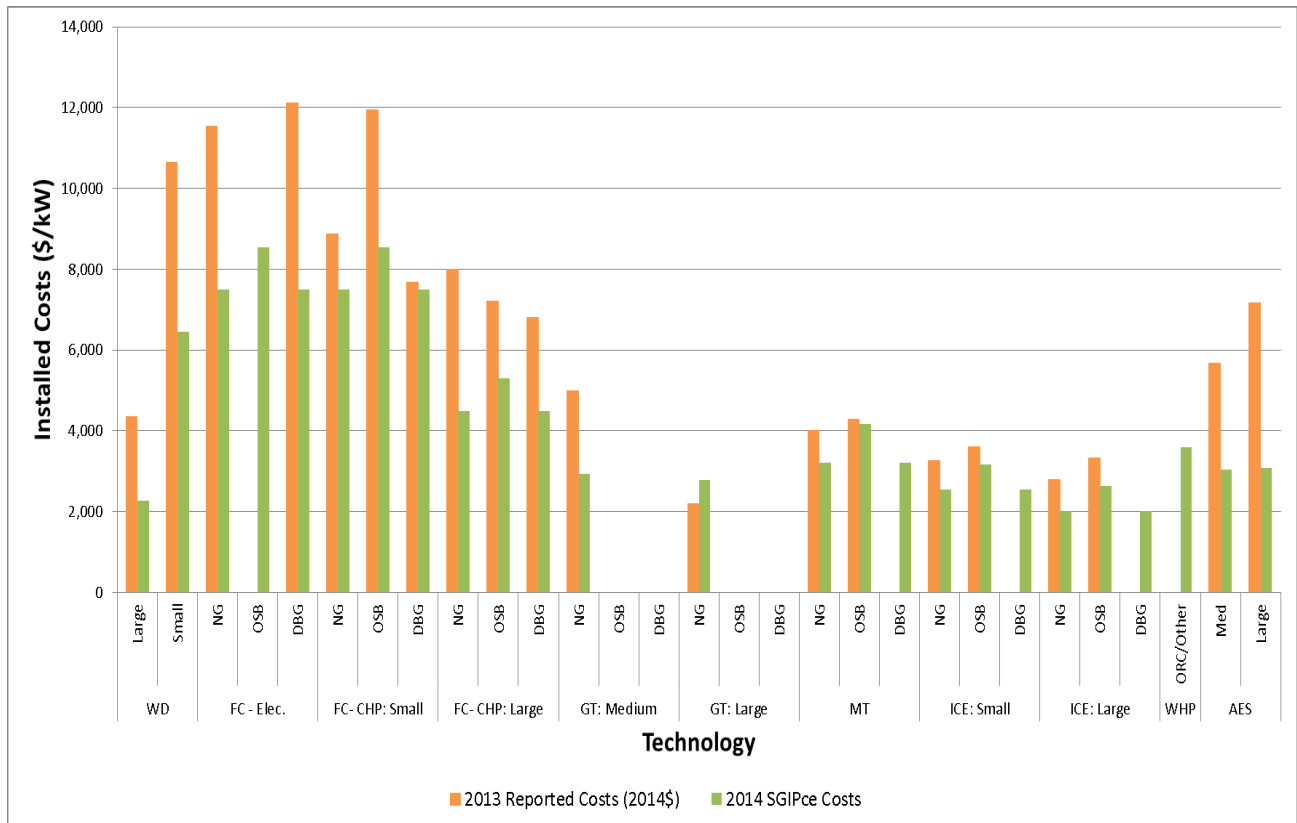
FIGURE 4-4: COMPARISON OF 2010 AND 2014 INSTALLED COSTS OF SGIP TECHNOLOGIES (2014\$)



There are some instances where 2014 estimated costs exceed the 2010 estimated costs. These instances involve primarily IC engines.

The SGIP allows use of self-reported costs by participants. Cost effectiveness analysis provides a means of independently assessing self-reported costs. Figure 4-5 compares 2013 self-reported costs in the SGIP against estimated 2014 installed SGIP costs (both are reported in 2014 dollars). In general, the estimated 2014 costs are significantly lower than the self-reported costs.

FIGURE 4-5: COMPARISON OF 2013 SELF-REPORTED COSTS IN SGIP AGAINST 2014 ESTIMATED INSTALLED COSTS (2014\$)



Operating Costs

In addition to costs of buying and installing the SGIP equipment, SGIP equipment also has ongoing or variable operating and maintenance costs. These O&M costs are included in the PCT, the TRC, and STRC tests. The O&M costs include insurance and yearly maintenance expenses. Maintenance costs include periodic overhauls or replacement of system components (e.g., replacing a portion of the stack on a regular basis in the case of fuel cells). O&M costs used in this study are based on interviews with equipment manufacturers, project developers, host sites, and secondary data (i.e., literature).

Fuel expenses for natural gas and directed biogas-fueled technologies are also included as costs in the PCT, TRC, and STRC tests. Natural gas costs can consist of three main components: an access charge, the cost of the commodity, and a gas transportation fee. Costs of natural gas are based on utility-specific non-core gas rates for commercial and government/nonprofit participants and on utility-specific core rates for residential customers.¹⁵ For commercial and government/nonprofit customers, utility-specific

¹⁵ Core natural gas customers include all residential customers regardless of the size of their loads, commercial customers with annual loads below 250,000 therms, and commercial customers with annual loads above 250,000 therms who elect to receive the higher reliability associated with core service. Non-core gas customers generally include all cogeneration, regardless of load size, and commercial customers with annual loads above



gas transportation charges are added to the non-core gas rates within the PCT test.¹⁶ Projected costs of natural gas rates going into the future are based on the California Energy Commission (CEC)'s 2010-2020 Adopted Forecast.¹⁷ For the commercial and government/nonprofit analysis, we apply non-core gas rates and the rate forecast underlying the avoided cost forecast. The TRC and STRC tests also include natural gas fuel costs. This fuel cost represents the revenue lost by the gas utility when CHP systems displace natural gas that would otherwise be purchased by the customer to meet onsite thermal energy needs. The lost revenue is estimated using the amount of gas displaced annually by the CHP system and valued at the appropriate customer non-core gas rates plus the gas transportation charges.

Directed biogas is biogas that has been procured from a location other than the customer site. The biogas is collected, cleaned, and then injected into the natural gas pipeline.¹⁸ The cost increase for the use of directed biogas as a resource is based on discussions with project developers and gas marketers using directed biogas in their projects.

Non-Bypassable Charges

When electrical load departs, utilities can bill self-generating customers with departing load charges.¹⁹ These charges are also known as non-bypassable charges or cost responsibility charges (CRC). CRCs include a number of liabilities such as Department of Water (DWR) bond charges or DWR power charges, and historic procurement charges (HPCs).²⁰ The majority of these costs are paid by SGIP systems up to a particular size or depending on how they are classified. In instances where standby charges are known, we include them as costs in the PTC test.

Standby Charges

Standby charges can be billed by the utility for the use of utility services needed to ensure reliability of service to the customer. These services can include system backup support as well as other running and quick-start capabilities. In many instances, the level of standby demand can be set by the customer.

250,000 therms. For simplicity, we have assumed all residential applications are tied to core gas rates and all non-profit and commercial applications are tied to non-core rates.

16 In general, separate gas transportation charges are not assessed against residential core customers. However, residential customers who elect to participate in core aggregation programs may be subject to separate transportation charges. For simplicity, we have assumed residential core customers are not participating in core aggregation programs.

17 CEC: "California Energy Demand 2010 – 2020 Commission Adopted Forecast," CEC-200-2009-012-CMF, December 2009

18 For more information on directed biogas, please see D.09-09-048:
http://docs.cpuc.ca.gov/word_pdf/FINAL_DECISION/107574.pdf

19 Departure of electrical load refers to a situation where the customer discontinues or reduces its purchases of bundled or direct access electricity service from the utility or where the customer purchases or consumes electricity supplied and delivered by customer generation to replace direct access purchases.

20 The DWR Power Charge has long since been replaced by the Power Charge Indifference Adjustment (PCIA).



However, standby demand can be reset by the utility as appropriate to reflect the actual required reserve capacity. We base standby charges on IOU standby S schedules.

Net metered systems and qualifying SGIP technologies can be exempted from standby charges in accordance with Public Utilities Code Sections 353.1, 353.2 and 353.3. In those instances, the qualifying systems are billed under a time of use (TOU) schedule.

Interconnection Fees

Historically, when SGIP systems have been interconnected into the electrical grid, an interconnection study is conducted by the utility, and the customer or project developer installing the SGIP system is charged for the study costs. NEM systems have historically been exempt from interconnection fees. However, if the installation of a SGIP system requires upgrades to the electrical system, the upgrades are charged to the participant. Because these benefits and costs vary widely across applications and utilities, it was not possible to include interconnection costs in this study.

Program Administrator Costs

PAs bear the cost of designing and managing the SGIP. These administrative costs are applied in the PAC, TRC, and STRC tests. We place them on a \$/kW basis using the installed capacities of the SGIP projects divided by the total program administration expenses reported to the CPUC on an annual basis. This average PA cost per kW installed is then applied to each of the evaluated SGIP technologies. The PA costs vary by PA.

Removal and Salvage Costs

Removal and salvage costs were not included in the tests. We assume the SGIP systems are operated for up to 20 years and their present value removal costs are negligible.

Critical Benefits

Like costs, the allocation of benefits can vary by the particular cost test. Within the PCT, TRC, STRC, and PAC tests, benefits are generally associated with grid costs avoided as a result of the installation of a SGIP system. However, benefits can also include bill and energy savings, incentives offered by the utility, tax credits or other financial treatment, exemptions from certain costs, and environmental credits.

Avoided Grid Costs

SGIP systems generate electricity that can be used in lieu of power supplied from the grid. Benefits include electricity purchases avoided from central station power plants and instead supplied from SGIP systems. SGIP systems can also help to offset additional T&D infrastructure as well as help “unload” T&D lines. Consequently, within the TRC, STRC, and PAC tests, benefits include deferred T&D costs and avoided line losses.



The avoided purchase of energy commodities and resource adequacy costs are evaluated on an 8,760 hours-per-year stream of avoided electricity purchases and monthly values for the avoided gas purchases. Avoided electricity and gas costs are based on the E3 electric and gas avoided cost model for DER systems. Avoided T&D costs are based on T&D avoided costs in the E3 2013 Net Energy Metering (NEM) electric and gas avoided cost model.²¹

Bill and Energy Savings

Bill and energy savings accrue as benefits to SGIP systems installed at customer sites. Electricity bill savings result from savings in demand charges as well as lower annual energy costs. For CHP systems, benefits also result from natural gas bill and energy savings. These natural gas benefits result from capture and use of waste heat produced from the electricity generation system to help meet customer onsite thermal needs. The recovered waste heat can be used to offset onsite boiler fuel or used in absorption chillers to offset cooling needs. For simplicity, we assume the recovered waste heat replaces gas that would have been used for heating water for a boiler. The efficiency of the boiler for this calculation is assumed to be 80%.

Electrical and gas bill savings for SGIP systems are based on the electrical efficiencies, capacity factors and useful waste heat rates (as appropriate for CHP systems), and electricity rates appropriate to the customer market segment. Representative electrical efficiencies, capacity factors, and useful waste heat rates for evaluated SGIP technologies are specified in Table 4-4. For each SGIP technology, an annual estimate of gas savings and avoided electricity utility purchases is derived and multiplied by the prevailing core, non-core gas rate and appropriate electrical rates based on the utility-specific location of the SGIP facility.

Electricity rates for each of the electrical IOUs are contained in the SGIPce model. For example, commercial electricity rates for PG&E include A10 TOU and E19 rates; while residential rates include E1 and TOU-D-1. SCE commercial rates include GS2 TOU and TOU-8, while SCE residential rates include Schedules D and TOU-D-1. SDG&E commercial electricity rates include Schedule AL-TOU and residential rates Schedule DR and DR-SES.

Electricity and demand charges differ based on whether the demand for electricity occurs during off peak, semi-peak, or peak hours. Electricity generated by SGIP systems helps offset the electricity demand at the customer site. Electricity bill savings are calculated by fitting the electricity rates to the hourly generation profile of the SGIP technology. A “maximum” weighted electrical rate is defined in the electricity rate workbooks used in the model. The “maximum” weighted electrical rate assumes the technology is operated all the time with a flat generation profile. When the model calculates the

²¹ Personal communications with E3. The NEM 2013 model is available through E3 but at the time of this report was not yet located on a public website. See https://www.ethree.com/public_projects/cpucNEM.php



electricity bill savings, it uses the generation profile appropriate to the SGIP technology. Maximum weighted average electrical rates for the three major electrical IOUs are listed in Table 4-6.²²

TABLE 4-6: WEIGHTED ELECTRICAL IOU RATES 2011-2034 (NOMINAL \$/KWH)

IOU	RATE	2011	2012	2013	2014	2015	2016	2017	2018
SCE	GS2TOU	\$0.093	\$0.092	\$0.097	\$0.100	\$0.103	\$0.107	\$0.110	\$0.114
PG&E	A10TOU	\$0.159	\$0.156	\$0.155	\$0.157	\$0.162	\$0.168	\$0.173	\$0.178
SDG&E	ALTOU	\$0.140	\$0.139	\$0.143	\$0.147	\$0.151	\$0.157	\$0.161	\$0.166
IOU	RATE	2019	2020	2021	2022	2023	2024	2025	2026
SCE	GS2TOU	\$0.118	\$0.122	\$0.126	\$0.130	\$0.133	\$0.137	\$0.142	\$0.146
PG&E	A10TOU	\$0.184	\$0.190	\$0.195	\$0.201	\$0.207	\$0.214	\$0.220	\$0.226
SDG&E	ALTOU	\$0.171	\$0.176	\$0.182	\$0.187	\$0.193	\$0.199	\$0.205	\$0.211
IOU	RATE	2027	2028	2029	2030	2031	2032	2033	2034
SCE	GS2TOU	\$0.150	\$0.155	\$0.159	\$0.164	\$0.169	\$0.174	\$0.179	\$0.185
PG&E	A10TOU	\$0.233	\$0.240	\$0.247	\$0.255	\$0.262	\$0.270	\$0.278	\$0.286
SDG&E	A6TOU	\$0.217	\$0.224	\$0.231	\$0.238	\$0.245	\$0.252	\$0.260	\$0.268

The SGIP technology generation profile is important in setting the appropriately weighted average electricity rates. Table 4-7 shows an example of the average weighted electricity rates that are produced by the model when used for specific SGIP technologies. As shown, the electricity rates vary in accordance with the generation profile of the SGIP technology.

TABLE 4-7: EXAMPLE OF AVERAGE WEIGHTED ELECTRICITY RATES BY SGIP TECHNOLOGY

Technology	2014	2015	2016	2017	2018	2019	2020	2021	2022	2023	2024
500 kW Fuel Cell - Electric	\$0.154	\$0.159	\$0.164	\$0.169	\$0.175	\$0.180	\$0.185	\$0.191	\$0.197	\$0.203	\$0.209
2.5 MW Gas Turbine	\$0.140	\$0.144	\$0.150	\$0.155	\$0.160	\$0.166	\$0.171	\$0.177	\$0.183	\$0.189	\$0.195
1.5 MW IC Engine	\$0.149	\$0.154	\$0.160	\$0.164	\$0.170	\$0.175	\$0.181	\$0.187	\$0.193	\$0.199	\$0.205
30 kW Energy Storage	\$0.499	\$0.513	\$0.533	\$0.546	\$0.563	\$0.580	\$0.597	\$0.615	\$0.634	\$0.653	\$0.673

22 Two sets of electricity tariffs each for SCE, PG&E, and SDG&E were selected for use in the cost effectiveness evaluation. For SCE, the selected tariffs were GS2 TOU and TOU8. For PG&E, the selected tariffs were A10 TOU and E19. For SDG&E, the tariffs were A6 TOU and AL TOU. Future rates were based on annual growth rates contained in the CEC’s “California Energy Demand 2010 – 2020 Commission Adopted Forecast” and adjusted assuming 2% annual inflation



Similarly, the model uses non-core gas rates in calculating gas bill savings. The non-core gas rates are taken from the E3 NEM avoided cost model and based on the CEC Annual Average Natural Gas Price Forecast. The non-core rates used in the model are listed in Table 4-8.

TABLE 4-8: NON-CORE GAS RATES OVER TIME 2012-2035 (NOMINAL \$/THERM)

Year	2012	2013	2014	2015	2016	2017	2018	2019
Gas Price	\$3.49	\$4.34	\$3.98	\$4.08	\$4.16	\$4.27	\$4.40	\$4.55
Year	2020	2021	2022	2023	2024	2025	2026	2027
Gas Price	\$4.71	\$4.88	\$5.05	\$5.24	\$5.43	\$5.84	\$5.94	\$6.01
Year	2028	2029	2030	2031	2032	2033	2034	2035
Gas Price	\$6.06	\$6.13	\$6.14	\$6.19	\$6.23	\$6.27	\$6.30	\$6.34

Rebates and Incentives

Rebates and incentives represent a major benefit received by participants for qualifying technologies and systems. This benefit is included only in the PCT. In this study, we use SGIP incentives listed in the SGIP Handbook beginning in 2013 and published in 2014. In general, we use SGIP incentive values in the PCT.

TABLE 4-9: INCENTIVE LEVELS UNDER THE SGIP

Category	Technology Type	2013 \$/W	2014 \$/W
Renewable and Waste Energy Recovery	Wind Turbine	\$1.19	\$1.13
	Waste Heat to Power	\$1.19	\$1.13
	Pressure Reduction Turbine	\$1.19	\$1.13
Non-Renewable Conventional CHP	Internal Combustion Engine – CHP	\$0.48	\$0.46
	Microturbine – CHP	\$0.48	\$0.46
	Gas Turbine – CHP	\$0.48	\$0.46
Emerging Technologies	Advanced Energy Storage	\$1.80	\$1.62
	Biogas Adder ²³	\$1.80	\$1.62
	Fuel Cell – CHP or Electric Only	\$2.03	\$1.83

²³ The biogas incentive is an adder that may be used in conjunction with fuel cells or any conventional CHP technology.



An additional incentive of 20% is provided for the installation of eligible DG or AES technologies from a California supplier. SGIP incentives are paid up to 3 MW of capacity with tiered incentive rates. For projects that are greater than 1 MW, the incentives identified in Table 4-9 decline according to the schedule shown in Table 4-10.

TABLE 4-10: INCENTIVE RATE TIERS

Capacity (MW)	Incentive Rate (Pct. Of Baseline)
0 – 1	100%
1 – 2	50%
2 – 3	25%

SGIP incentive levels also decline annually. The rate of annual incentive decline (assumed to begin in 2015) is shown in Table 4-11.

TABLE 4-11: RATE OF INCENTIVE DECLINE

Technology Type	Yearly Incentive Decline Rate
Renewable, Waste Energy Recovery, Conventional CHP	5%
Emerging Technologies	10%

Net Energy Metering Bill Credits

Additional benefits to participants are NEM credits that customers receive from the IOUs when they export power to the grid. This export occurs when the power generated from the SGIP-incented technology exceeds the energy needs of the site at the time of production and is reflected as a bill credit to the participating customer.

Environmental Benefits

SGIP systems provide environmental benefits in two ways. First, the installed SGIP systems avoid the need for participating customers to procure most of their electricity from central station power plants and so, avoid emissions otherwise produced by the grid. We take into account the net difference between emissions produced from the SGIP system and emissions produced from the grid. Net reductions in emissions are counted as benefits. Secondly, use of recovered waste heat by CHP systems offsets the need to produce thermal energy from onsite boilers. This avoids emissions that would otherwise be produced from combustion of natural gas in the onsite boilers. The avoided environmental emissions associated with decreased use of electricity generated at central station plants and reduced natural gas consumption in onsite boilers are captured in the E3 avoided cost calculations. These



benefits are applied to the TRC and the STRC tests. Table 4-12 lists the monetized value of CO₂ emissions from 2011 through 2034 as provided in the E3 avoided cost calculations. The model uses the mid-values as the “Baseline” output. The high-values are used in the model to produce the “High GHG cost” outputs.

TABLE 4-12: CO₂ EMISSION VALUES 2010–2034 (NOMINAL \$ PER TON OF CO₂)

Year	2011	2012	2013	2014	2015	2016	2017	2018
Mid Value Case of CO ₂ Emissions	\$10	\$13.62	\$22.50	\$26.31	\$28.13	\$30.14	\$32.27	\$34.55
High Value Case of CO ₂ Emissions	\$10	\$13.62	\$42.8	\$45.8	\$49	\$52.439	\$56.1	\$60.03
Year	2019	2020	2021	2022	2023	2024	2025	2026
Mid Value Case of CO ₂ Emissions	\$34.55	\$36.97	\$39.542	\$42.22	\$45.1	\$48.16	\$51.45	\$54.94
High Value Case of CO ₂ Emissions	\$64.23	\$68.73	\$73.54	\$78.69	\$84.19	\$90.09	\$96.39	\$103.14
Year	2027	2028	2029	2030	2031	2032	2033	2034
Mid Value Case of CO ₂ Emissions	\$58.73	\$62.76	\$67.09	\$71.65	\$73.08	\$74.54	\$76.03	\$77.54
High Value Case of CO ₂ Emissions	\$110.36	\$118.09	\$126.35	\$128.88	\$131.46	\$134.09	\$136.77	\$139.5

Reliability Benefits

SGIP systems may improve overall electrical system reliability under certain circumstances. For example, because they are dispersed throughout the electricity system, there is less chance that all SGIP systems will go offline at the same time. When operated in parallel to the grid or if configured into microgrids, SGIP systems can provide utility customers with power even when the grid is down. For this benefit we apply the E3 electrical avoided cost model, which assumes reductions in demand caused by SGIP systems have at least roughly the same reliability impacts as changes in demand caused by energy efficiency. This benefit is applied in the PAC, TRC, and STRC tests. While customers also benefit from increased reliability of the grid (for example through decreased downtime), we are not able to monetize these benefits to participants.

Tax Credits and Depreciation

Customers installing SGIP systems are likely to benefit from the federal investment tax credit (ITC) and acceleration of depreciation expenses under federal tax code. These benefits are included in both the PCT and STRC tests. The TRC and STRC tests also incorporate the federal income tax implications associated with SGIP technology operating costs. Specifically, the federal income tax code allows customer host sites to reduce their taxable income by their business operating costs, including the

operating and maintenance costs of SGIP technologies. For SGIP technologies fueled by natural gas, directed biogas, and onsite biogas, the operating cost and the resulting reduction in tax liabilities or increase in tax refund may be substantial. The PCT incorporates both the state and the federal income tax implications associated with SGIP technology operating costs. Table 4-13 lists the values for ITC and depreciation used in the evaluation.

TABLE 4-13: ITC AND DEPRECIATION TERMS ALLOCATED TO SGIP TECHNOLOGIES

Category/Technology	ITC (%)				Depreciation
	2013	2014	2015	2016	Term (Years)
Renewable and Waste Energy Capture					
Wind Turbine	30%	0%	0%	0%	5
Waste Heat to Power Technologies ²⁴	0%	0%	0%	0%	5
Pressure Reduction Turbine	0%	0%	0%	0%	5
Conventional CHP					
Internal Combustion Engine – CHP	10%	10%	10%	10%	5
Microturbine – CHP	10%	10%	10%	10%	5
Gas Turbine – CHP	10%	10%	10%	10%	5
Emerging Technologies					
Advanced Energy Storage ²⁵	0%	0%	0%	0%	15
Biogas ²⁶					10
Fuel Cell – CHP or Electric Only	30%	30%	30%	30%	5

Departing Load Exemptions

SGIP technologies of certain sizes and fueled by renewable resources can be exempt from departing load charges. Exemptions from departing load charges count as costs in the TRC and STRC tests and as benefits to participants in the PCT.

24 Waste heat to power currently does not receive any ITC unless it is a CHP technology. If it is CHP, the ITC follows the ITC levels for CHP.

25 Storage currently qualifies for the ITC only if it is combined with solar. This study only examines stand-alone solar PV so we have set the ITC to zero.

26 Biomass is not treated separately in the ITC. The ITC depends on the technology and the application. For example, if biogas is used in an IC engine-CHP application, it receives the ITC available for CHP. A fuel cell powered solely by biogas would receive the ITC available to fuel cells.

TABLE 4-14: SUMMARY OF DEPARTING LOAD EXEMPTIONS BY SGIP TECHNOLOGY AND FUEL

Technology	Fuel	Departing Load Charge
Fuel Cell	DIRBGas and NG	Exempt until 1 MW then subject to some charges above 1 MW if defined as ultra clean
Fuel Cell	OSBGas	Exempt regardless of size
Gas Turbines	DIRBGas and NG	Exempt up to 1 MW , then subject to DL
Gas Turbines	OSBGas	Exempt regardless of size
IC Engines	DIRBGas and NG	Exempt up to 1 MW , then subject to DL
IC Engines	OSBGas	Exempt regardless of size
Microturbines	DIRBGas and NG	Exempt under 1 MW
Microturbines	OSBGas	Exempt regardless of size
Organic Rankine Cycle	NA	Exempt under 1 MW
Advanced Energy Storage	NA	Exempt under 1 MW
Wind	NA	Exempt under 1 MW

5 THE SGIP COST EFFECTIVENESS MODEL: SGIP_{ce}

The previous sections described our overall approach in treating the cost effectiveness of SGIP technologies. We identified critical cost and benefit components and pointed out important assumptions. In this section, we identify the 2014 SGIP_{ce} model objectives, overall approach, and structure.

A more detailed explanation of the mechanics and the specific equations used in calculating the different cost tests is contained in Appendix E.

5.1 MODEL OBJECTIVES

Our overall purpose in developing an analytical cost effectiveness model is to enable calculation of cost effectiveness results for the TRC, STRC, PAC, and PCT tests over a variety of SGIP technologies and market conditions. The resulting 2014 SGIP_{ce} model is designed to provide a publicly available modeling tool that is relatively easy to use and provides users with flexibility. We intend that the model allow the CPUC, utilities, and distributed generation and storage technology stakeholders the ability to evaluate the current and future cost effectiveness of individual distributed generation and storage technology technologies or a portfolio of these technologies (i.e., SGIP).

Specific model objectives include the following:

- » The model is intended to be transparent in the inputs placed into it, the manner in which the inputs are treated and how results are calculated. The model is also dynamic, enabling users to modify the model and make model runs using alternative assumptions.
- » The model is developed in Excel 2010 using Visual Basic and the code is visible using a Visual Basic editor.
- » The report includes a User Guide (Appendix D), which walks users through the various pull down menus, entries, and resulting outputs.
- » Users can overwrite values in the model to deal with a variety of different conditions than those available in the model including different system costs, operating profiles, and treatment of useful waste heat recovery.
- » Uses the SPM tests modified in accordance with the August 2009 ALJ ruling to evaluate SGIP cost effectiveness. The model specifically treats the following tests:
 - > Participant Cost Test
 - > Total Resource Cost Test
 - > Societal Total Resource Cost Test
 - > Program Administrator Cost Test

- » Provides comprehensive coverage of distributed generation and storage technologies eligible under the SGIP.
- » Modeled technologies include wind turbines; pressure reduction turbines; stand-alone energy storage systems; Organic Rankine Cycle waste heat to power systems; and IC engines, gas turbines, microturbines, and fuel cells powered by natural gas, directed biogas, or onsite biogas.
- » The model does not treat solar PV systems or storage linked with PV as these technologies are covered in separate cost effectiveness studies.^{1,2}
- » Allows evaluation of SGIP technologies with 2014 costs and how these SGIP costs may change in the future based on learning curves.
- » Evaluations of future electric and gas rates use CEC electric and gas rate forecasts.
- » Future costs of SGIP technologies are based on learning curves developed from historic technology production volumes and prices.
- » Enables insights into the impact of changing incentive levels among different technologies.
- » Generates modified internal rates of returns (MIRR) for the baseline cases on “no incentive” and current (2014) incentive level; plus, generates incentive levels corresponding to MIRR levels ranging from 5 to 15% at individual percentage point increases.
- » The model can be run on individual technologies or a portfolio of technologies selected by the user.
- » The user has the ability to run the selected technologies with associated fuels (e.g., natural gas, directed biogas, onsite biogas), with individual IOUs or groups of IOUs, with selected market segments (i.e., residential, non-residential and government/non-profit); and with associated electric tariffs.
- » The model produces levelized lifetime values and calculates a levelized cost of electricity (LCOE) for each selected technology for each test.
- » The model generates graphical results showing the different test results (e.g., STRC, PCT, PAC) when evaluating a portfolio of technologies at selected years.
- » The model generates graphical results showing cost and benefit components at selected years for the selected individual technologies.

1 PV cost effectiveness is covered in the report *California Solar Initiative Cost Effectiveness Evaluation*, April 2011; from https://ethree.com/documents/CSI/CSI%20Report_Complete_E3_Final.pdf

2 PV used in combination with storage is assumed to fit under NEM. NEM cost effectiveness is covered in the report *California Net Energy Metering (NEM) Draft Cost---Effectiveness Evaluation*, September 26, 2013; from <http://www.cpuc.ca.gov/NR/rdonlyres/BD9EAD36-7648-430B-A692-8760FA186861/0/CPUCNEMDraftReport92613.pdf>

5.2 MODEL APPROACH

The underlying foundation of the 2014 SGIPce model is a series of critical inputs treated through a calculation engine to generate costs and benefits in accordance with modified SPM tests.

The model is pre-populated with critical inputs needed to conduct PCT, TRC, STRC and PAC test runs. These critical inputs include information on SGIP technologies (e.g., current and projected future system costs, O&M costs, air pollution emission rates, useful waste heat recovery rates, etc.), financial (e.g., discount or interest rates, taxes, etc.) and market conditions (e.g., inflation, escalation), electric and gas rates for each of the three major California IOUs that are applicable to different SGIP technologies within the appropriate market segment, avoided cost components based on E3's 2013 NEM avoided cost model,³ and information on adoption of SGIP technologies from 2014 through 2024. Model users can assume the pre-populated values or change them to develop a customized model.

The critical inputs are assembled into a variety of Excel workbooks joined together through the calculation engine. When opening the SGIPce model, users are presented with an opening screen as shown in Figure 5-1.

FIGURE 5-1: SCREENSHOT OF OPENING SCREEN OF SGIPce MODEL

Global Assumptions

Program Scenario Name	Base Case
Version Description	NewInputs
Default Year	2014
Save Calc for each line?	Yes
Store Results by Utility?	No
Update/Replace Results?	No
Save MIRR 10 - 15	No

Batch Process

- Batch Process: No Screen Updating
- Batch Process: View Screen Updating
- Batch Process: Run Unattended
- Set Run Tech Flag Off
- Reset Progress Ratio Override
- Set Run Tech Flag On
- Clear Filters

Technology Definitions

Run Number	Run Technology Flag	Technology Name	Sector	Fuel Type	Utility	Climate Region	Utility Ra	Financing Option	Rebate Type	Progress Ratio
1	No	Gas Turbine (<= 3 MW)	Commercial	Natural Gas	PG&E	Coast	A10TOU	Debt/Equity	None	NA
3	No	Gas Turbine (<= 3 MW)	Commercial	Direct Bio-Gas	PG&E	Coast	A10TOU	Debt/Equity	None	NA
4	No	Gas Turbine (<= 3 MW)	Commercial	Natural Gas	PG&E	Inland	A10TOU	Debt/Equity	None	NA
6	No	Gas Turbine (<= 3 MW)	Commercial	Direct Bio-Gas	PG&E	Inland	A10TOU	Debt/Equity	None	NA
7	No	Gas Turbine (<= 3 MW)	Commercial	Natural Gas	SCE	Coast	GS2TOU	Debt/Equity	None	NA
9	No	Gas Turbine (<= 3 MW)	Commercial	Direct Bio-Gas	SCE	Coast	GS2TOU	Debt/Equity	None	NA
10	No	Gas Turbine (<= 3 MW)	Commercial	Natural Gas	SCE	Inland	GS2TOU	Debt/Equity	None	NA
12	No	Gas Turbine (<= 3 MW)	Commercial	Direct Bio-Gas	SCE	Inland	GS2TOU	Debt/Equity	None	NA
13	No	Gas Turbine (<= 3 MW)	Commercial	Natural Gas	SDG&E	Coast	A6TOU	Debt/Equity	None	NA
15	No	Gas Turbine (<= 3 MW)	Commercial	Direct Bio-Gas	SDG&E	Coast	A6TOU	Debt/Equity	None	NA
16	No	Gas Turbine (<= 3 MW)	Commercial	Natural Gas	SDG&E	Inland	A6TOU	Debt/Equity	None	NA
18	No	Gas Turbine (<= 3 MW)	Commercial	Direct Bio-Gas	SDG&E	Inland	A6TOU	Debt/Equity	None	NA
37	No	Fuel Cells (1.2 MW)	Commercial	Natural Gas	PG&E	Coast	A10TOU	Debt/Equity	None	NA
39	No	Fuel Cells (1.2 MW)	Commercial	Direct Bio-Gas	PG&E	Coast	A10TOU	Debt/Equity	None	NA
40	No	Fuel Cells (1.2 MW)	Commercial	Natural Gas	PG&E	Inland	A10TOU	Debt/Equity	None	NA
42	No	Fuel Cells (1.2 MW)	Commercial	Direct Bio-Gas	PG&E	Inland	A10TOU	Debt/Equity	None	NA
43	No	Fuel Cells (1.2 MW)	Commercial	Natural Gas	SCE	Coast	GS2TOU	Debt/Equity	None	NA
45	No	Fuel Cells (1.2 MW)	Commercial	Direct Bio-Gas	SCE	Coast	GS2TOU	Debt/Equity	None	NA
46	No	Fuel Cells (1.2 MW)	Commercial	Natural Gas	SCE	Inland	GS2TOU	Debt/Equity	None	NA
48	No	Fuel Cells (1.2 MW)	Commercial	Direct Bio-Gas	SCE	Inland	GS2TOU	Debt/Equity	None	NA
49	No	Fuel Cells (1.2 MW)	Commercial	Natural Gas	SDG&E	Coast	A6TOU	Debt/Equity	None	NA
51	No	Fuel Cells (1.2 MW)	Commercial	Direct Bio-Gas	SDG&E	Coast	A6TOU	Debt/Equity	None	NA
52	No	Fuel Cells (1.2 MW)	Commercial	Natural Gas	SDG&E	Inland	A6TOU	Debt/Equity	None	NA
54	No	Fuel Cells (1.2 MW)	Commercial	Direct Bio-Gas	SDG&E	Inland	A6TOU	Debt/Equity	None	NA

3 The avoided costs used in this model are those developed by E3 for a 2013 NEM evaluation. See: https://www.ethree.com/public_projects/cpucNEM.php



Users have a number of options at this point. They can select different SGIP technologies to evaluate and they can select fuel type, market sector, utility, rate schedule, climate zone, financing options and type of incentive (i.e., upfront capacity-based or performance-based). The model can run individual technologies or groups of technologies. Users can also select to have the model run results at different incentive levels to generate the influence of changes in incentive levels on the MIRR.

Once the user has made their selections, they run the model through a batch processor. The SGIPce model uses the critical inputs to compile annual cash flows based on cost and benefit components. Figure 5-2 shows representative levelized lifetime values for different cost and benefit components generated by the SGIPce model.

FIGURE 5-2: SCREEN SHOT OF LEVELIZED LIFETIME VALUES GENERATED IN MODEL

Levelized Lifetime Values			2014	2015	2016	2017	2018	2019
Levelized Cost of Generation (\$/kWh)	Discount Rate	Current Period	\$0.15	\$0.14	\$0.14	\$0.15	\$0.15	\$0.14
		\$0.1458						
% Financed w/ equity		30.00%	30.0%	30.0%	30.0%	30.0%	30.0%	30.0%
Upfront rebate	Participant	\$0	\$0	\$0	\$0	\$0	\$0	\$0
	Societal	\$0	\$0	\$0	\$0	\$0	\$0	\$0
	Utility	\$0	\$0	\$0	\$0	\$0	\$0	\$0
Cost of Generation (\$)	Participant	\$1,404,448	\$1,404,448	\$1,389,387	\$1,375,661	\$1,405,645	\$1,397,388	\$1,391,341
	Societal	\$1,391,738	\$1,391,738	\$1,376,814	\$1,363,212	\$1,392,924	\$1,384,742	\$1,378,750
	Utility	\$1,405,950	\$1,405,950	\$1,390,872	\$1,377,132	\$1,407,148	\$1,398,882	\$1,392,828
Operating Revenue	Participant	\$1,404,448	\$1,404,448	\$1,389,387	\$1,375,661	\$1,405,645	\$1,397,388	\$1,391,341
	Societal	\$1,391,738	\$1,391,738	\$1,376,814	\$1,363,212	\$1,392,924	\$1,384,742	\$1,378,750
	Utility	\$1,405,950	\$1,405,950	\$1,390,872	\$1,377,132	\$1,407,148	\$1,398,882	\$1,392,828
State Rebate	Participant	\$0	\$0	\$0	\$0	\$0	\$0	\$0
	Societal	\$0	\$0	\$0	\$0	\$0	\$0	\$0
	Utility	\$0	\$0	\$0	\$0	\$0	\$0	\$0
REC Revenue	Participant	\$0	\$0	\$0	\$0	\$0	\$0	\$0
	Societal	\$0	\$0	\$0	\$0	\$0	\$0	\$0
	Utility	\$0	\$0	\$0	\$0	\$0	\$0	\$0
Total Revenue	Participant	\$1,404,448	\$1,404,448	\$1,389,387	\$1,375,661	\$1,405,645	\$1,397,388	\$1,391,341
	Societal	\$1,391,738	\$1,391,738	\$1,376,814	\$1,363,212	\$1,392,924	\$1,384,742	\$1,378,750

When a batch run is executed, the model will create aggregated results for the entire list of selected technologies and individual technology calculation workbooks for each selected technology. The aggregated results are stored in the Results directory while the individual technology workbooks are stored in the CalcEngines directory in their own subdirectory.

The model outputs data at both the technology and program level. The application of technology adoptions allows for the calculation of the tests at the technology, sector, and overall levels. The cost effectiveness calculations are performed at the technology level. The adoption inputs are incorporated to allow for the aggregate calculation of the cost effectiveness inputs and test values across technologies, sectors, and for the overall portfolio of technologies.

Results from the model are provided in both tabular and graphical formats. The program-level results list the program-level benefits and costs, the energy savings, and the rebates included in the model. Individual technology runs generate results on benefit-to-cost ratio, breakdowns of cost and benefit components, and MIRR results.



Table 5-1 shows a representative set of tabular results for a PCT run on an individual technology. The tabular data groups the components by cost or benefit and provides values for selected years. In addition, the table contains a summary of the total and annual net benefits⁴ and the calculated annual benefit-to-cost ratio for the test.⁵

TABLE 5-1: REPRESENTATIVE PCT COST AND BENEFIT TABLE SUMMARY RESULTS

PCT	2014	2017	2020	2024
Costs				
System Cost	\$310,794	\$325,361	\$340,612	\$362,063
O&M Cost	\$1,230,909	\$1,032,509	\$866,882	\$687,867
Fueling Cost	\$1,150,540	\$1,270,601	\$1,392,797	\$1,564,327
Standby Charges	\$326,000	\$363,301	\$406,898	\$473,689
Total Costs	\$3,018,243	\$2,991,772	\$3,007,189	\$3,087,945
Benefits				
Total Rebate	\$--	\$--	\$--	\$--
REC Revenue	\$--	\$--	\$--	\$--
State Taxes	\$249,429	\$245,042	\$244,337	\$248,586
Federal Taxes	\$925,215	\$884,425	\$881,880	\$897,216
Avoided Bills	\$1,249,168	\$1,367,478	\$1,495,822	\$1,685,188
Total Benefits	\$2,423,812	\$2,496,945	\$2,622,039	\$2,830,991
Net Benefits	\$(594,430)	\$(494,827)	\$(385,150)	\$(256,954)
Ratio	0.80	0.83	0.87	0.92

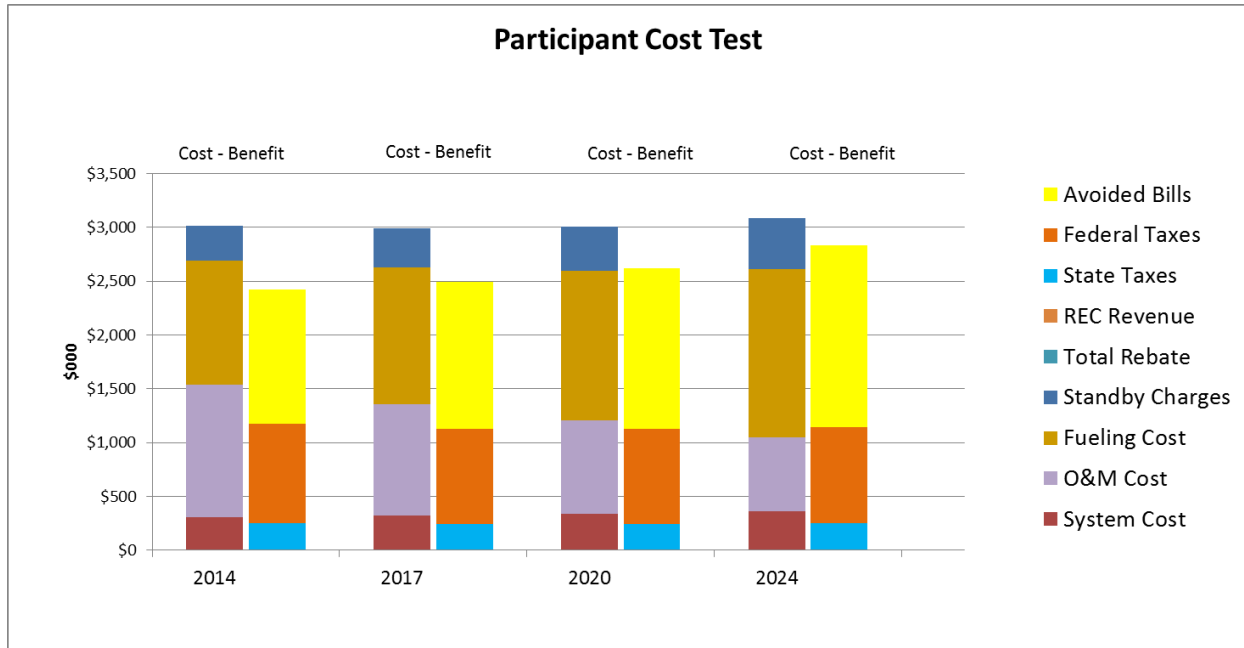
4 Annual net benefits are a valuable output of the model as they show whether the examined technology is making or losing money for each year over the course of the 20 years.

5 Note that this table shows annual benefit-to-cost ratio. However, the model calculates an overall benefit-to-cost ratio.



Figure 5-3 provides a graphical presentation of the same results broken down by cost and benefit components and showing the trends over the selected years.

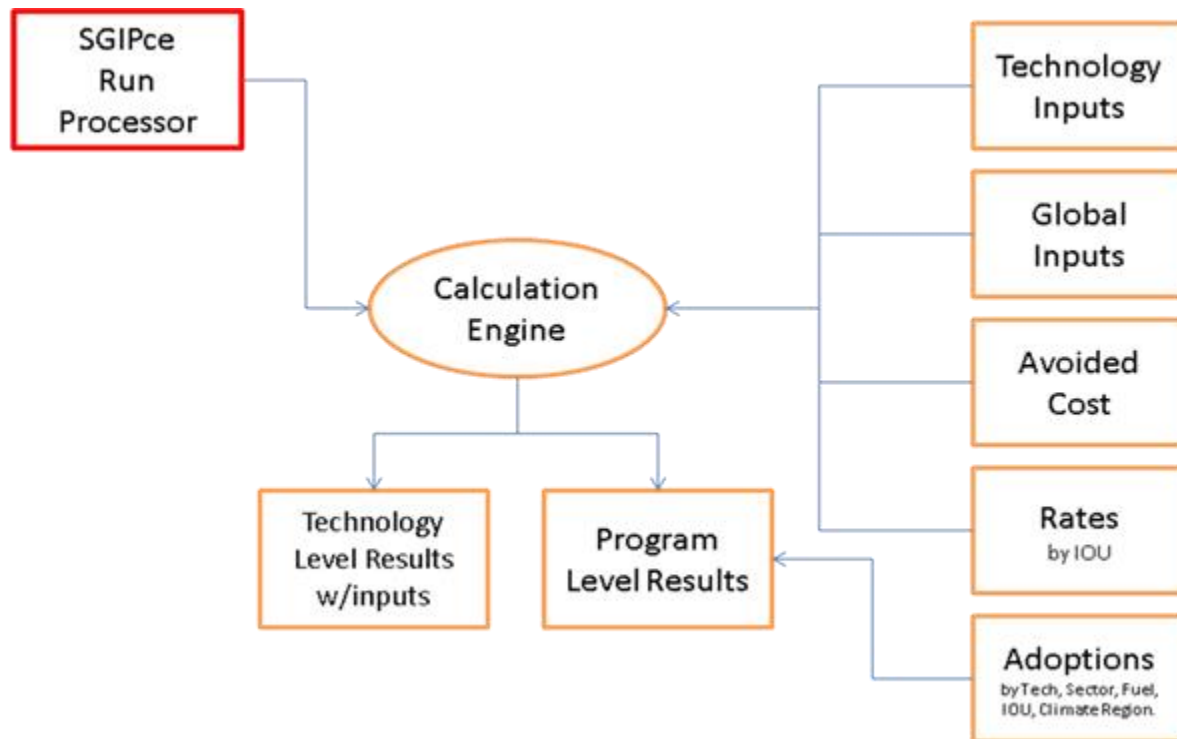
FIGURE 5-3: GRAPHICAL PRESENTATION OF COST TEST RESULTS



5.3 MODEL STRUCTURE

The SGIPce model is structured around the critical inputs, the SGIPce run processor, the calculation engine, and the technology and program level output results. Figure 5-4 depicts the overall structure of the 2014 SGIPce model.

FIGURE 5-4: OVERALL STRUCTURE OF THE SGIPce MODEL



Critical Inputs

The model consists of five primary categories of inputs:

- » SGIP technology inputs, which includes current and projected future system costs, O&M costs, air pollution emission rates, useful waste heat recovery rates (for CHP applications), capacity factors, and annual degradation rates. The model is populated with inputs for a variety of SGIP technologies but, as indicated earlier, users have the ability to change these inputs if needed.
- » Global inputs, which consists of technology-independent information including such items as financing options, discount rates, taxes, insurance, inflation, and escalation on labor. This group of information also includes current and projected values for emission credits as well as GHG values and projected GHG electric and gas multipliers.
- » Avoided Cost inputs, which are made up of four workbooks containing the electric and gas avoided costs. The electric avoided costs are stored in a workbook that holds the values by utility and climate region (i.e., coastal and inland) and for the base case and high cost scenario of avoided cost. The

avoided costs are sets of 8,760 hourly values based on the 2009 calendar and span the period from 2012 through 2044. These values were derived from the E3 2013 NEM avoided cost workbook.⁶ To calculate the model inputs for the avoided cost benefits, a production curve for the evaluated technology is supplied to the workbook. The production curve and the yearly 8760 avoided cost values are multiplied leading to the calculation of a stream of annual values that are then supplied to the calculation engine. The gas avoided cost data are similar in nature to the electric avoided costs with the following differences:

- > The gas avoided costs differ by sector and are aggregated to a monthly level.
 - > The gas avoided costs are developed by sector because the GHG emissions differ by the underlying technology.
 - > The gas avoided costs are not provided at the 8760 level because gas consumption and heat usage is only monitored monthly; therefore, the avoided costs are supplied at that level.
 - > Two production curves are supplied to the workbook: therms required to fuel the CHP DG technology and therms saved from capturing the heat from the CHP DG technology. As expected, two streams of values are calculated from these production curves and supplied back to the calculation engine, one for each production curve.
- » Electric and gas rate inputs, which consist of a number of workbooks designed to supply utility rate information to the model. Rates are defined for both the residential and non-residential sectors. Due to the complex nature of rates, the non-residential rates are defined in separate workbooks for each utility and are rate-defined. For the residential sector, it was possible to combine all rate definitions into one workbook. There is also a third workbook that defines the gas rates for the non-residential sector. The non-residential gas rates workbook provides rates from non-core gas customers with a reduced transmission and distribution fee for CHP gas required to run the DG systems. This workbook also provides the rate information, with the standard T&D fee, for the valuation of the natural gas saved from capturing the heat generated by the CHP DG system. A new feature to this 2014 version of SGIPce is standby rate. A standby rate workbook has been added that uses standby tariffs from each of the IOUs along with assumptions about when standby rates apply during the year to allow calculation of standby charges. Assumptions regarding hours when standby charges apply are based on the top 50 hours of CAISO demand and representative hourly capacity factors for self-generation systems during those hours.
- » Adoption inputs, which consists of a single workbook that supplies technology adoptions data to the results workbook upon completion of each batch run. Adoptions in this workbook have been defined for the different combination of SGIP technologies examined in the study. The adoptions are defined annually and span from 2012 through 2024.

⁶ See https://www.ethree.com/public_projects/cpucNEM.php



SGIPce Run Processor

The SGIPce Run Processor is the controlling workbook for the model. It is where the user starts the system and where the batch runs are defined. Once a run is defined, the user presses a processor button that calls routines in the Calculation Engine. Pressing the processor button starts the process of calculating the results as defined by the user. The steps associated with the Run Processor consist of starting the model, running a batch job, and viewing the calculation engine and results.

Starting the Model

The model is started by opening the SGIPce workbook. The worksheet presented when the workbook opens is used to define all aspects of the run. On this sheet the user defines the name of the run and the manner in which they would like the system to run (e.g., should it save all the Calculation Engines, should it update and replace results, etc.).

In the Technology Definitions table, the user selects from the complete *List of Technologies* the set of technologies they wish to include in the current run. To assist in managing the technology list, there are a set of buttons to help clear and set flags and to reset data values that can be changed by the user from previous runs. Every possible combination of technology, utility, climate region, etc., is defined in this table. The user simply sets the *Run Technology Flag* to *Yes* and the line item will be included in the run. With all desired items selected and all controls appropriately set, the user can move to the next step of running a batch job.

Running a Batch Job

With the current run defined, there are three buttons available for starting the batch process. Essentially, all three buttons produce the same end result. The buttons are designed to give the user options in what they see while the batch run is executing. For example, if the user wants constant feedback during a run then they would use the *Batch Process View Screen Updating* button. If the user wants the run to go quickly and completely deal with the housekeeping of the workbooks then the *Batch Process No Screen Updating* button would be pressed. All three buttons lead to the same set of results being produced; the different types of batch runs simply impact the time to completion and the visual representation to the viewer while the process is running.

Implementing a batch run starts a process of opening workbooks, copying data, pasting data, running the model, and saving the results. The code underlying the SGIPce model is written in Visual Basic for Applications and can be viewed in the Visual Basic editor included as part of Excel.

Viewing Calculation Engine and Results

If the user chooses to Save Calc for each line, upon completion of the run, the Calculation Engine and the Results from each run are stored in the appropriate workbook(s). If the user chose to not Save Calc for each line, upon completion of the run, the results from each run will not be stored and the



Calculation Engines will not be created. If the user answers yes to the query “Store Results by Utility?,” the results will be segregated by utility with a separate Results workbook being created for each utility defined in the run. If this option is not chosen, only one Results workbook is created to hold all the results from the batch run.

All Results workbooks are stored in the sub-directory named Results just below the SGIPce workbook. The user has the option to store the workbooks in other locations if they choose. They may rename the workbooks if so desired. The only way this is made available to the user, however, is when the Batch Process View Screen Updating button is pressed. The other two run buttons automatically save the results workbooks with their default names.

There is a control named Update/Replace Results on the opening screen in SGIPce. The purpose of this control is to tell the model to either completely replace any currently saved results with the new ones being run (No) or to update or replace results that currently exist (Yes). If set to No, then the Results workbook is overwritten with a new one. If this control is set to Yes, however, the model treats results much differently. First the model looks to see if a Results workbook already exists with the same name as defined by the user for this run. If it does, then the model opens that workbook as the data store for the current run. If it does not, then it creates a new workbook for results. As the batch process proceeds and results are ready to be stored, the model looks in the Results workbook for previously stored results. If they exist, then they are replaced. If they do not exist, then they are added as a new worksheet. No results worksheets are deleted from the Results workbook when this flag is set. This feature can be used to fix existing results without the need of running the entire list of technologies and new technologies may be added again without the need of running the entire list of technologies as well.

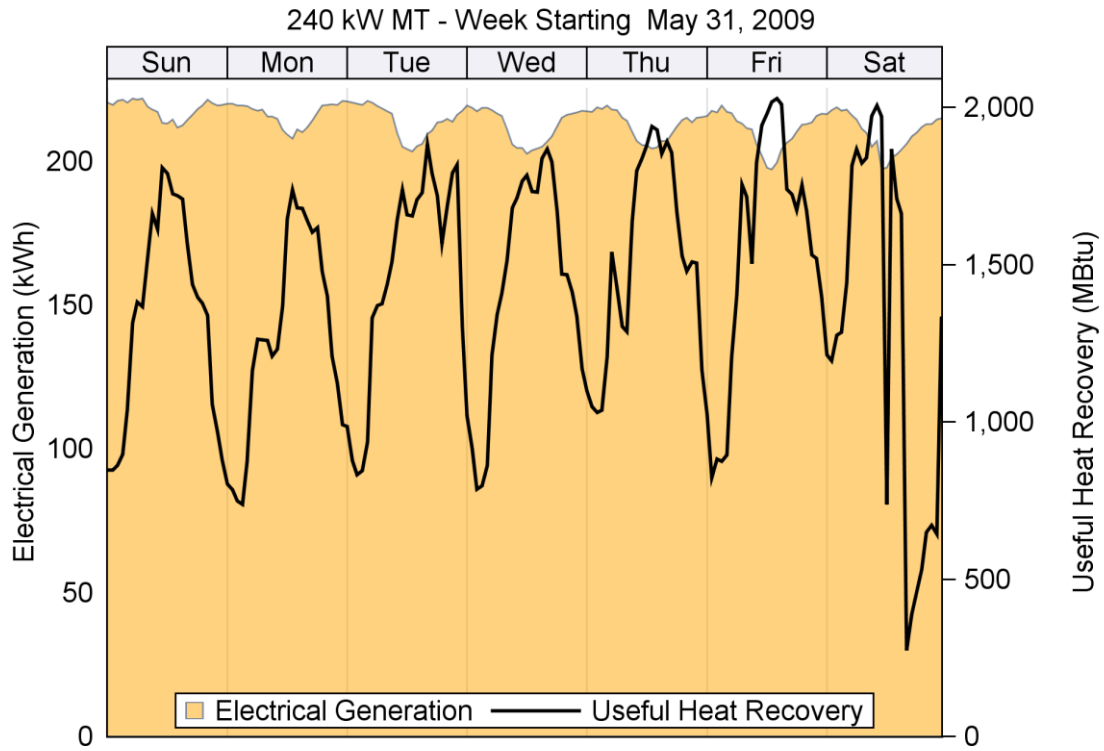
The Importance of Hourly Profiles

Electric utility tariffs reflect the different cost of generating and transferring electricity at various times of the day and year. During peak demand, electricity is more costly to generate and transfer than during off-peak hours. When valuing electricity displaced by SGIP technologies, it is important to take into account the time period when it is displaced. We do this using representative SGIP generation and useful waste heat recovery profiles that are synchronized against electricity and gas tariffs. We develop representative electricity generation and useful waste heat recovery profiles from SGIP metered performance data as well as values from literature. The figure below is an example of the variability in electricity production and waste heat recovery for a 240 kW microturbine operating as a CHP system. Within the model, we develop representative profiles for each technology over 8,760 hours of operation per year. These representative profiles are hourly generation profiles created for each of the technologies. The profiles can represent step-function shaped load profiles, flat base load profiles, or load-following type profiles with a single peak or load-following multi-peak profiles that are



representative of the particular SGIP technology. The profiles also vary by inland or coastal climate region.⁷

FIGURE 5-5: REPRESENTATIVE ELECTRICITY GENERATION AND WASTE HEAT RECOVERY PROFILES



⁷ The production profiles are located in the technology input workbooks under the tab “ProductionCurves.”

6 SGIP COST EFFECTIVENESS RESULTS

A primary purpose of this study is to assess cost effectiveness of distributed generation and storage technologies being deployed under the SGIP. The developed cost effectiveness framework allows SGIP technologies to be compared one against another as possible resources. The framework also enables evaluation of the cost effectiveness of a portfolio of distributed generation and storage technologies. The SGIP represents one such portfolio of these technologies.

Whether evaluating the cost effectiveness of a single distributed generation or storage technology or a portfolio of distributed generation and storage technologies, we use cost tests developed in accordance with CPUC Decision 09-08-026.¹ That decision outlined an approach for modifying cost tests contained in the Standard Practice Manual (SPM)² and used in evaluating energy efficiency measures to distributed generation technologies. We further extend the modified approach to include advanced energy storage technologies.

Cost effectiveness is typically examined from four perspectives: participants (Participant Cost Test), utilities (Program Administrator Cost Test), the combined perspective of participants and non-participants (Total Resource Cost Test), and society at large (Societal Total Resource Cost Test).³

The TRC test measures the net costs and benefits of a program that accrue to all of the utility's customers, both participants and non-participants. The TRC test examines the value of the program as another way to achieve certain utility or policy goals.

The Total Resource Cost (TRC) test treats the program of measures as a series of resource options. The test measures the net benefits and costs of a program and/or measure that accrue to all utility customers, both participants and non-participants. The TRC benefits are largely the avoided electric and gas costs, but include federal tax benefits or credits. The TRC costs are the costs associated with program administration, the customer measures, and increased operating costs. The TRC does not include the cost of incentives. The TRC test examines the value of the program as another way to achieve certain utility or policy goals. A positive TRC or a TRC ratio greater than 1.0 indicates that the program or measure is estimated to produce a net benefit in the utility territory over the life of the measure.

¹ D-09-08-026, Decision for Adopting Cost-Benefit Methodology for Distributed Generation, CPUC, August 20, 2009

² California Public Utilities Commission, *California Standard Practice Manual: Economic Analysis of Demand-Side Programs and Projects*, 2001, from http://www.cpuc.ca.gov/NR/rdonlyres/004ABF9D-027C-4BE1-9AE1-CE56ADF8DADC/0/CPUC_STANDARD_PRACTICE_MANUAL.pdf

³ For this report, the Total Resource Cost Test (TRC) and the Societal Total Resource Cost (STRC) Test are calculated using similar inputs except for the discount rate applied to future benefits and costs. The TRC uses the utility's discount rate while the STRC uses a lower, societal discount rate.



The societal version of the Total Resource Cost (STRC) test looks at the overall cost effectiveness of SGIP technologies to society at large. The societal test is similar to the TRC except it uses the societal discount rate (a lower discount rate than the utility discount rate used in the TRC).⁴ If the ratio of the STRC benefits-to-costs exceeds 1.0, the benefits to society exceed the costs in implementing the SGIP technology.

Note that the TRC and STRC provide very similar results in this analysis. In California, both the STRC and TRC tests take into account monetary values for emissions.⁵ The only difference between the STRC and TRC is the discount rate used in the tests.⁶ While the model generates results for both the TRC and STRC, we focus primarily on STRC results. This has been done so as to remain consistent with the methodology used in the 2011 SGIP cost effectiveness report.

The Participant Cost test (PCT) examines the cost effectiveness of the SGIP technology to the participant. Examples of participant benefits include electricity and gas bill savings, favorable tax treatment, or new revenue streams including utility rebates. Participant costs include increased capital outlay associated with the technology, increased operating and maintenance (O&M) costs, and fueling costs. If the benefits outweigh the costs, the technology is considered cost effective to the participant.

The Program Administrator Cost (PAC) test examines the cost effectiveness of SGIP technologies from the utility perspective.⁷ It compares the net costs of participant projects (i.e., the PA costs and incentives) to other supply-side resource options available to the utility. It takes into account the costs incurred by the PAs (including incentive costs) and excludes participant costs. The PAC represents the utility's perspective on the net value of implementing the portfolio of projects making up the SGIP.

6.1 OVERALL SUMMARY OF RESULTS

By combining societal and participant perspectives about the cost effectiveness of SGIP technologies, we gain valuable insights on which technologies should be provided incentives. Ideally, public purpose incentive programs like the SGIP should target incentives to those technologies that deliver high value to society but require near term financial assistance to help overcome near term market barriers.

From a strictly mathematical perspective, a benefit-to-cost ratio of 1.0 represents a threshold that a technology must exceed to be considered cost effective. However, cost effectiveness analyses have inherent uncertainties in their results. For example, an SGIP technology that appears to be cost effective

⁴ Neither the TRC nor the STRC includes utility incentives as a benefit or a cost. From society's point of view, a rebate is a transfer from one person to another and, therefore, does not change society's benefits or costs.

⁵ The monetary values for emissions are derived from the E3 Avoided Cost Model dated May, 21 2015. The cost of carbon in this model is based on CO₂ prices from the 2014-2030 CPUC MPR Forecast. In 2014, the CO₂ price is \$22.50/ton, increasing to \$36.97/ton in 2020. The NO_x price is \$6.40/lb in 2014 and \$12.47/lb in 2020.

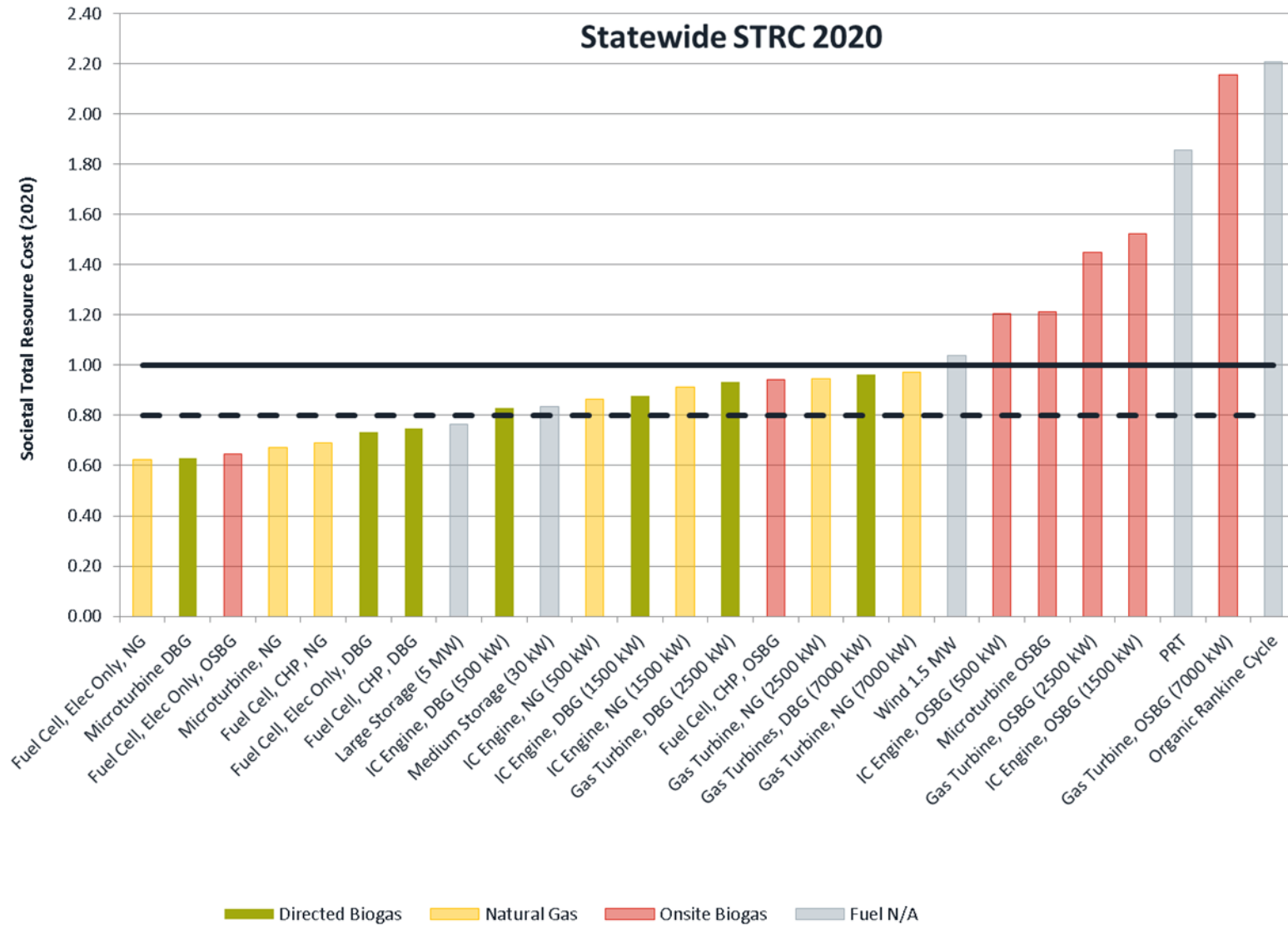
⁶ The discount rate used in the STRC is 5% and in the TRC is 7.5%.

⁷ The study does not provide cost effectiveness results for Southern California Gas Company (SCG) even though SCG is very active in the SGIP. Due to the way in which core and non-core gas costs and prices are handled in the model, it is not possible to generate comparable gas-based cost effectiveness results for SCG.



to participants under this evaluation may face real market risks that are difficult to monetize and have not been modeled for this analysis. In addition, SGIP technologies may provide additional benefits to society that have not been monetized or modeled in this analysis. Consequently, strategies for providing incentives also need to take into account market risks and uncertainties.

A first step is to examine SGIP technology cost effectiveness to society. Figure 6-1 is a summary of the STRC test results for all the commercial SGIP technologies at 2020. While STRC results are available for all years from 2014 through 2024, the future year of 2020 is selected for two reasons. First, 2020 represents the currently planned end date of the SGIP. It is important to know the status of SGIP technology cost effectiveness to society at the planned end of the program. Second, 2020 also represents six years of change in the SGIP technologies and the marketplace, thereby allowing time for improvements that could help increase the cost effectiveness of the technologies to society.

FIGURE 6-1: STATEWIDE STRC TEST RESULTS FOR SGIP TECHNOLOGIES AT 2020 (NO INCENTIVE)




SGIP technologies in Figure 6-1 have been arranged from lowest to highest benefit-to-cost STRC ratio. In addition, a solid horizontal black line in the chart shows the mathematical STRC threshold of 1.0. A dotted line corresponding to an STRC benefit-to-cost ratio has also been added to the chart. This dotted line represents a lower threshold which allows for the uncertainties associated with difficult to monetize societal benefits and market risks.⁸

Review of Figure 6-1 shows the following:

- » Nearly all (18 out of 26) of the evaluated SGIP technologies pass the lower STRC benefit-cost ratio of 0.8 by 2020.
- » SGIP technologies with an STRC benefit-cost ratio less than 0.8 in 2020 include microturbines fueled by natural gas or directed biogas, fuel cells with CHP capabilities fueled by natural gas or directed biogas, the electric-only fuel cells regardless of the fuel source; and the large storage (5 MW) technology.
- » Eight of the evaluated SGIP technologies had STRC benefit-cost ratios greater than 1.0. Factors that contribute to these high STRC benefit-cost ratios include no fueling costs, favorable tax treatment, and additional revenue streams (e.g., Renewable Energy Credits).

Additional details on the STRC results are provided later in this section.

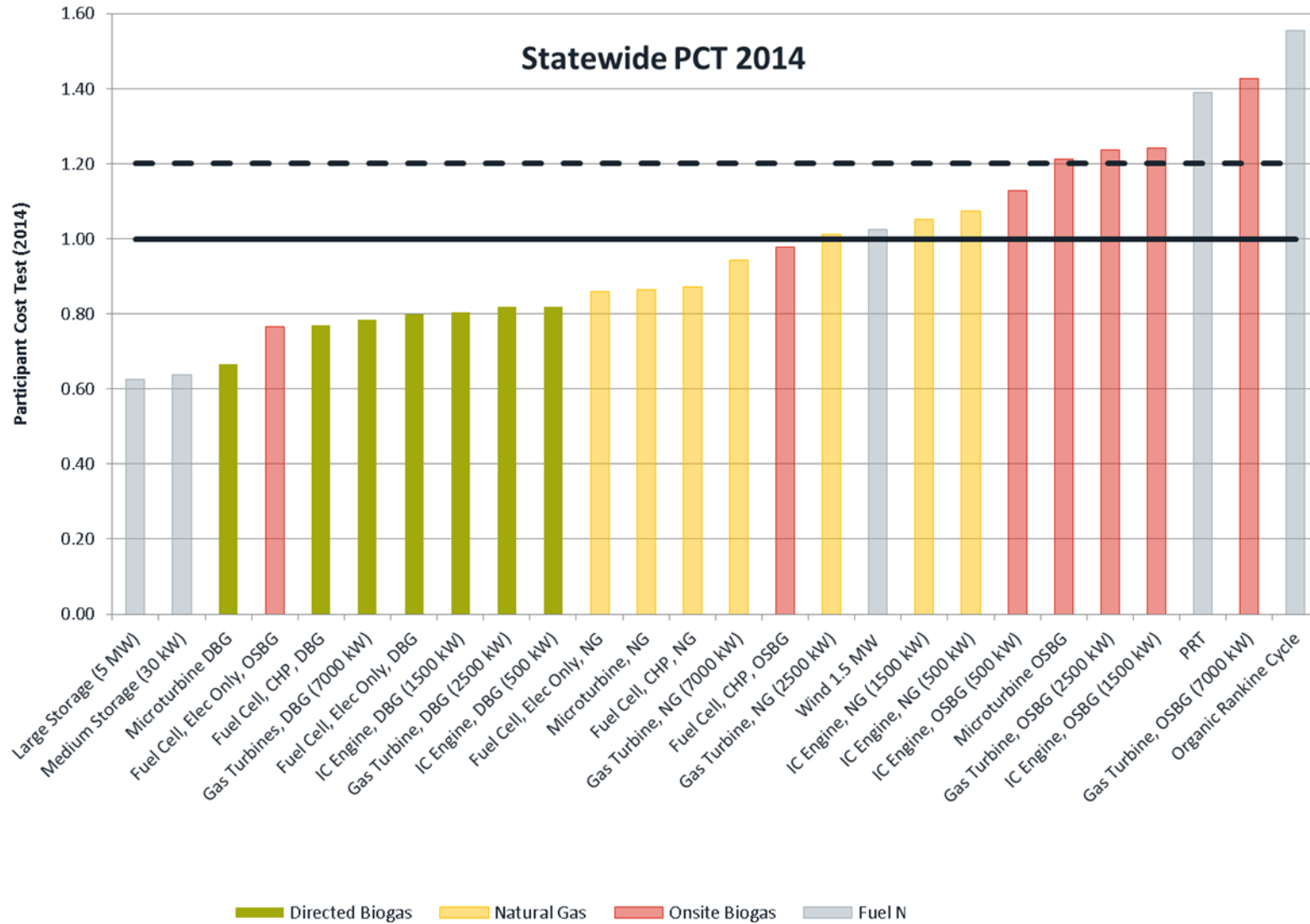
All of the SGIP technologies shown in Figure 6-1 that have STRC ratios equal to or greater than 0.8 are technologies that can be viewed as potentially providing high value to society by 2020. The next step is to identify those SGIP technologies that are not currently cost effective to participants and, therefore, could benefit from incentives to help overcome market risks and barriers.

Figure 6-2 is a summary of the PCT results at 2014 for all the evaluated commercial sector SGIP technologies. Similar to the 2020 STRC results, a solid horizontal line shows the mathematical benefit-to-cost threshold of 1.0. However, instead of a dotted line located across the chart at a benefit-to-cost ratio of 0.8, this time the dotted line is located at a benefit-to-cost ratio of 1.2. This higher benefit-to-cost ratio reflects that the uncertainty in the PCT results from the model may mask market risks borne by participants. Consequently, SGIP technologies showing 2014 PCT benefit-to-cost ratios equal to or less than 1.2 may not actually be cost effective to participants due to market risks or barriers that cannot be well monetized.

⁸ High uncertainty bounds are not unheard of in cost effectiveness analysis. For example, the *2008 California Statewide Potential Study* used a TRC test of 85% to determine eligibility for program rebates. In general, the uncertainty of energy efficiency measures may be less than the uncertainty of DER technologies due to the shorter expected useful life of energy efficiency measures when compared to DER measures.



FIGURE 6-2: STATEWIDE PCT RESULTS FOR SGIP TECHNOLOGIES AT 2014 (NO INCENTIVE)





Review of the PCT results in Figure 6-2 shows the following:

- » All but six of the SGIP technologies have 2014 PCT benefit-cost ratios less than or equal to 1.2. The technologies that had PCT benefit-cost ratios greater than 1.2 include:
 - > Certain SGIP technologies fueled by onsite biogas, including the 200 kW microturbine, both the 2.5 MW and 7 MW gas turbines, and the 1.5 MW IC engine.
 - > Both PRT and ORC technologies, which have no fueling costs.
- » SGIP technologies showing the highest PCT benefit-cost ratios are those without fueling costs. With the exception of the electric-only fuel cells, this includes all SGIP technologies fueled by onsite biogas, wind energy systems, and PRT and ORC technologies.

Additional details on the PCT results are provided later in this section.

Another valuable step is to examine the cross section of SGIP technologies that potentially provide high benefits to society in 2020 and which in 2014 may not be cost effective to participants.

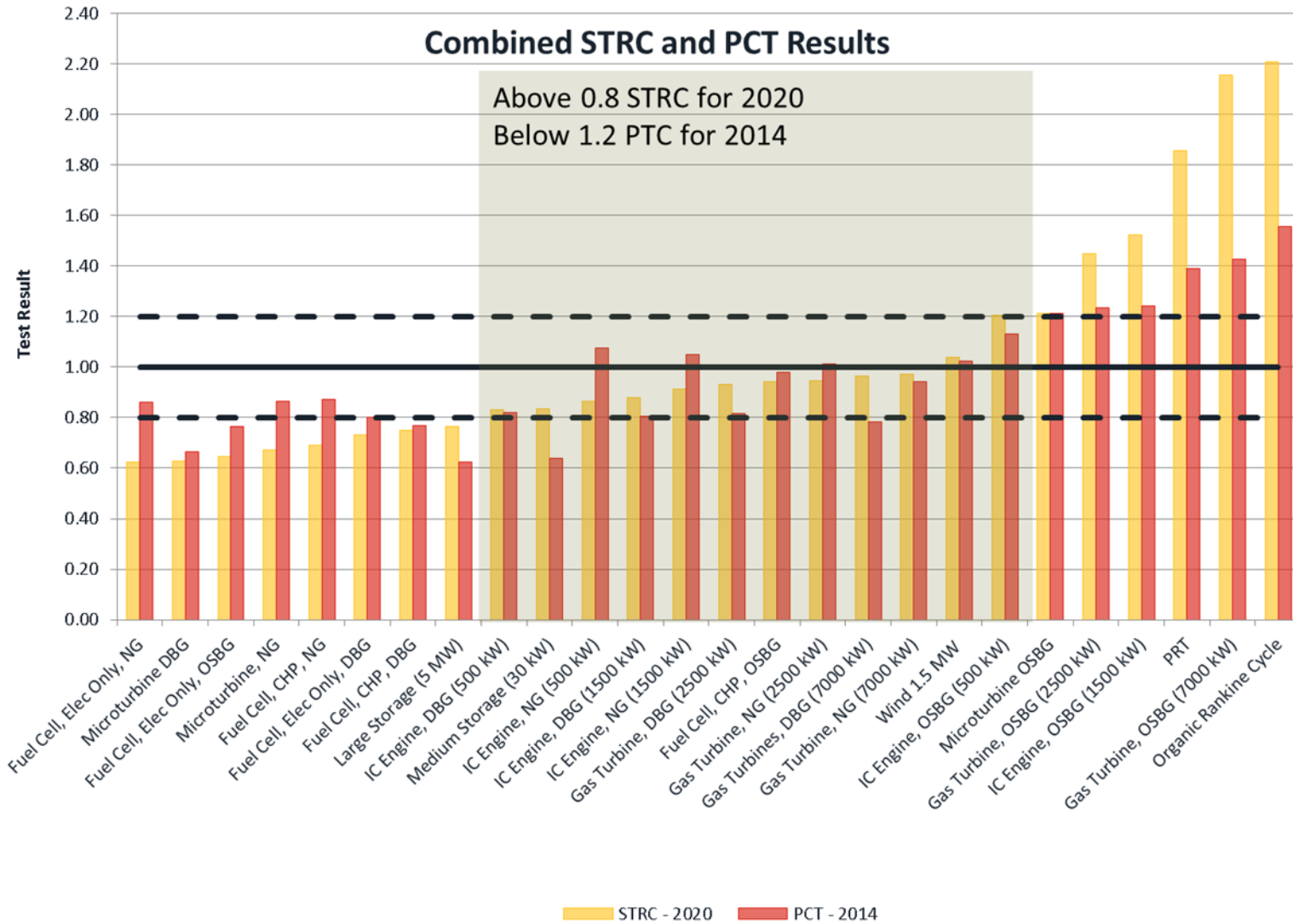
Figure 6-3 shows the combined 2020 STRC results and the 2014 PCT results for the evaluated commercial sector SGIP technologies. A grey border identifies those SGIP technologies with 2020 STRC benefit-to-cost ratios equal to or greater than 0.8 and which also have 2014 PCT benefit-to-cost ratios equal to or greater than 1.2. This subset of SGIP technologies represent technologies that should ideally be targeted to receiving incentives: having both potentially high societal value in 2020 and facing market barriers in 2014 that may prevent them from achieving those high societal benefits.

SGIP technologies that fall into this subset include:

- » The 500 kW IC engines regardless if fueled by natural gas, directed biogas, or onsite biogas; and the 1.5 MW IC engines fueled by natural gas or directed biogas.
- » Both the 2.5 MW and 7 MW gas turbine, if fueled by natural gas, or directed biogas.
- » The 500 kW CHP fuel cell fueled by onsite biogas.
- » The 30 kW AES and the 1.5 MW wind energy technologies.



FIGURE 6-3: COMBINED 2020 STRC AND 2014 PCT RESULTS (NO INCENTIVE)





The following sections present the individual STRC, PCT and PAC test results. Results for the STRC and PCT are presented first at the statewide level, then by groups of SGIP technologies and then by individual technologies. The order of discussion is as follows:

- » STRC results: pg. 6-10
 - > Statewide STRC results: pg. 6-11
 - > STRC results grouped by technology and category
 - Non-Fuel Technologies (includes wind, AES, PRT, etc.): pg. 6-14
 - AES: pg. 6-17
 - Wind: pg. 6-20
 - PRT: pg. 6-22
 - Waste Heat to Power: pg. 6-23
 - Natural Gas Fueled Technologies: p.6-24
 - Fuel Cells: pg. 6-28
 - Gas Turbines: pg. 6-30
 - IC Engines: pg. 6-33
 - Microturbines: pg. 6-34
 - Directed Biogas Fueled Technologies: pg. 6-35
 - Fuel Cells: pg. 6-36
 - Gas Turbines: pg. 6-39
 - IC Engines: pg. 6-41
 - Microturbines: pg. 6-43
 - Onsite Biogas Fueled Technologies: pg. 6-44
 - Fuel Cells: pg. 6-48
 - Gas Turbines: pg. 6-50
 - IC Engines: pg. 6-52
 - Microturbines: pg. 6-54
- » PCT results: pg. 6-55
 - > Statewide PCT results: pg. 6-55
 - > PCT results grouped by technology and category
 - Non-Fuel Technologies (includes wind, AES, PRT, etc.): pg. 6-58
 - AES: pg. 6-59
 - Wind: pg. 6-66
 - PRT: pg. 6-69
 - Waste Heat to Power: pg. 6-71
 - Natural Gas Fueled Technologies: p.6-73
 - Fuel Cells: pg. 6-73
 - Gas Turbines: pg. 6-79



- IC Engines: pg. 6-82
- Microturbines: pg. 6-86
- Directed Biogas Fueled Technologies: pg. 6-88
 - Fuel Cells: pg. 6-88
 - Gas Turbines: pg. 6-92
 - IC Engines: pg. 6-96
 - Microturbines: pg. 6-99
- Onsite Biogas Fueled Technologies:
 - Fuel Cells: results covered in directed biogas section
 - Gas Turbines: results covered in directed biogas section
 - IC Engines: pg. 6-101
 - Microturbines: pg. 6-105
- Summary of MIRR Results: pg. 6-107
- » PAC results: pg. 6-108

The SGIPce model generates test results for every IOU, market segment and two climate zones (inland and coastal). However, presenting results for every IOU, market segment and climate zone represents an overwhelming amount of information. Instead, we have chosen to provide “representative” results for one IOU (PG&E), one market segment (commercial) and one climate zone (inland). Consequently, except at the statewide level, the following results are provided only for PG&E, commercial sector and inland climate zone.⁹

6.2 SOCIETAL COST TEST RESULTS

The STRC test looks at the cost effectiveness of SGIP technologies from society’s point of view. The STRC is an important tool for assessing the overall value of an SGIP technology or portfolio of projects to society as a whole. From a policy perspective, it may be important in an incentive program to target support for technologies that are currently not cost effective to participants (without incentives) but reflect high benefits to society in the future. Incentives provided to these technologies ideally enable them to get a foothold in the marketplace so they can grow and provide high societal benefits in the future.

The SGIPce model generates STRC results for all the examined SGIP technologies from 2014 through 2034. However, the STRC results for two years during this time period are of particular importance: the current year (identified as 2014) and the year at which the SGIP is set to expire (2020). Examining the

⁹ The commercial sector was selected because most of SGIP’s rebated capacity to date occurs in the commercial sector. Inland climate was selected because of the importance of peak demand effects, which are more closely tied to “hot inland” conditions rather than the cooler conditions associate with coastal environments. PG&E was selected primarily to remain consistent with the 2011 cost effectiveness study (which used PG&E results) but also because results between PG&E and SCE are expected to be fairly similar.



cost effectiveness at “current” and “end date” years provides observations about the overall change in cost effectiveness of technologies in the program.

Statewide Results

Table 6-1 is a summary of the combined IOU-specific and statewide STRC results for 2014 and 2020 by the SGIP technologies deployed in the commercial sector. SGIPce generates STRC results not only by each evaluated SGIP technology but also by electric IOU territory, sector (e.g., commercial, residential, or government/non-profit) and geographical region (“coastal” and “inland”). The statewide results in Table 6-1 represent averages across IOU service territories for California’s three largest electric IOUs. The results are averaged in two different ways. First, the results are averaged arithmetically (weighted equally) among the three electric IOUs. Second, the STRC results are averaged based on 2014 and projected 2020 electricity sales among the three electric utilities. Note that the results in Table 6-1 reflect only the commercial sector as this sector constitutes the bulk of the SGIP project installations on a capacity basis; results for the residential and non-profit/governmental sectors are provided in Appendix C.



TABLE 6-1: STATEWIDE SUMMARY OF COMMERCIAL SECTOR STRC RESULTS FOR 2014 AND 2020 (NO INCENTIVES)

Technology	SGIPce System Size (kW)	PG&E		SCE		SDG&E		Statewide Equal		Statewide Elec Sales	
		STRC 2014	STRC 2020	STRC 2014	STRC 2020	STRC 2014	STRC 2020	STRC 2014	STRC 2020	STRC 2014	STRC 2020
Wind Turbine											
1.5 MW	1,500	1.02	1.08	0.96	1.00	0.97	1.02	0.98	1.03	0.99	1.04
Fuel Cell - Electric Only											
Natural gas	500	0.67	0.63	0.65	0.61	0.67	0.64	0.67	0.63	0.66	0.62
Onsite biogas	500	0.64	0.65	0.63	0.64	0.64	0.65	0.64	0.65	0.64	0.65
Directed biogas	500	0.77	0.74	0.75	0.72	0.77	0.74	0.76	0.74	0.76	0.73
Fuel Cell - CHP (i.e., w/waste heat recovery)											
Natural gas powered	1,200	0.72	0.70	0.70	0.68	0.73	0.71	0.71	0.70	0.71	0.69
Onsite biogas	1,200	0.90	0.96	0.86	0.92	0.89	0.95	0.88	0.94	0.88	0.94
Directed biogas	1,200	0.79	0.76	0.76	0.73	0.79	0.76	0.78	0.75	0.78	0.75
Gas Turbine - CHP											
Natural gas powered (2500 kW)	2,500	0.99	0.97	0.94	0.91	0.98	0.96	0.97	0.95	0.97	0.94
Onsite biogas (2500 kW)	2,500	1.37	1.49	1.30	1.40	1.34	1.46	1.34	1.45	1.33	1.45
Directed biogas (2500 kW)	2,500	1.02	0.97	0.95	0.89	0.99	0.93	0.99	0.93	0.98	0.93
Natural gas powered (7000 kW)	7,000	1.06	1.04	0.94	0.91	0.97	0.93	0.99	0.96	1.00	0.97
Onsite biogas (7000 kW)	7,000	2.10	2.38	1.77	1.96	1.83	2.03	1.90	2.12	1.93	2.16
Directed biogas (7000 kW)	7,000	1.09	1.05	0.96	0.89	0.98	0.92	1.01	0.95	1.02	0.96
Microturbine - CHP											
Natural gas powered (200 kW)	200	0.67	0.67	0.67	0.67	0.70	0.70	0.68	0.68	0.68	0.67
Onsite biogas (200 kW)	200	1.09	1.22	1.07	1.20	1.09	1.22	1.08	1.21	1.08	1.21

Technology	SGIPce System Size (kW)	PG&E		SCE		SDG&E		Statewide Equal		Statewide Elec Sales	
		STRC 2014	STRC 2020	STRC 2014	STRC 2020	STRC 2014	STRC 2020	STRC 2014	STRC 2020	STRC 2014	STRC 2020
Directed biogas (200 kW)	200	0.68	0.64	0.67	0.62	0.69	0.64	0.68	0.63	0.68	0.63
IC Engine - CHP											
Natural gas powered (500 kW)	500	0.88	0.87	0.86	0.85	0.90	0.89	0.88	0.87	0.87	0.86
Onsite biogas (500 kW)	500	1.04	1.22	1.02	1.19	1.04	1.22	1.03	1.21	1.03	1.21
Directed biogas (500 kW)	500	0.88	0.84	0.86	0.81	0.89	0.85	0.88	0.83	0.87	0.83
Natural gas powered (1500 kW)	1,500	0.94	0.93	0.91	0.89	0.95	0.94	0.93	0.92	0.93	0.91
Onsite biogas (1500 kW)	1,500	1.26	1.55	1.22	1.49	1.27	1.55	1.25	1.53	1.25	1.52
Directed biogas (1500 kW)	1,500	0.95	0.90	0.91	0.85	0.95	0.89	0.93	0.88	0.93	0.88
Organic Rankine Cycle											
500 kW	500	2.14	2.24	2.08	2.17	2.14	2.24	2.12	2.22	2.11	2.21
Storage											
Med storage (30 kW)	30	0.62	0.89	0.56	0.79	0.59	0.83	0.59	0.83	0.59	0.83
Larger storage (5000 kW)	5,000	0.60	0.82	0.54	0.71	0.58	0.78	0.57	0.77	0.57	0.77
PRT											
400 kW	400	1.79	1.88	1.75	1.83	1.80	1.88	1.78	1.86	1.77	1.85



As shown Table 6-1 a significant number of SGIP technologies have STRC benefit-to-cost ratios close to or exceeding 1.0 at either 2014 or 2020. Exceptions include fuel cells-electric only; medium or large storage; microturbines fueled by natural gas or directed biogas; and IC engines in the 500 kW size range fueled by natural gas or directed biogas.

In order to better understand the STRC results, it is helpful to consider the results grouped by combinations of technologies and fuels. Generally, fuel types can be grouped by the following four categories:

- » Non-fuel technologies (e.g., wind, storage, etc.)
- » Natural gas-fueled technologies
- » Directed biogas-fueled technologies
- » Onsite biogas-fueled technologies

Non-Fuel Technologies

Non-fuel technologies represent SGIP systems that do not purchase fuel.¹⁰ They consist of wind energy systems, advanced energy storage, pressure reduction turbines and waste heat to power systems.

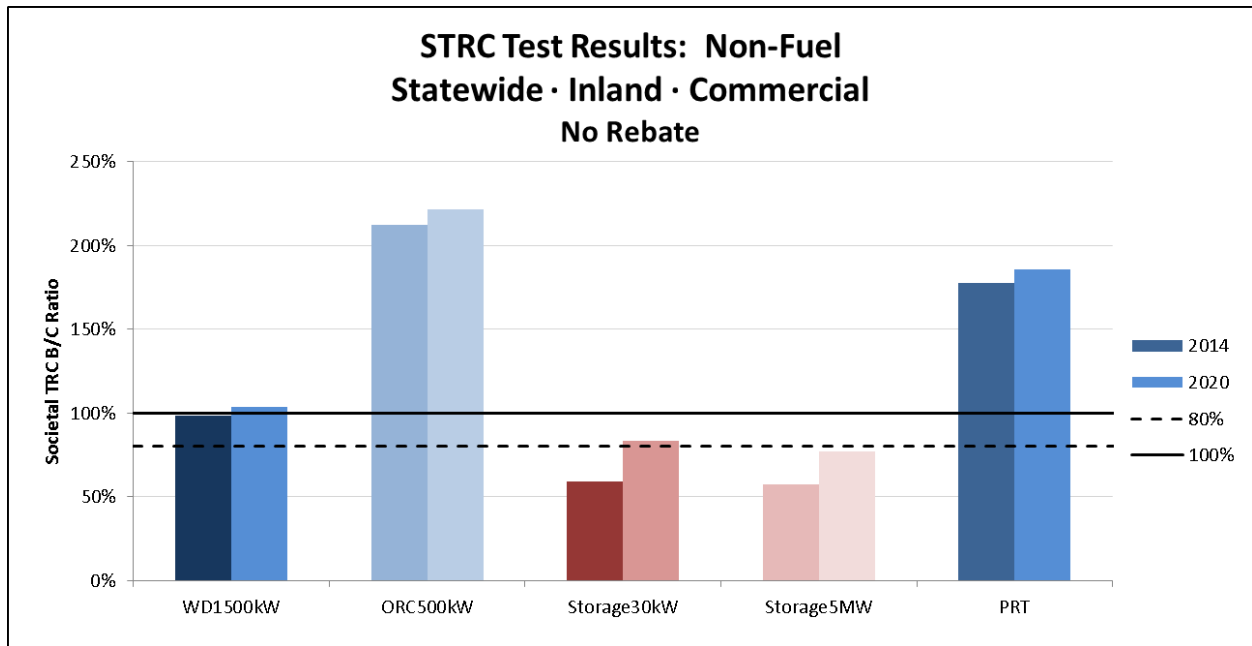
Figure 6-4 shows the statewide STRC results for non-fuel SGIP technologies in 2014 and 2020 without incentives.¹¹ The darker bars reflect the STRC results for non-combustion technologies at 2014, while the lighter bars are the STRC results in 2020. The solid horizontal line on the chart (at an STRC benefit-to-cost ratio value of 1) represents the threshold typically used for determining if the measure passes the STRC test. However, as noted in the beginning of this section, the STRC results include some uncertainty. Consequently, a dotted horizontal line is drawn at a benefit-to-cost ratio of 0.8 to indicate the STRC results against a lower threshold. The large uncertainty bound is due in part to the relatively high uncertainty associated with utility rate and avoided cost forecasts. In general, SGIP technologies are long-lived measures, necessitating a 20-year rate and avoided cost forecast from the year of the measure's installation. Changes in the availability of resources, the valuation of greenhouse gases (GHG), and macroeconomic outcomes (recessions and expansions) can have significant impacts on electricity rates and avoided costs in the future.

¹⁰ Stand-alone energy storage systems are charged with electricity from the grid. While these storage systems incur "charging" costs, we group storage technologies under the non-fuel technology classification.

¹¹ STRC results are only shown for the commercial sector and for the representative "inland" climate zone.



FIGURE 6-4: STATEWIDE STRC RESULTS BY NON-FUEL TECHNOLOGIES (2014 AND 2020), NO INCENTIVES



The Organic Rankine Cycle (ORC) and pressure reduction turbine (PRT) technologies have STRC benefit-cost ratios that exceed 1.0 both in 2014 and 2020 by significant margins. Wind (at 1.5 MW) has a 2014 STRC benefit-to-cost ratio just below 1.0 and a 2020 STRC benefit-to-cost ratio just over 1.0. Both the 30 kW and 5 MW advanced energy storage technologies have STRC benefit-cost ratios in 2014 significantly below 1.0. Note that the larger 5 MW advanced energy storage system has a STRC benefit-to-cost ratio which increases and is just above 1.0 in 2020. It is helpful to look at specific cost and benefit components to better understand these results.

Table 6-2 provides the estimated cost and benefit components making up the 2014 STRC results for the representative pressure reduction turbine (400 kW), advanced energy storage (both at 30 kW and 5 MW), wind (1.5 MW) and ORC (500 kW) technologies. Note that the system costs reported in Table 6-2 are the levelized system costs spread out over the expected lifetime of the technology and not the total system costs. Also, note that the emission benefits associated with avoiding electricity produced at a central power plant (by using electricity produced from SGIP technologies) is included in the avoided cost benefits.



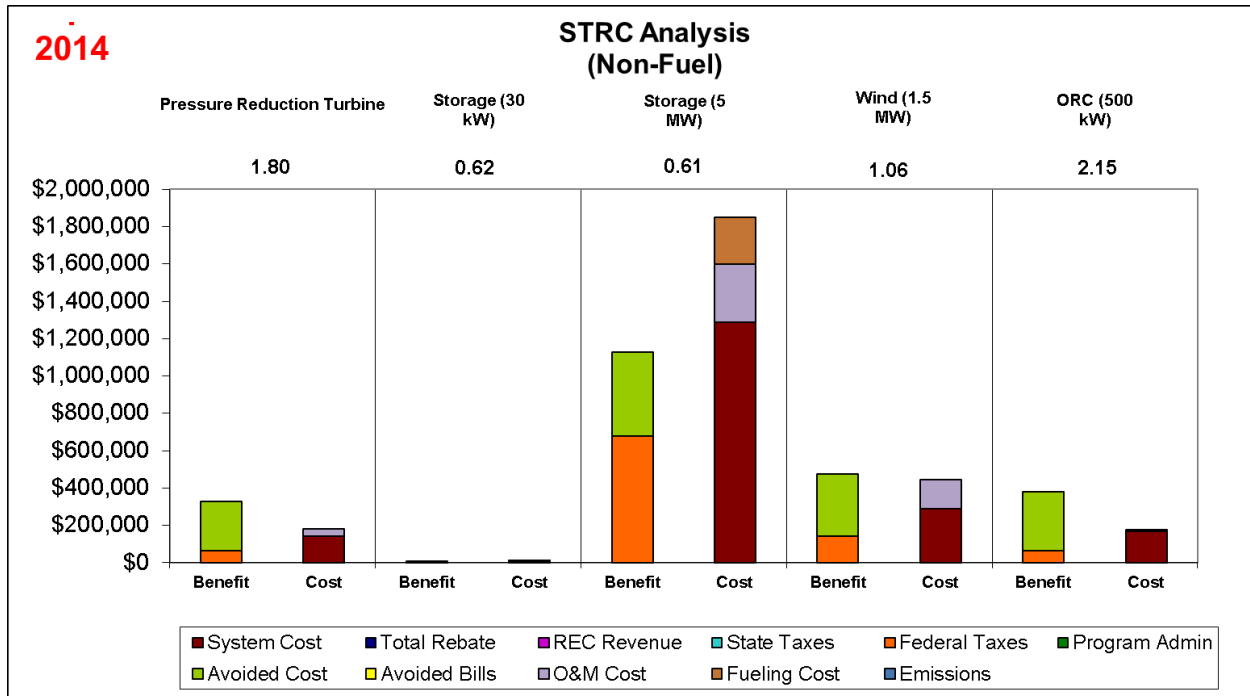
TABLE 6-2: STRC TEST LEVELIZED COST AND BENEFITS FOR NON-COMBUSTIBLE SGIP TECHNOLOGIES, PG&E TERRITORY, NO REBATE, 2014

Cost Test	Pressure Reduction Turbine		Storage (30 kW)		Storage (5 MW)		Wind (1.5 MW)		ORC (500 kW)	
	STRC		STRC		STRC		STRC		STRC	
2014 Results	Benefit\$	Cost\$	Benefit\$	Cost\$	Benefit\$	Cost\$	Benefit\$	Cost\$	Benefit\$	Cost\$
System Cost	--	140,544	--	8,241	--	1,288,120	--	289,800	--	166,576
Total Rebate	--	--	--	--	--	--	--	--	--	--
REC Revenue	--	--	--	--	--	--	--	--	--	--
State Taxes	--	--	--	--	--	--	--	--	--	--
Federal Taxes	66,261	--	3,831	--	678,172	--	143,403	--	64,781	--
Program Admin	--	--	--	--	--	--	--	--	--	--
Avoided Cost	263,111	--	2,671	--	447,598	--	331,682	--	314,040	--
Avoided Bills	--	--	--	--	--	--	--	--	--	--
O&M Cost	--	42,124	--	982	--	309,259	--	157,143	--	9,543
Fueling Cost	--	--	--	1,252	--	252,168	--	--	--	--
Emissions	--	--	--	--	--	--	--	--	--	--
Standby Charges	--	--	--	--	--	--	--	--	--	--
Total	329,372	182,667	6,502	10,475	1,125,770	1,849,546	475,085	446,943	378,821	176,119
Net Benefit		146,705		(3,973)		(723,776)		28,142		202,702
Ratio		1.80		0.62		0.61		1.06		2.15



Figure 6-5 provides a visual depiction of the STRC costs and benefit components for the different non-fuel SGIP technologies at 2014.

FIGURE 6-5: STRC LEVELIZED COST AND BENEFIT COMPONENTS FOR NON-FUEL SGIP TECHNOLOGIES, PG&E TERRITORY, NO INCENTIVE, 2014



In looking at the breakdown of costs and benefits presented in Table 6-2 and Figure 6-5, it is apparent that the annual avoided costs for PRT and ORC significantly exceed the levelized system costs. In contrast, the system costs for the 30 kW and the 5 MW advanced energy storage systems exceed the avoided costs by approximately a factor of three. In addition, storage must pay charging costs while the PRT, ORC and wind systems receive their power from free sources.

A closer look at specific technologies is helpful in understanding nuances of the STRC results.

ADVANCED ENERGY STORAGE

We evaluated three representative sizes of storage systems: a residential 5 kW lithium ion system, a small commercial 30 kW lithium ion system that could be used in a variety of commercial settings, and a 5 MW flow through battery system that could be used at large commercial or industrial settings. A 30 kW size was selected since the same costs could represent a system slightly smaller that would receive a lump sum incentive or a 30 kW system that would receive the hybrid PBI incentive.

Storage is unique amongst SGIP technologies in that in addition to a rated power (kW) capacity, systems have a rated energy (kWh) capacity. The smaller 5 kW and 30 kW systems are modeled with 10 kWh and 60 kWh of energy capacity, respectively, giving them enough energy to meet the rated power for 2 hours per SGIP program rules. These systems are simulated to discharge for nearly 2 hours at the rated



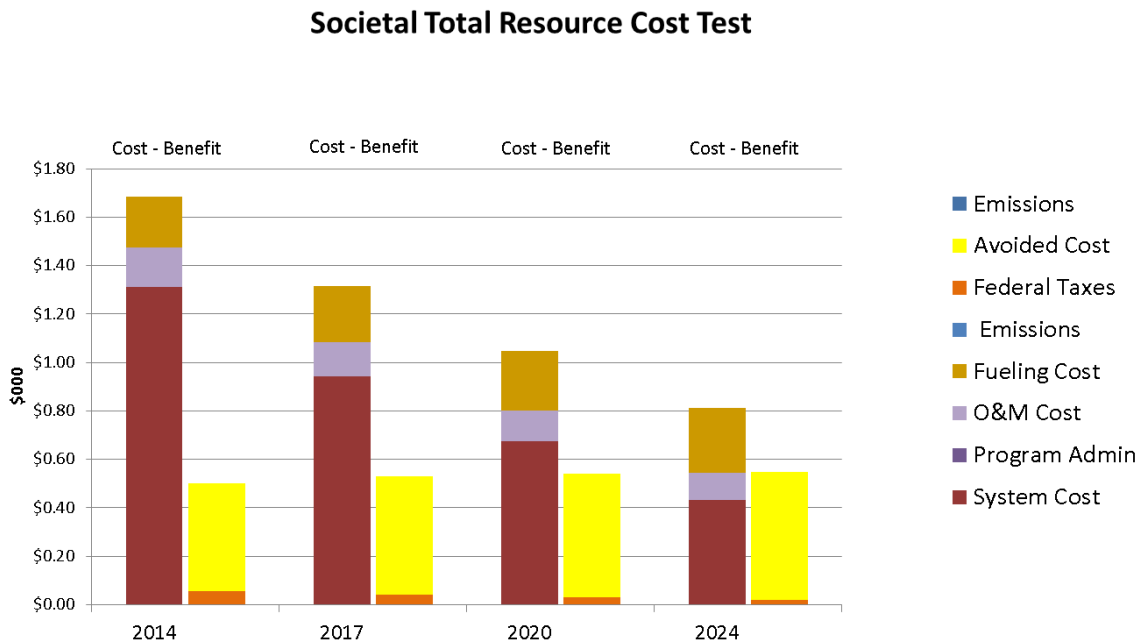
capacity during winter peak times and nearly 4 hours at half rated capacity during summer peak times. The 5 MW flow battery system is modeled with 20 MWh of energy capacity because flow batteries tend to have lower power to energy ratios, and the discharge periods are modeled to be twice as long as the smaller systems. Systems installed at sites with significantly shorter peaks could have substantially better economics as the systems would discharge at higher power for a shorter time.

Residential 5 kW Storage

Figure 6-6 shows the STRC test results for a nominal 5 kW residential energy storage system without incentives. Costs steadily decline from year to year. In contrast, benefits grow slowly. Costs are largely driven by system cost but as those fall over time, rising charging (shown as fueling) costs become more dominant. Benefits are almost entirely avoided costs with some small amount of tax savings.¹² This system is assumed to be on a TOU rate so avoided costs result from energy arbitrage.

Under the specified conditions, the 5 kW residential system reaches only a benefit-to-cost ratio of 0.67 by 2024. Nonetheless, under the demonstrated trends, the 5 kW storage system should achieve societal cost effectiveness sometime after 2024.

FIGURE 6-6: REPRESENTATIVE STRC TEST RESULTS FOR RESIDENTIAL 5 KW STORAGE SYSTEM



Commercial 30 kW Storage STRC

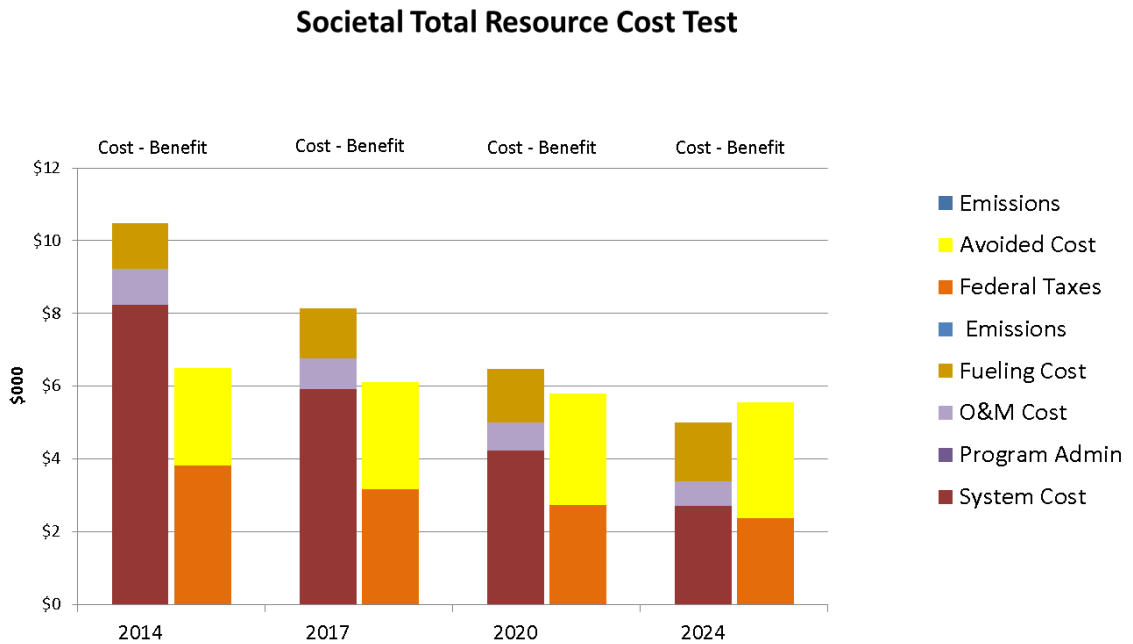
Model runs from the 2014 SGIPce find that mid-sized storage reaches an STRC benefit cost-ratio of slightly greater than 1 in most areas by 2024; 1.11 in PG&E territory, 1.02 for SDG&E, but falls slightly

¹² Tax savings for residential AES result from interest deductions from financing the system.



short at 0.97 for SCE by 2024. Figure 6-7 shows the costs and benefits broken out for PG&E. In this instance, benefits are driven by avoided costs and reductions in federal taxes.¹³ Note that these benefits do not include benefits from ancillary services that storage could potentially provide to the grid since California does not currently allow behind-the-meter storage to bid into the ancillary services market. Costs are initially dominated by installed costs, but like residential storage, costs become more dominated by charging costs (shown as fueling costs) as installed costs shrink.

FIGURE 6-7: REPRESENTATIVE STRC TEST RESULTS FOR COMMERCIAL 30 KW STORAGE SYSTEM



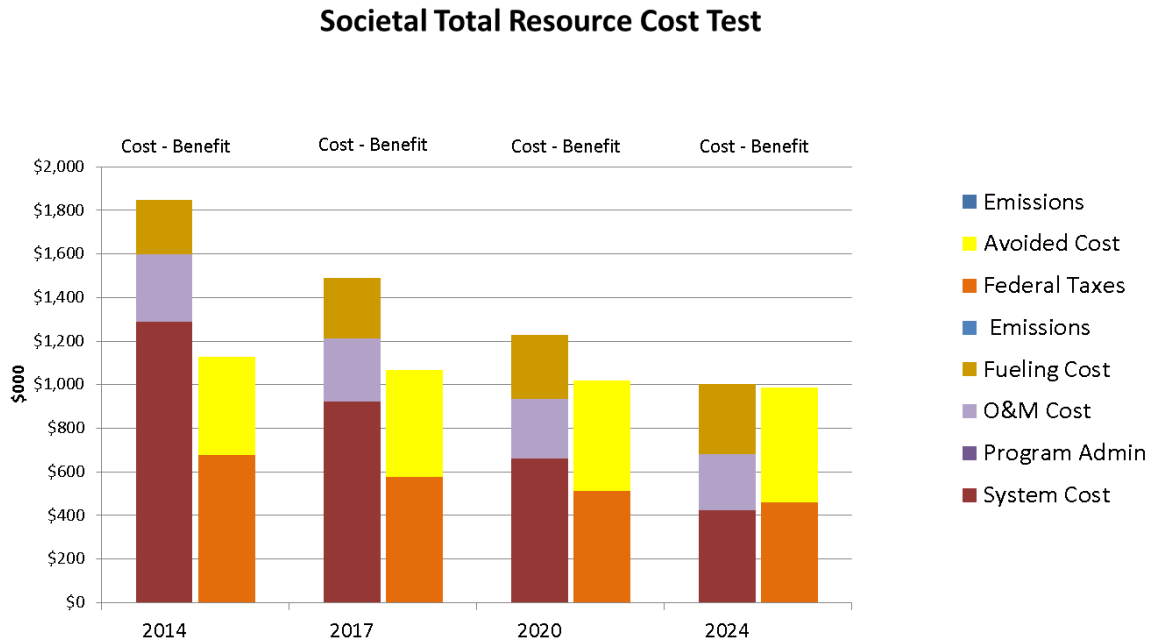
Commercial 5 MW Storage STRC

Figure 6-8 shows the representative STRC results for a 5 MW storage system. This system reaches a STRC of 0.99 in 2024.

¹³ Tax savings for commercial AES result from equipment depreciation, interest (from financing the system), and deductions and lower taxes on operating income.



FIGURE 6-8: REPRESENTATIVE STRC TEST RESULTS FOR COMMERCIAL 5 MW STORAGE SYSTEM



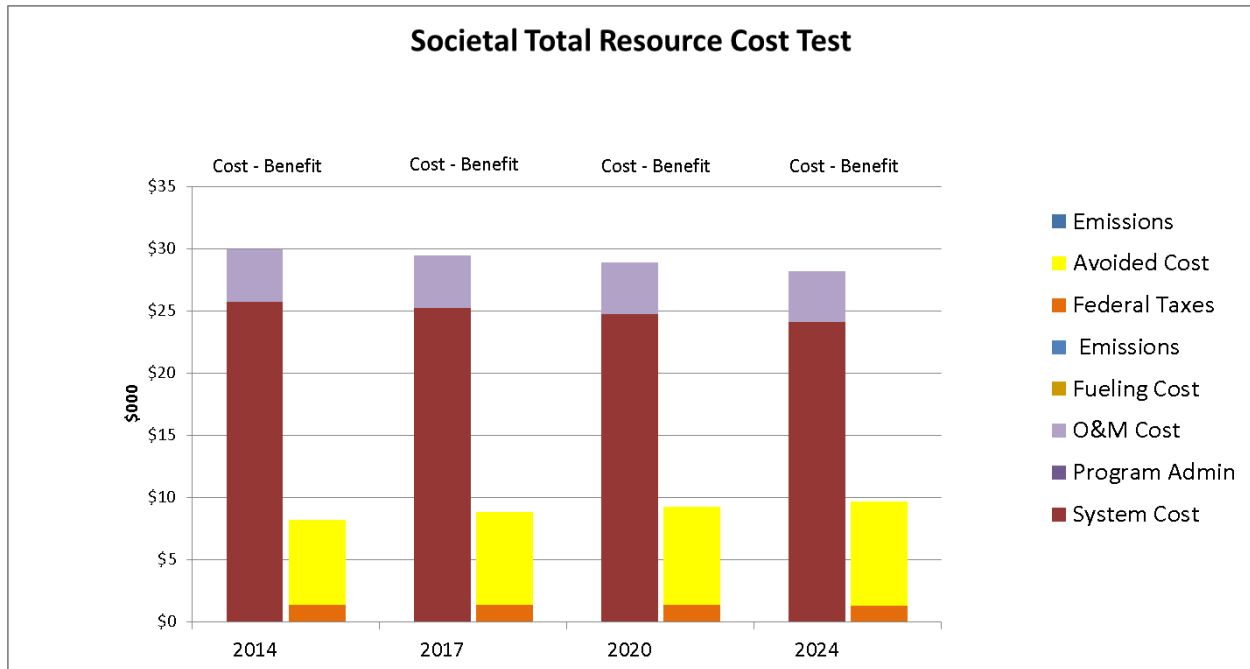
WIND ENERGY

We evaluated two sizes of wind turbines: a 50 kW wind turbine that could be used in a rural residential application (e.g., on a farm or ranch) and a 1.5 MW wind turbine for commercial applications.

Wind energy is an intermittent resource and electricity is generated only when the wind speed is sufficiently high to power the turbine. As such, wind energy systems have average annual capacity factors significantly lower than conventionally fueled engines or gas turbines. However, wind energy systems benefit from avoided fuel purchases.

Residential 50 kW Wind STRC

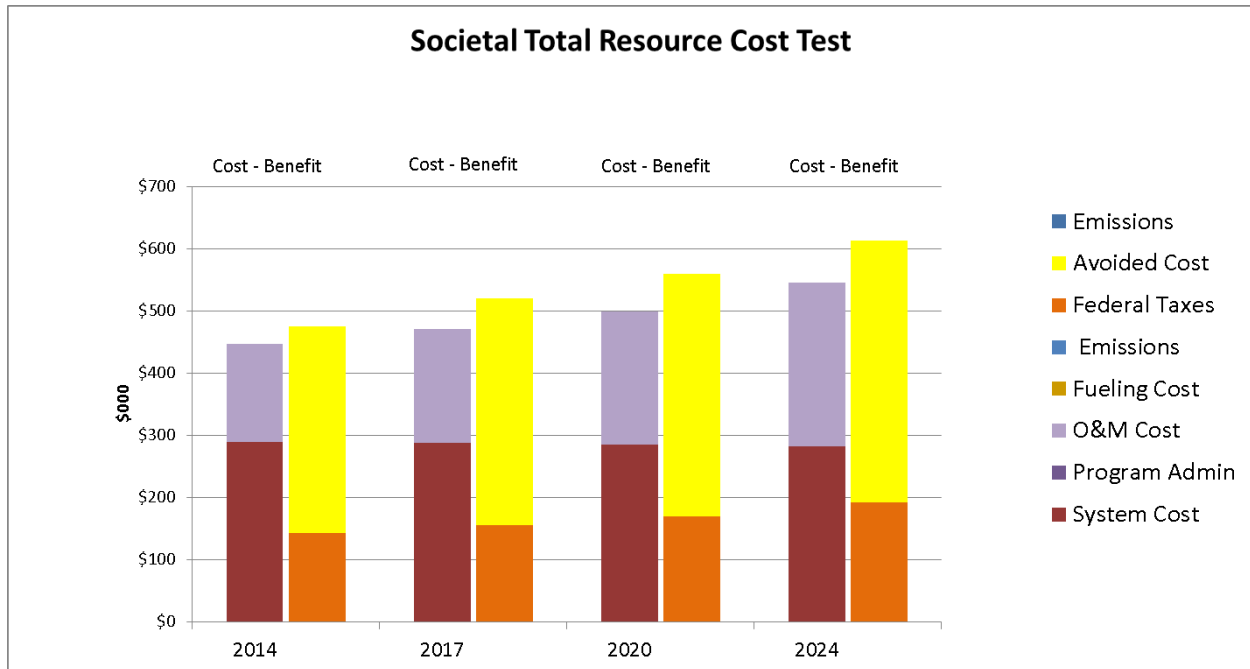
Figure 6-9 shows the STRC results for a representative 50 kW wind energy system deployed in PG&E’s service territory. Due to the lower amount of power generated by the wind energy system relative to the system cost, the benefit-cost ratio in 2014 is only 0.27. Because system costs are not expected to drop significantly over the next ten years, the ratio remains low, reaching only 0.34 by 2024.

FIGURE 6-9: REPRESENTATIVE STRC TEST RESULTS FOR 50 KW WIND SYSTEM


Commercial 1.5 MW Wind STRC

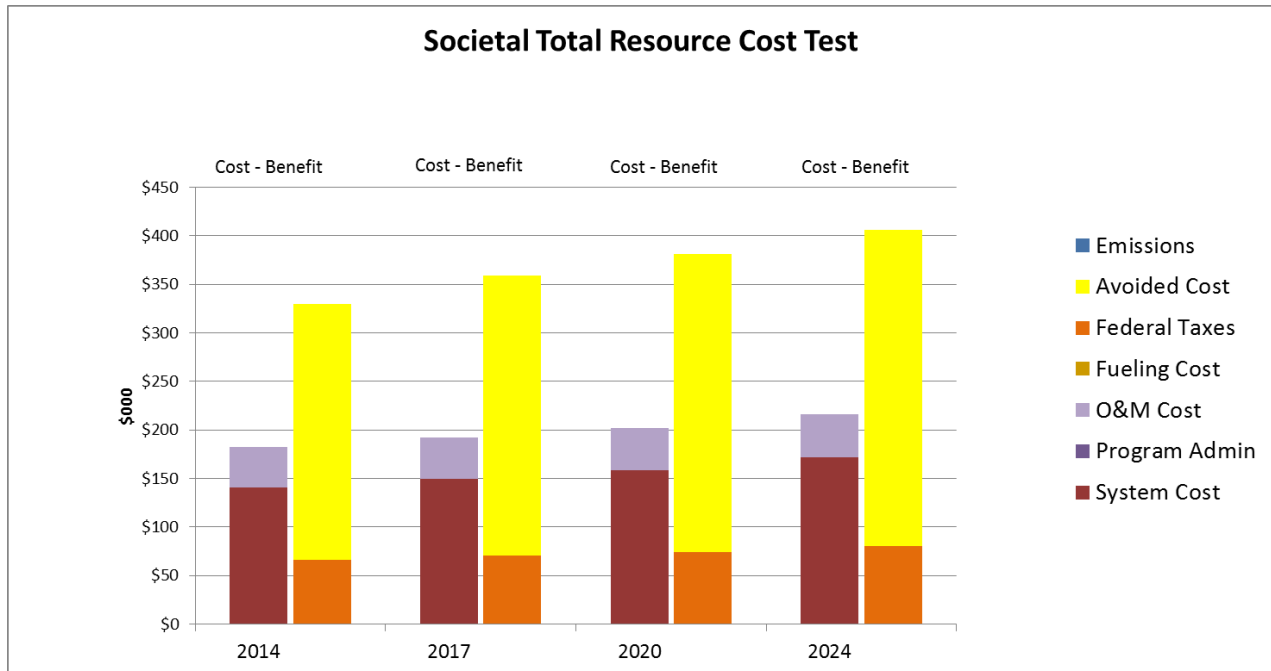
Figure 6-10 provides the STRC benefit-cost results for a representative 1.5 MW wind turbine. Larger wind energy systems tend to have higher hub heights¹⁴ and are exposed to wind speeds that are consistently higher than those of the smaller 50 kW systems. Due to the higher power production levels relative to the system costs, the 1.5 MW wind turbine system shows benefit-cost ratios of greater than 1 for all examined years.

¹⁴ The hub height is the distance from the turbine platform to the rotor of an installed wind turbine and indicates how high the wind turbine stands above the ground, not including the length of the turbine blades. Commercial scale turbines (greater than 1MW) are typically installed at 80 m (262 ft.) or higher, while small-scale wind turbines (approximately 10kW) are installed on shorter towers. Wind speed increases with height above ground.

FIGURE 6-10: REPRESENTATIVE STRC TEST RESULTS FOR 1.5 MW WIND SYSTEM


PRESSURE REDUCTION TURBINES

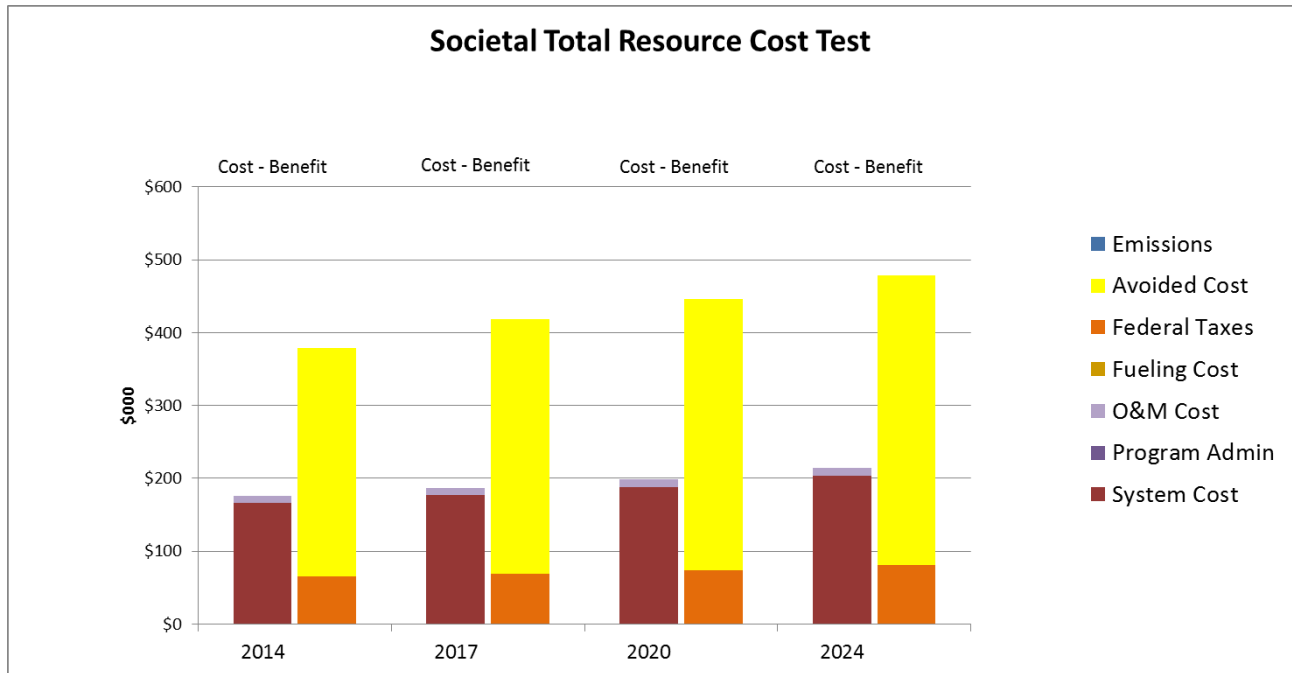
Figure 6-11 shows the STRC test results for a nominal 400 kW Pressure Reduction Turbine (PRT) system. PRT systems have a high value in avoided cost from a societal perspective. The benefit-cost ratio starts at 1.80 in 2014 and increases to 1.89 by 2024. High avoided cost is the major contributor to the benefits and it increases with rising electricity prices. In turn, system and O&M costs are low relative to the magnitude of the avoided cost benefits, which act to drive up the benefit-cost ratios. We expect only small learning curve effects to this size of PRT technology between 2014 and 2024. Consequently, instead of dropping, inflation exceeds the learning curve effect and system costs increase slightly over time.

FIGURE 6-11: REPRESENTATIVE STRC TEST RESULTS FOR 400 KW PRESSURE REDUCTION TURBINE SYSTEM


WASTE HEAT TO POWER

Figure 6-12 shows the STRC test results for a nominal 500 kW Organic Rankine Cycle (ORC) system. With or without incentives, ORC systems demonstrate a high value from a societal perspective largely due to avoided electricity costs. The benefit-cost ratio starts at 2.15 in 2014 and increases to 2.23 by 2024. Similar to the PRT technology, the system and O&M costs are significantly lower than the avoided cost benefits, thereby driving up the benefit-cost ratio.

This increase in the benefit-cost ratio is conservative given system costs increase during the same time period. The system costs increase over time because we expect little reduction in ORC costs due to learning curve effects and so inflation dominates the cost trend in this analysis. Normally, one would expect system costs to decrease over time due to learning and experience. In this case, due to a lack of information on costs of ORC technology, we had to assume a progress ratio of one.

FIGURE 6-12: REPRESENTATIVE STRC TEST RESULTS FOR 500 KW WASTE HEAT TO POWER SYSTEM


Natural Gas-Fueled Technologies

SGIP technologies fueled by natural gas include fuel cells (both electric-only and CHP-fuel cells that recover waste heat for onsite purposes), gas turbines, IC engines and microturbines.

Figure 6-13 shows the STRC results for natural gas fueled SGIP technologies at 2014 and 2020 with no incentives. In general, the larger capacity technologies (i.e., the 1.5 MW IC engine, the 2.5 MW gas turbine, and the 7 MW gas turbine) show higher STRC benefit-cost ratios than the smaller capacity technologies. In addition, note that all the technologies show decline in the STRC benefit-cost ratios between 2014 and 2020; although the decline is generally small. Lastly, the chart shows that the natural gas powered 500 kW fuel cell-all electric, the 200 kW microturbine, and the 1.2 MW fuel cell all have STRC benefit-cost ratios that fall significantly below 0.8 in both 2014 and 2020.

FIGURE 6-13: STATEWIDE STRC RESULTS BY NATURAL GAS FUEL TECHNOLOGIES (2014 AND 2020), NO INCENTIVES

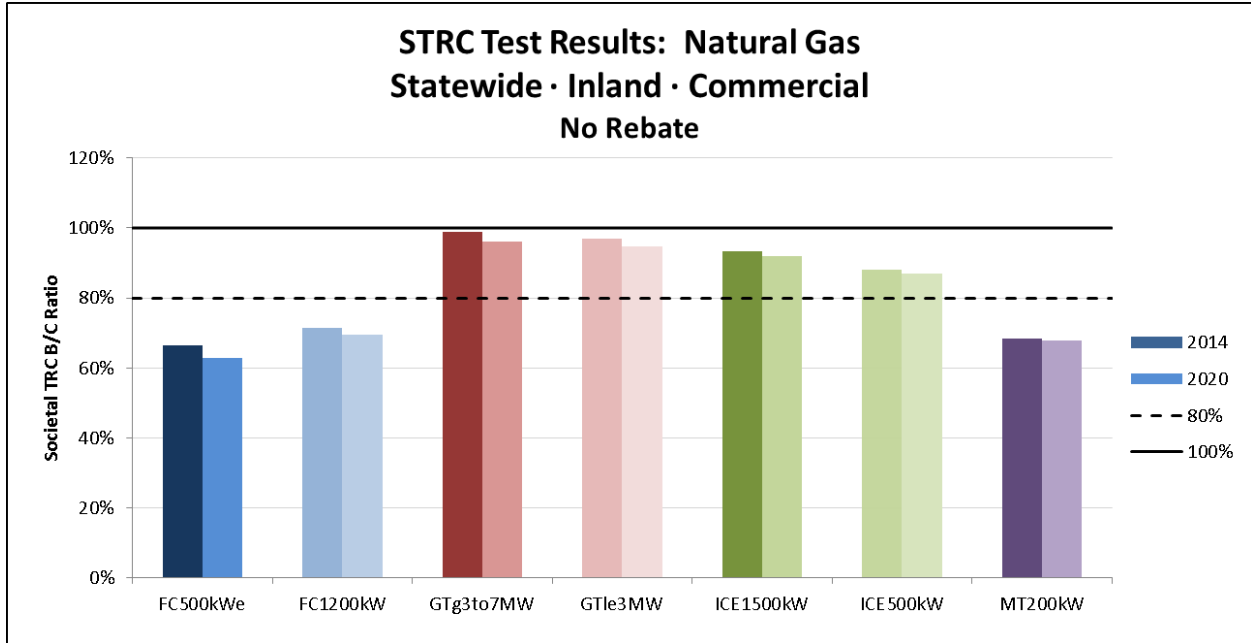


Figure 6-14 and Table 6-3 provide additional details on the STRC cost and benefit components for SGIP technologies fueled by natural gas.¹⁵

In general, most of the natural gas fueled SGIP technologies have STRC benefit-cost ratios below 1 at 2014. The exceptions are both gas turbines at 2.5 MW and 7 MW. The 1.5 MW IC engine is close with a benefit-cost ratio of 0.94. In all three of these instances, avoided costs and federal tax benefits have played a strong role in the higher benefit-cost ratios. Additional insights are available by examining the different natural gas fueled technologies.

¹⁵ The STRC does not include the incentive, REC revenue, state taxes, or avoided bills so these potential costs and benefits are not included in the table. When there are no incentives, there is no program, so the program administrator costs are zero and not included in the table.



FIGURE 6-14: STRC LEVELIZED COST AND BENEFIT COMPONENTS FOR NATURAL GAS SGIP TECHNOLOGIES, PG&E TERRITORY, NO INCENTIVE, 2014

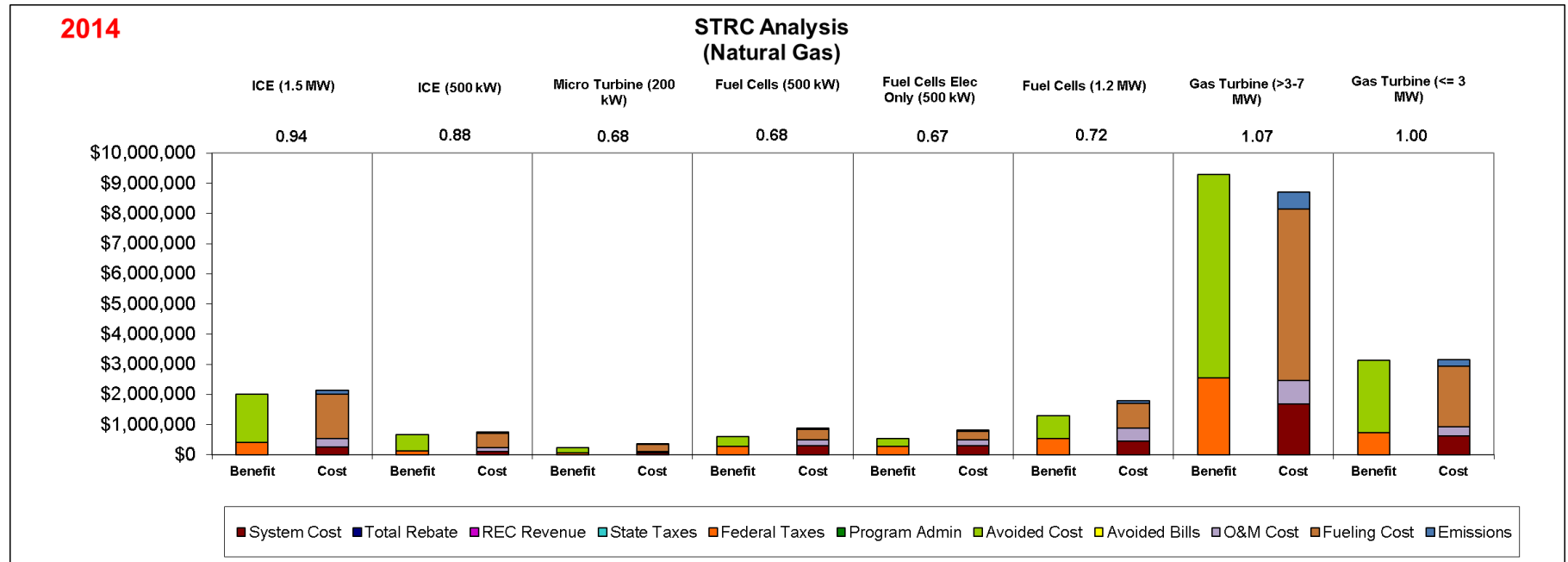




TABLE 6-3: STRC TEST LEVELIZED COST AND BENEFITS FOR NATURAL GAS SGIP TECHNOLOGIES, PG&E TERRITORY, NO INCENTIVE, 2014

Cost Test 2014	ICE (1.5 MW)		ICE (500 kW)		Micro Turbine (200 kW)		Fuel Cells (500 kW)		Fuel Cells Elec Only (500 kW)		Fuel Cells (1.2 MW)		Gas Turbine (>3-7 MW)		Gas Turbine (<= 3 MW)	
	STRC		STRC		STRC		STRC		STRC		STRC		STRC		STRC	
	Benefit\$	Cost\$	Benefit\$	Cost\$	Benefit\$	Cost\$	Benefit\$	Cost\$	Benefit\$	Cost\$	Benefit\$	Cost\$	Benefit\$	Cost\$	Benefit\$	Cost\$
System Cost	--	261,159	--	109,873	--	53,346	--	309,345	--	309,345	--	445,456	--	1,676,140	--	625,606
Total Rebate	--	--	--	--	--	--	--	--	--	--	--	--	--	--	--	--
REC Revenue	--	--	--	--	--	--	--	--	--	--	--	--	--	--	--	--
State Taxes	--	--	--	--	--	--	--	--	--	--	--	--	--	--	--	--
Federal Taxes	402,308	--	132,546	--	57,002	--	283,256	--	284,743	--	533,898	--	2,548,279	--	724,582	--
Program Admin	--	--	--	--	--	--	--	--	--	--	--	--	--	--	--	--
Avoided Cost	1,614,374	--	538,125	--	181,206	--	315,700	--	263,073	--	757,681	--	6,747,346	--	2,409,767	--
Avoided Bills	--	--	--	--	--	--	--	--	--	--	--	--	--	--	--	--
O&M Cost	--	277,299	--	117,888	--	44,336	--	190,088	--	190,088	--	435,234	--	788,224	--	291,151
Fueling Cost	--	1,477,706	--	492,569	--	247,260	--	347,872	--	276,878	--	834,893	--	5,679,251	--	2,028,304
Emission	--	126,223	--	42,074	--	7,090	--	30,059	--	40,478	--	72,141	--	565,863	--	202,094
Standby Charges	--	--	--	--	--	--	--	--	--	--	--	--	--	--	--	--
Total	2,016,682	2,142,386	670,671	762,404	238,208	352,032	598,956	877,363	547,816	816,788	1,291,579	1,787,724	9,295,625	8,709,478	3,134,349	3,147,155
Net Benefit		(125,705)		(91,733)		(113,824)		(278,407)		(268,971)		(496,145)		586,147		(12,807)
Ratio		0.94		0.88		0.68		0.68		0.67		0.72		1.07		1.00



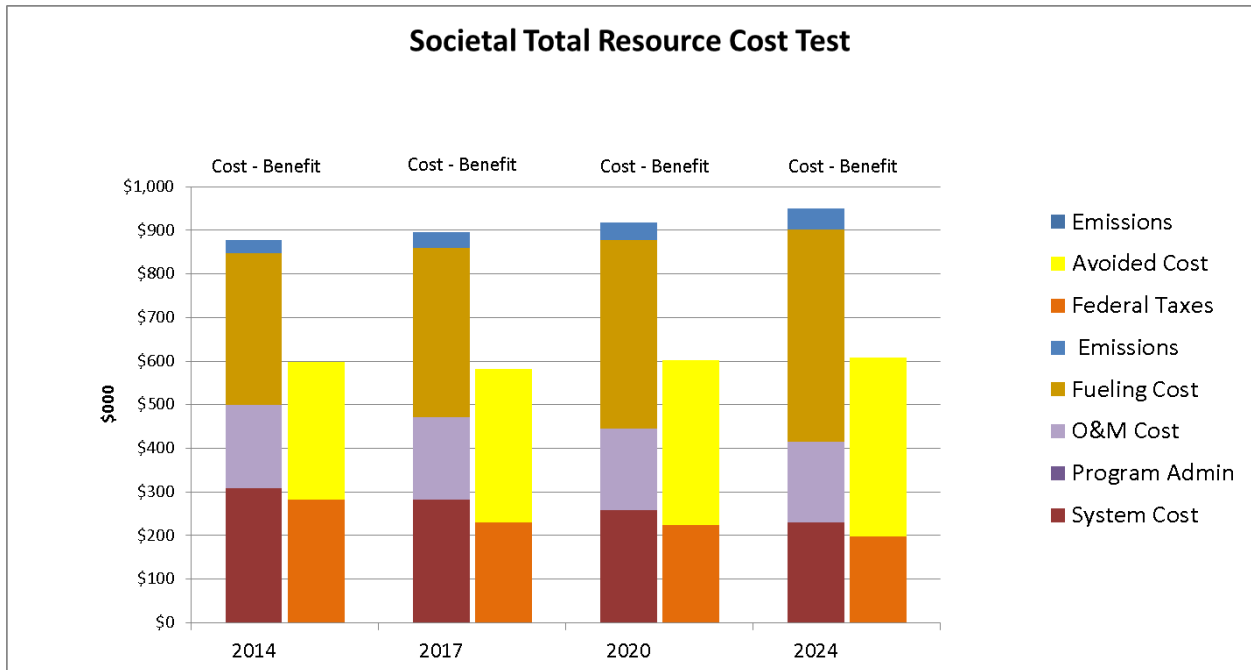
FUEL CELL TECHNOLOGIES

Relative to other natural gas fueled prime movers, fuel cells tend to have higher electrical efficiencies, often exceeding 40 percent. Due to their very low NOx emissions, fuel cells are seeing increased use in commercial applications. We evaluated electric only fuel cells at 500 kW capacity and CHP fuel cells at 500 kW and 1.2 MW capacity.

Commercial 500 kW Natural Gas-Powered CHP Fuel Cell STRC

Figure 6-15 shows representative STRC results for a 500 kW natural gas CHP fuel cell. Gas avoided costs (shown as fueling costs) are the largest contributor to societal costs, followed by system capital and O&M costs. Electricity avoided costs and federal taxes represent the two benefits to society. Increasing electricity rates and decreasing system and O&M costs tend to increase future cost-benefit ratios, but the net impact of increasing fueling costs and decreasing federal tax benefits drive the benefit-cost ratio from 0.68 in 2014 to 0.64 by 2024.

FIGURE 6-15: REPRESENTATIVE SOCIETAL TOTAL RESOURCE COST TEST FOR A NATURAL GAS 500 KW CHP FUEL CELL

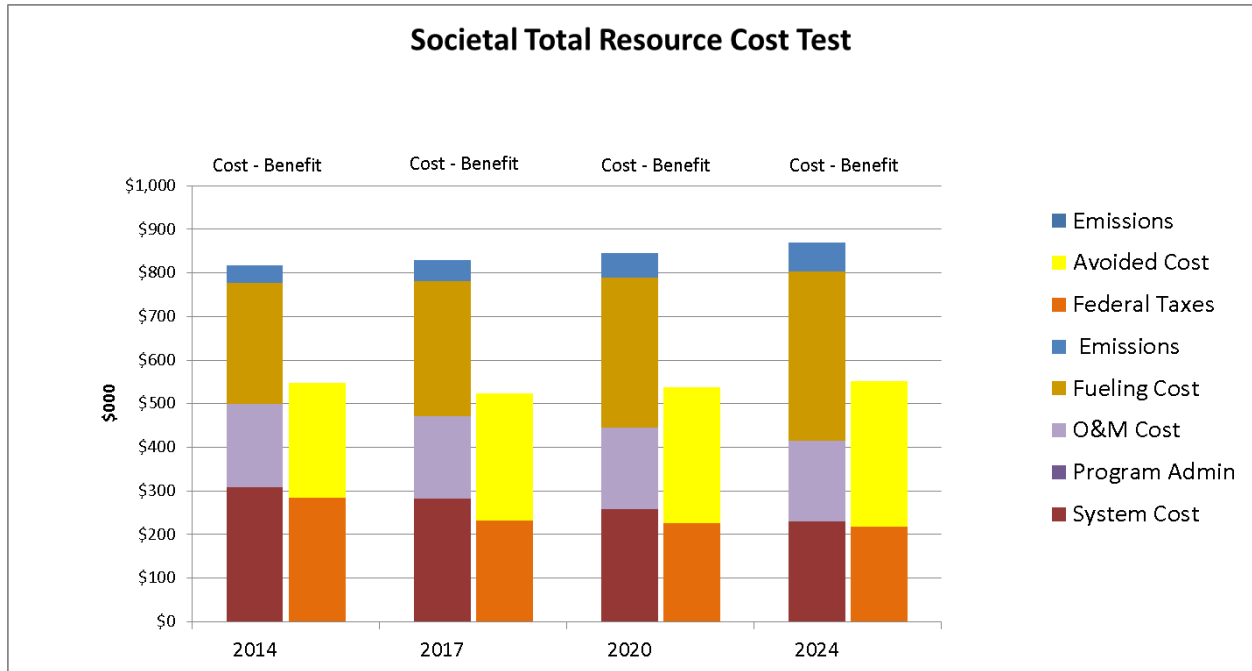


Commercial 500 kW Natural Gas-Powered Electric Only Fuel Cell STRC

Figure 6-16 shows STRC results for a 500 kW electric-only fuel cell running on natural gas. The results are similar to the 500 kW CHP fuel cell – in this case the relationship between electric avoided costs and gas fueling costs is slightly different due to the increased electrical efficiency and lack of useful heat recovery. For this scenario the model shows a societal benefit-cost ratio of 0.67 in 2014, decreasing to 0.63 by 2024.



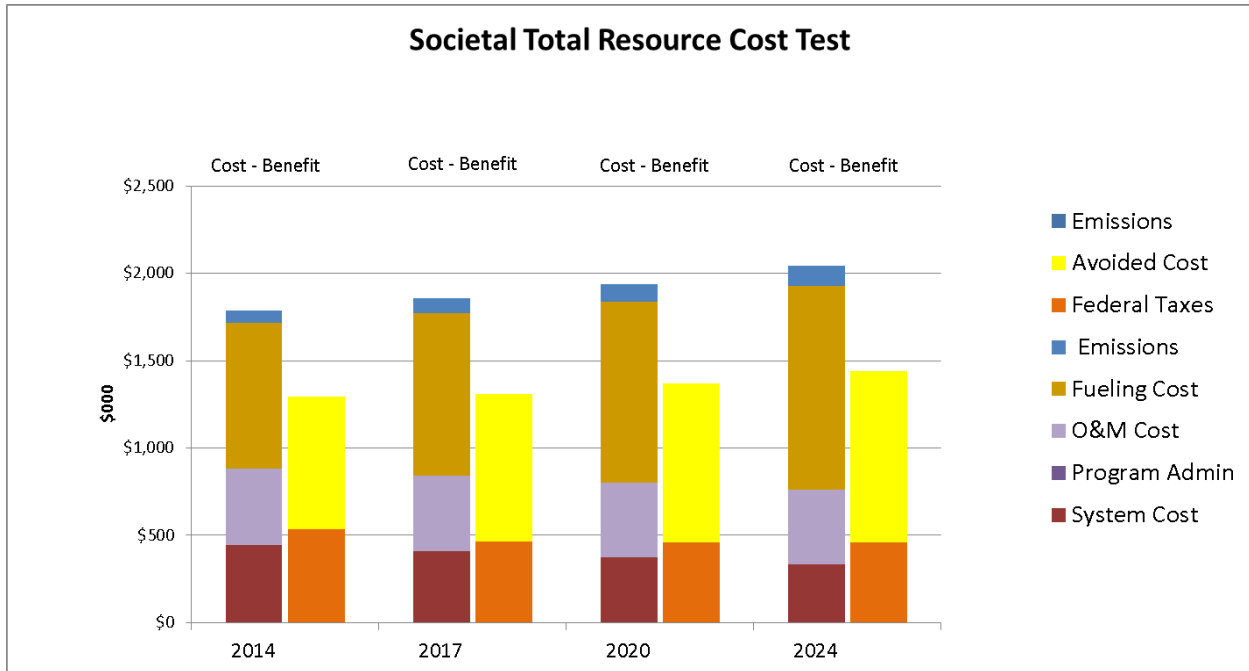
FIGURE 6-16: REPRESENTATIVE SOCIETAL TOTAL RESOURCE COST TEST FOR A NATURAL GAS 500 KW ELECTRIC-ONLY FUEL CELL



Commercial 1200 kW Natural Gas-Powered CHP Fuel Cell STRC

Figure 6-17 shows STRC results for a 1,200 kW natural gas CHP fuel cell. As with the 500 kW CHP fuel cell, fueling costs are the largest component of the societal costs and contribute to the costs exceeding the societal benefits. In SGIPce, the 1,200 kW fuel cell has lower capital costs per Watt than the 500 kW fuel cell. Despite this improvement, the societal benefit-cost ratio remains relatively flat between 0.72 in 2014 and 0.71 by 2024.

FIGURE 6-17: REPRESENTATIVE SOCIETAL TOTAL RESOURCE COST TEST FOR A NATURAL GAS 1,200 KW CHP FUEL CELL



GAS TURBINE TECHNOLOGIES

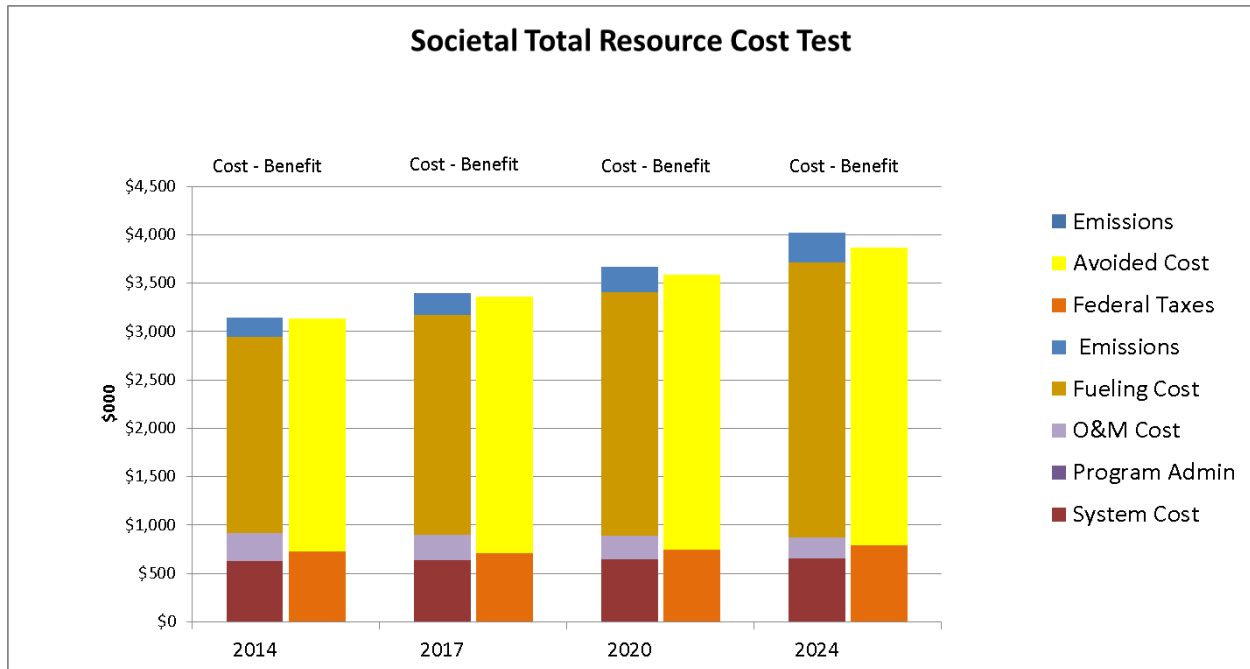
We examined two sizes of gas turbine technologies: a 2.5 MW gas turbine suitable for use in medium-sized commercial applications such as food processing plants; and a 7 MW gas turbine that could be used in commercial or small industrial applications. For this cost effectiveness study, we have assumed that only gas turbines fueled by natural gas are operated as combined heat and power systems. To remain consistent with SGIP Handbook guidelines, which do not require technologies fueled by biogas to recover waste heat, we assume gas turbines fueled by directed biogas or onsite biogas are not operated as combined heat and power systems.

Commercial 2.5 MW Natural Gas-Fueled Gas Turbine STRC

Figure 6-18 shows the STRC benefit-cost results for a representative 2.5 MW gas turbine fueled by natural gas. Overall, the benefit-cost ratio remains close to 1 across all years. Interestingly, the benefit-cost ratio drops only slightly over time from 1.0 in 2014 to 0.96 by 2020. While avoided costs rise over time, fueling costs rise at a slightly higher rate over the same time period, causing the observed small drop in the benefit-cost ratio.



FIGURE 6-18: REPRESENTATIVE STRC TEST RESULTS FOR 2.5 MW NATURAL GAS FUELED GAS TURBINE



Commercial 7 MW Natural Gas-Fueled Gas Turbine STRC

Figure 6-19 shows the STRC results for the representative 7 MW gas turbine. Like the smaller 2.5 MW system, the benefit-cost ratio declines between 2014 and 2020, but for the larger system always remains above a value of 1.



FIGURE 6-19: REPRESENTATIVE STRC TEST RESULTS FOR 7 MW NATURAL GAS FUELED GAS TURBINE

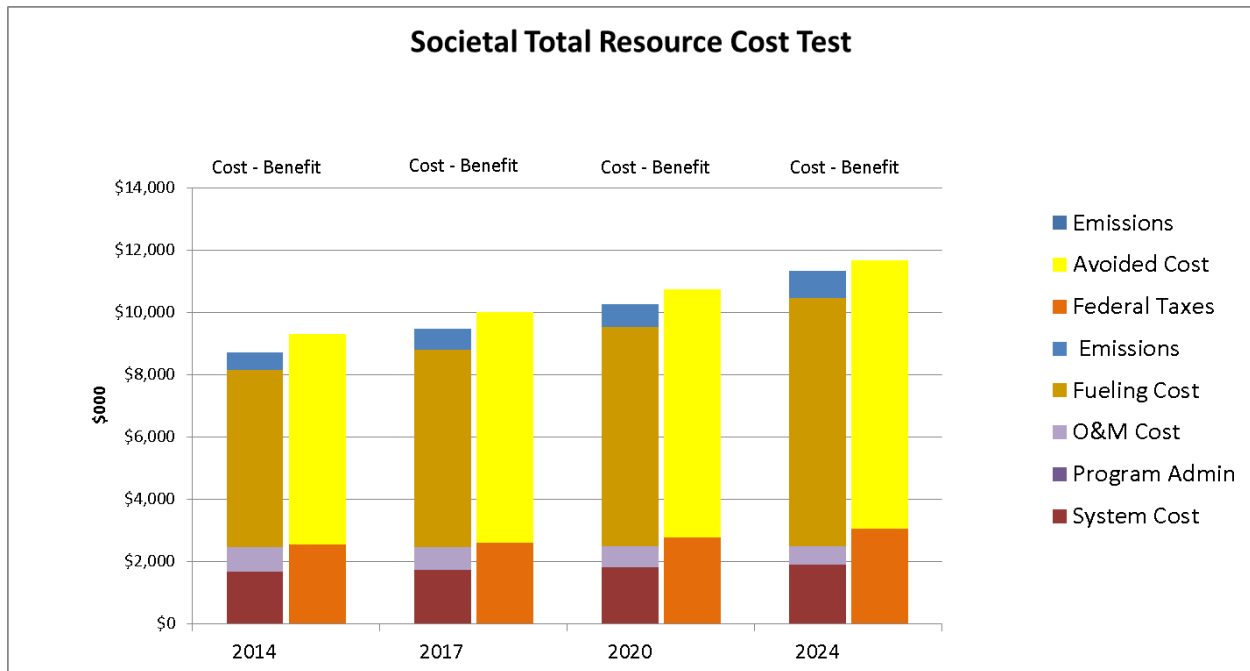


Table 6-4 provides a breakout of the STRC cost and benefit components for the 7 MW gas turbine system. These results show that in 2014, fueling costs and emission costs are exceeded by federal tax and avoided cost benefits. However, this trend erodes slightly moving from 2014 out to 2024. In essence, the increases in fueling costs and emissions overcome the benefits accruing from the avoided electricity costs and federal tax savings; thereby driving the benefit-cost ratio slightly lower each year.

TABLE 6-4: STRC COSTS AND BENEFITS FOR 7 MW GAS TURBINE FUELED BY NATURAL GAS, NO INCENTIVES

STRC Costs	2014	2017	2020	2024
	\$	\$	\$	\$
System Cost	1,676,140	1,737,844	1,801,821	1,890,801
Program Admin	--	--	--	--
O&M Cost	788,224	727,547	673,344	610,106
Fueling Cost	5,679,251	6,342,939	7,044,384	7,957,653
Emissions	565,863	654,511	744,034	858,764
Total Costs	8,709,478	9,462,841	10,263,583	11,317,323
Benefits				
Federal Taxes	2,548,279	2,586,977	2,771,841	3,039,939
Avoided Cost	6,747,346	7,427,473	7,970,837	8,614,898
Emissions	--	--	--	--
Total Benefits	9,295,625	10,014,450	10,742,677	11,654,837
Net Benefits	586,147	551,608	479,095	337,514
Ratio	1.07	1.06	1.05	1.03



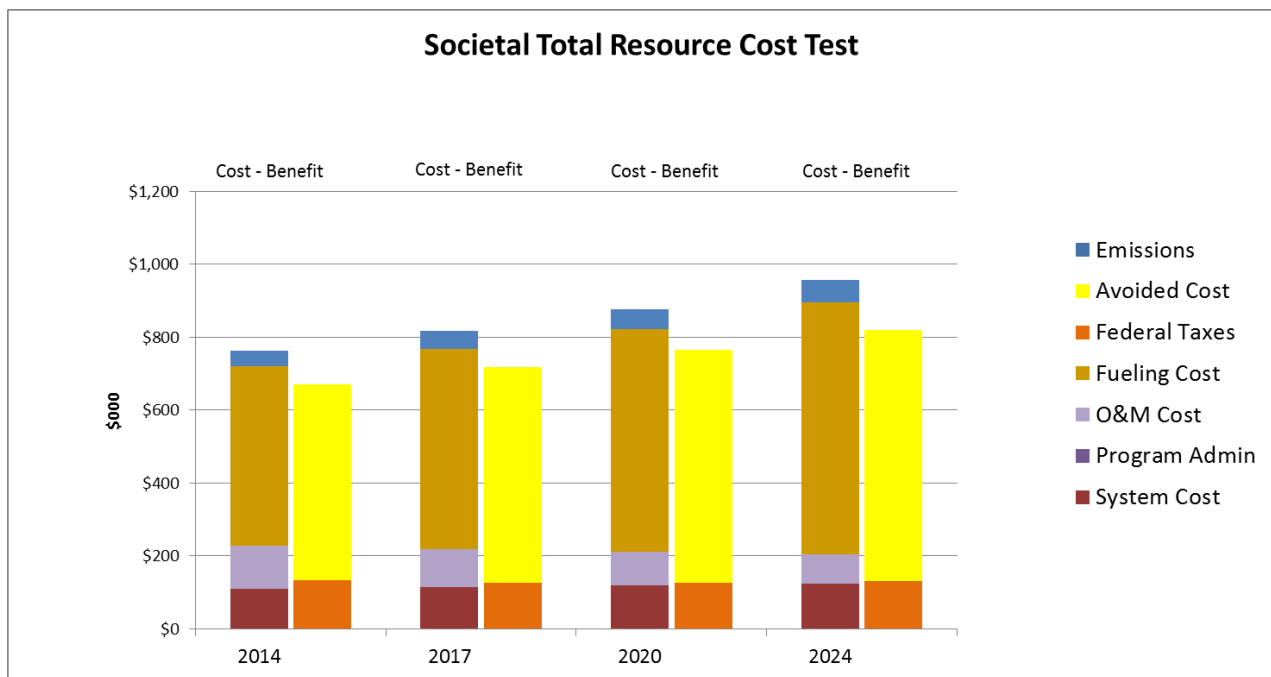
INTERNAL COMBUSTION ENGINE TECHNOLOGIES

We evaluated IC engines at two size ranges: 500 kW and 1.5 MW. Both of these sizes of IC engine are commonly used in commercial applications as combined heat and power systems. While higher efficiency IC engines using homogenous charge compression ignition (HCCI) approaches with lower NOx emissions are under development¹⁶, we have assumed the IC engines in this study use post combustion NOx controls. This assumption increases system costs above what was used in the 2011 cost effectiveness study.

Commercial 500 kW Natural Gas-Fueled IC Engine STRC

Figure 6-20 shows the STRC results for the representative 500 kW IC engine fueled with natural gas. Similar to gas turbines, rising fuel costs and emission costs outweigh the benefits from avoided electricity costs. As a result, the benefit-cost ratio remains flat at approximately 0.88 between 2014 and 2020.

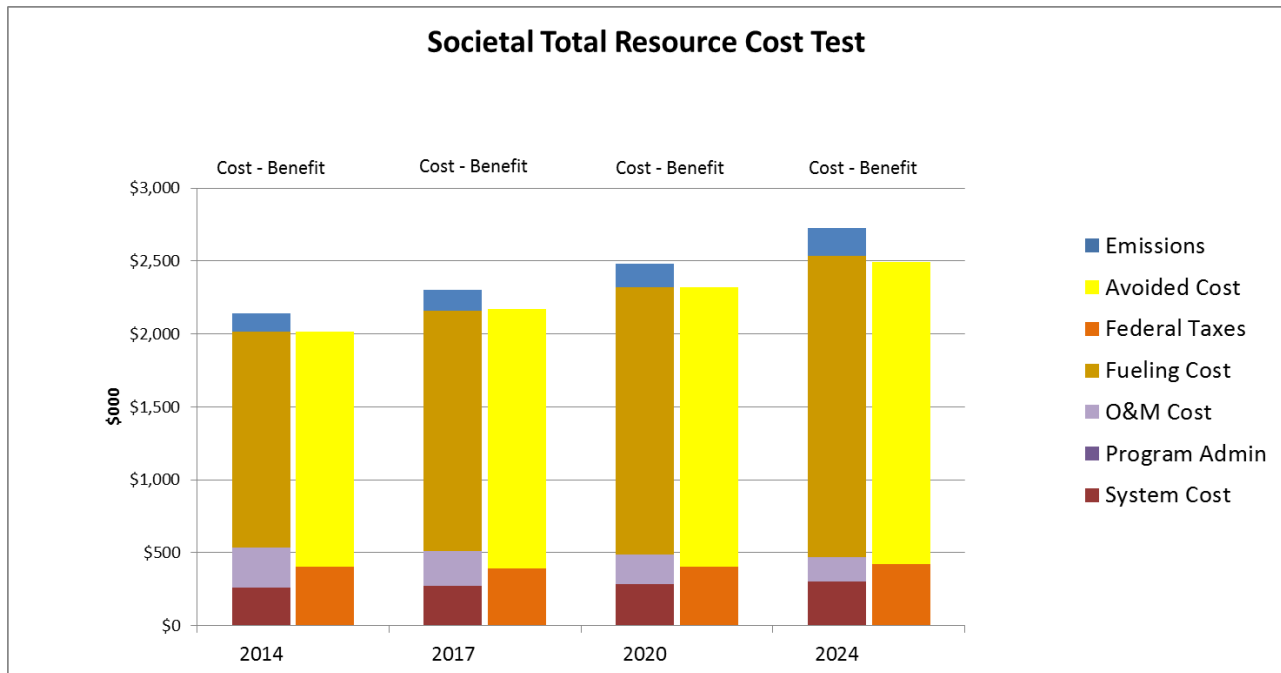
FIGURE 6-20: REPRESENTATIVE STRC RESULTS FOR 500 KW NATURAL GAS FUELED IC ENGINE



Commercial 1.5 MW Natural Gas-Fueled IC Engine STRC

STRC results for the 1.5 MW IC engine are shown in Figure 6-21. These results track the trend shown for the smaller 500 kW system. However, the larger IC engine has lower relative O&M costs than the smaller system. As a result, the benefit-cost ratio is somewhat higher staying at approximately 0.94 from 2014 through 2020.

¹⁶ For example, see “Low Cost, High Efficiency, Ultra-Low NOx ARICE Solution Using HCCI Combustion,” California Energy Commission, prepared by Lawrence Berkeley National Laboratory for the California Energy Commission, April 2010, CEC-500-2012-074.

FIGURE 6-21: REPRESENTATIVE STRC RESULTS FOR 1.5 MW NATURAL GAS FUELED IC ENGINE


MICROTURBINE TECHNOLOGIES

Microturbines are similar to their larger counterparts; aeroderivative gas turbines. Microturbines rotate at very high speeds (e.g., 80,000 revolutions per minute) which provide them fast ramping capability. This fast ramping capability makes them suitable for electrical load following applications within the commercial sector. In addition, due to combustion design features, microturbines have low NOx emissions, which preclude the need for expensive post-combustion air pollution control equipment. However, microturbines have demonstrated relatively low electrical efficiencies compared to larger gas turbines (i.e., 21% versus 32%). In addition, microturbines have typically not shown high useful waste heat recovery, which would tend to increase their net GHG emissions footprint. For this cost effectiveness study, we assumed microturbine performance would meet the minimum GHG emission requirements, which meant adjusting the useful waste heat recovery rates upwards from what had been observed in the past.¹⁷ Our evaluation focused on microturbines at a rating of 200 kW.

Commercial 200 kW Natural Gas-Fueled Microturbine STRC

Figure 6-22 provides the STRC results for a representative 200 kW microturbine fueled with natural gas.

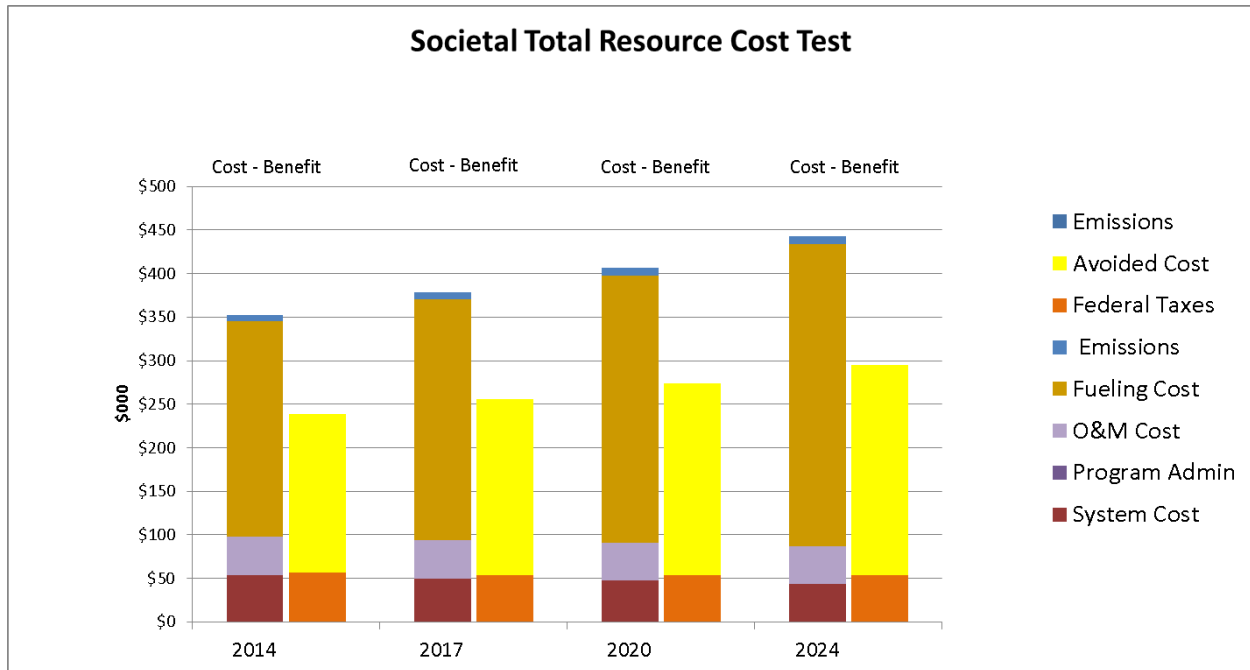
As depicted in the chart, fueling costs rise at a higher rate than the avoided electricity benefits from 2014 through 2020. This is reflective of the lower electrical efficiency of microturbines, which requires a greater amount of natural gas to be consumed for every kilowatt of electricity generated from the

¹⁷ SGIP impact evaluations have shown that microturbines implemented in the past under the SGIP have had low useful waste heat recovery rates. However, it is possible for microturbines to demonstrate increased useful waste heat recovery by being located at sites with high thermal demand. Increasing the useful waste heat recovery enables microturbines to achieve the required GHG emission levels without additional cost.



microturbine than from other generators such as IC engines. Consequently, even though system costs, emissions and O&M are relatively low, the high magnitude of the fueling costs and their rate of increase limit the STRC benefit-cost ratio to no more than 0.68.

FIGURE 6-22: REPRESENTATIVE STRC RESULTS FOR 200 KW NATURAL GAS FUELED MICROTURBINE



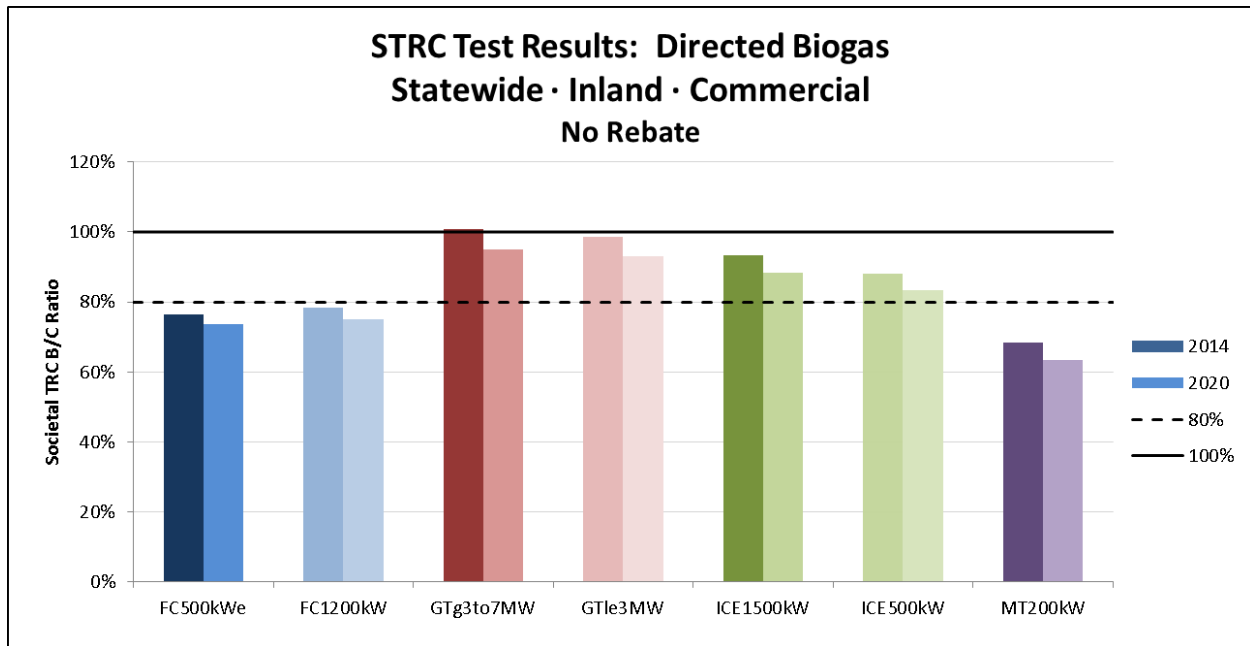
Directed Biogas-Fueled Technologies

Directed biogas refers to biogas that is produced at a location other than the project site. The procured biogas is processed, cleaned-up, and injected into a natural gas pipeline for distribution. Although the purchased biogas is not likely to be physically delivered and used at the renewable fuel project, the project is credited with the overall use of biogas resources.¹⁸

While directed biogas projects are not directly responsible for the additional system costs associated with biogas collection and processing, they indirectly pay for these costs through the additional charges on the delivered directed biogas. However, directed biogas projects qualify for Renewable Energy Credits and ITC treatment as though they were onsite biogas projects. This has important implications for cost effectiveness of these projects.

Figure 6-23 summarizes the 2014 and 2020 STRC results for SGIP technologies fueled by directed biogas without incentives.

¹⁸ In accordance with CPUC Decision 11-09-015, directed biogas projects must use biogas resources from within California. Out-of-state biogas resources do not qualify as directed biogas within the SGIP.

FIGURE 6-23: STATEWIDE SOCIETAL TRC RESULTS BY DIRECTED BIOGAS FUEL (2014 AND 2020), NO INCENTIVES


The results for directed biogas are similar to those seen for natural gas. However, technologies fueled by directed biogas tend to have slightly higher STRC benefit-cost ratios than technologies fueled by natural gas. This is due to the higher federal tax benefits associated with using the more expensive directed biogas. The higher tax benefits are a result of the higher directed biogas fueling costs, which lead to higher business costs and a higher federal tax benefit.

FUEL CELL TECHNOLOGIES

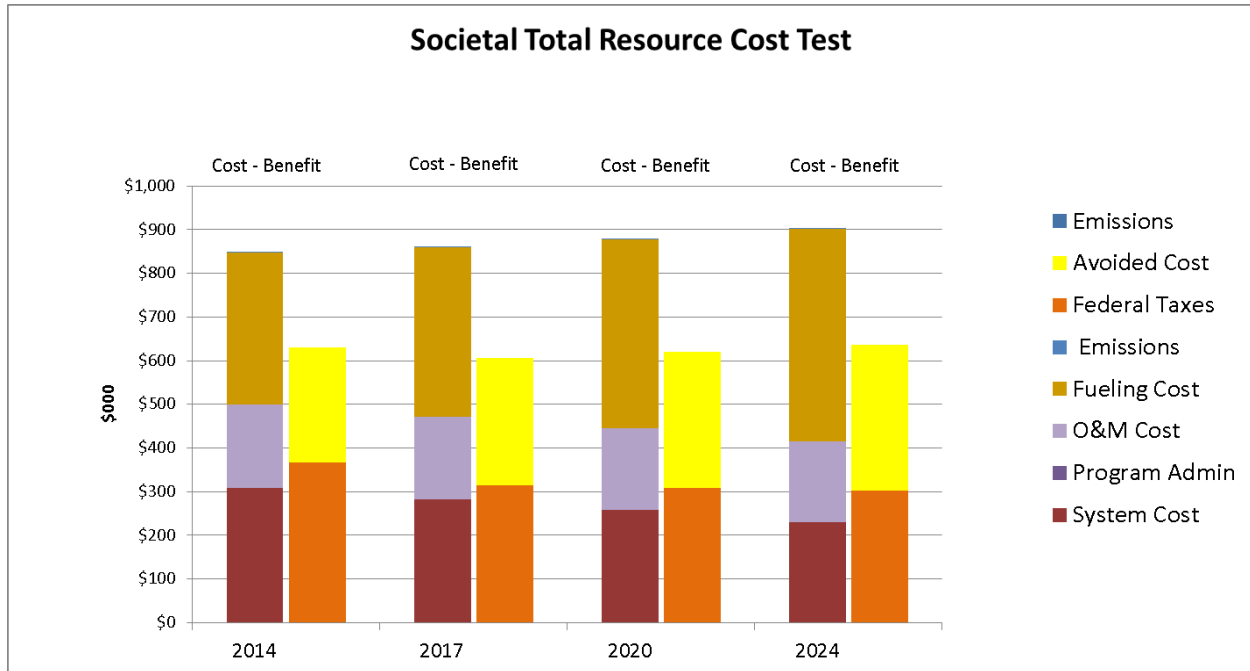
Directed biogas fuel cells face greater fueling costs due to the increased cost to procure and transport biogas in exchange for increased environmental benefits.

Commercial 500 kW Directed Biogas CHP Fuel Cell STRC

Figure 6-24 shows the STRC results for a 500 kW directed biogas CHP fuel cell. The system capital and O&M costs, combined with the fueling costs, exceed the societal benefits. In this case, the societal benefit-cost ratio decreases from 0.74 in 2014 to 0.70 by 2024.



FIGURE 6-24: REPRESENTATIVE SOCIETAL TOTAL RESOURCE COST TEST FOR A DIRECTED BIOGAS 500 KW CHP FUEL CELL

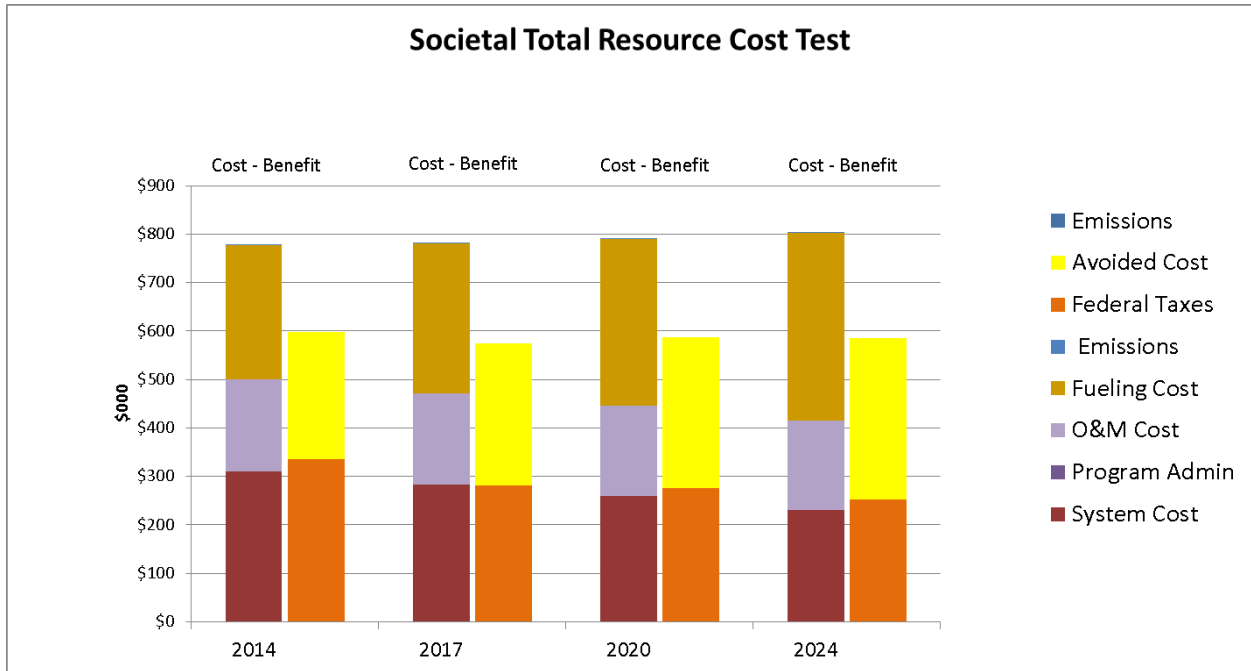


Commercial 500 kW Directed Biogas Electric Only Fuel Cell STRC

Figure 6-25 shows the STRC results for a 500 kW directed biogas electric-only fuel cell. As with the 500 kW CHP fuel cell, the societal costs exceed the benefits due to the high fueling costs. In this scenario, the societal benefit-cost ratio decreases from 0.77 in 2014 to 0.73 by 2024.



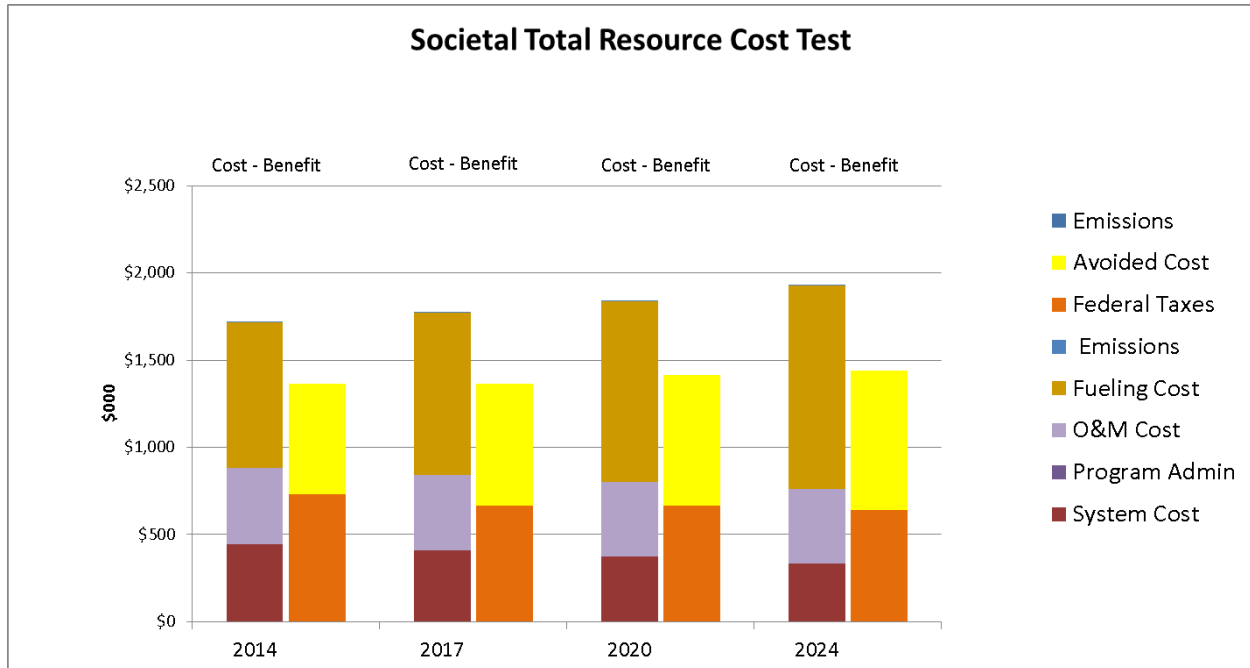
FIGURE 6-25: REPRESENTATIVE SOCIETAL TOTAL RESOURCE COST TEST FOR A DIRECTED BIOGAS 500 KW ELECTRIC-ONLY FUEL CELL



Commercial 1200 kW Directed Biogas CHP Fuel Cell STRC

Figure 6-26 shows the STRC results for a 1,200 kW directed biogas CHP fuel cell. Despite the lower capital costs per Watt of the larger fuel cells, the societal benefit-cost ratio is 0.79 for 2014 and decreases to 0.75 by 2024 due in part to increasing fueling costs.

FIGURE 6-26: REPRESENTATIVE SOCIETAL TOTAL RESOURCE COST TEST FOR A DIRECTED BIOGAS 1,200 KW CHP FUEL CELL



From a societal perspective, none of the directed biogas fuel cells were cost effective in 2014. All directed biogas fuel cells showed flat or decreasing societal benefit-cost ratios over time.

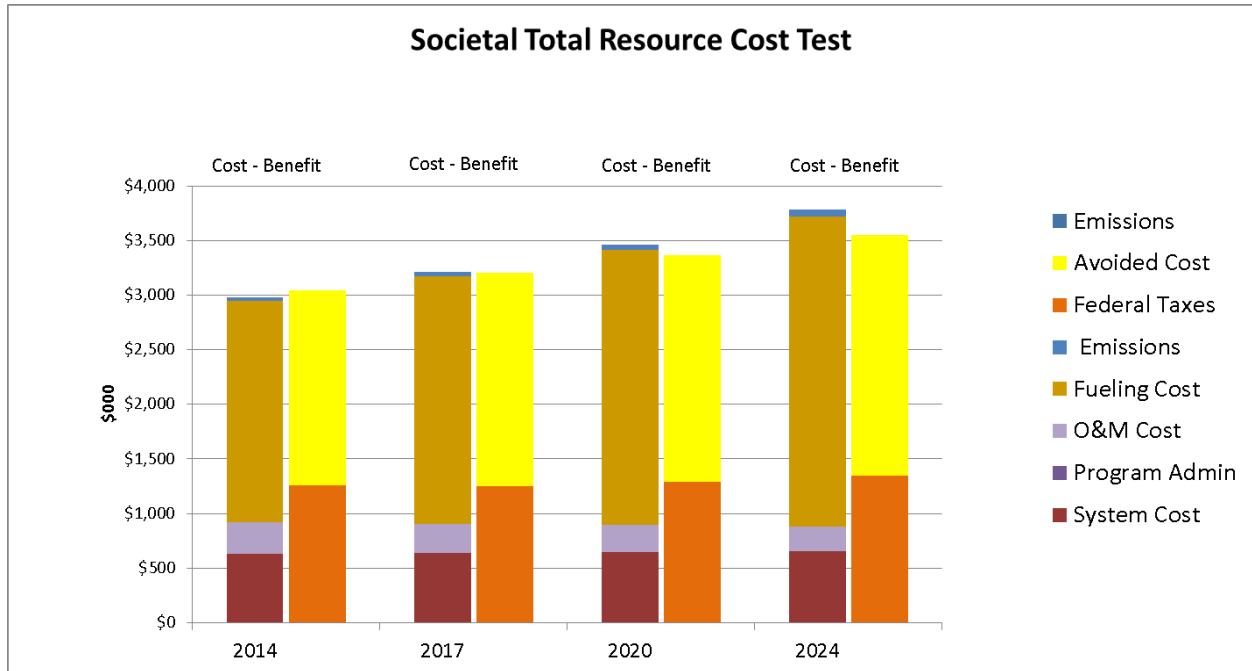
GAS TURBINE TECHNOLOGIES

Commercial 2.5 MW Directed Biogas-Fueled Gas Turbine STRC

Figure 6-27 shows the STRC results for a 2.5 MW gas turbine fueled by directed biogas. Overall, increasing fueling costs of the higher priced directed biogas exceed the avoided electricity benefits. The net result is a decline in the STRC benefit-cost ratio from 1.02 in 2014 down to 0.94 by 2024.



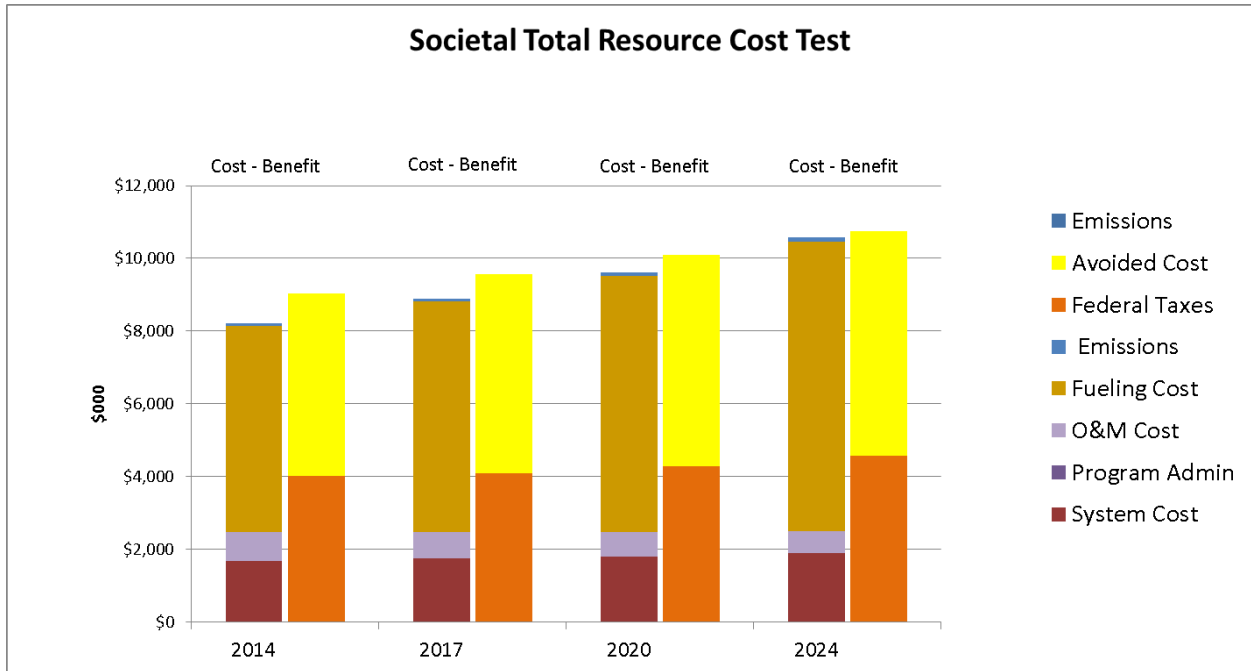
FIGURE 6-27: REPRESENTATIVE SOCIETAL TOTAL RESOURCE COST TEST FOR A DIRECTED BIOGAS 2.5 MW GAS TURBINE



Commercial 7 MW Directed Biogas-Fueled Gas Turbine STRC

Figure 6-28 presents the STRC results for a larger 7 MW gas turbine fueled by directed biogas. Similar to the smaller 2.5 MW gas turbine, the higher priced directed biogas costs exceed the avoided electricity benefits. While the STRC benefit-cost ratio remains above 1, it declines from 1.1 in 2014 to 1.02 by 2024.

FIGURE 6-28: REPRESENTATIVE SOCIETAL TOTAL RESOURCE COST TEST FOR A DIRECTED BIOGAS 7 MW GAS TURBINE



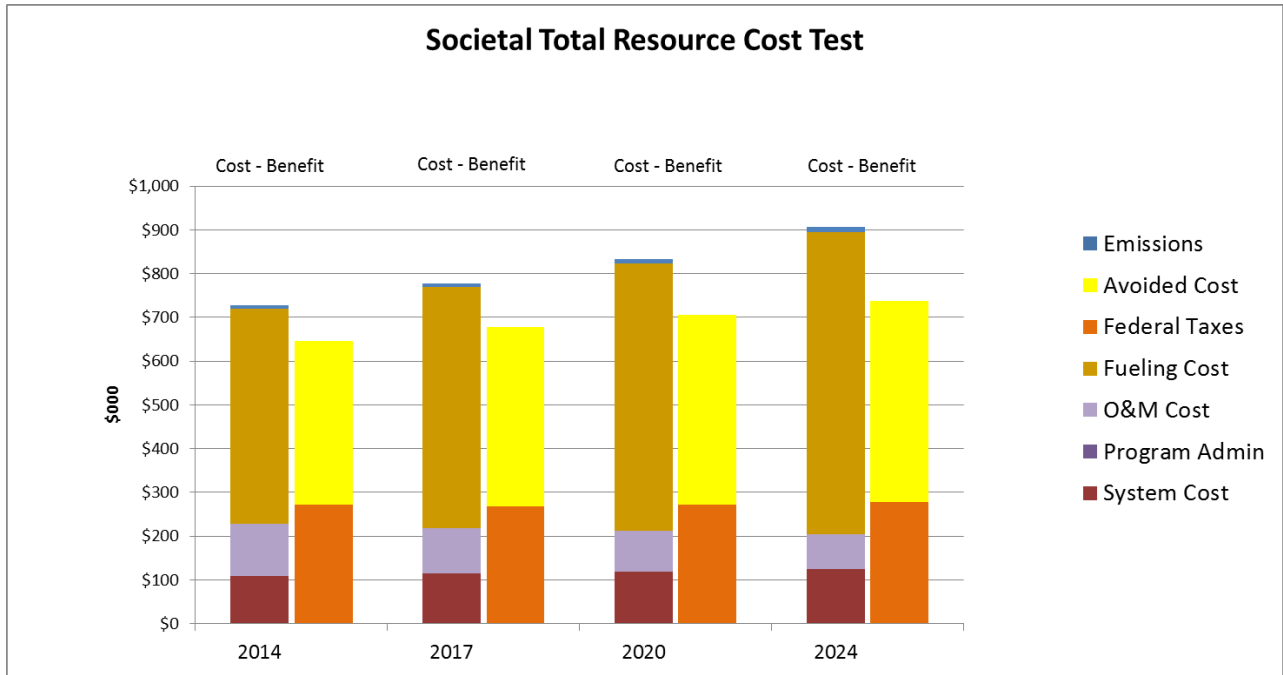
INTERNAL COMBUSTION ENGINE TECHNOLOGIES

Commercial 500 kW Directed Biogas-Fueled IC Engine STRC

Figure 6-29 provides the STRC results for a 500 kW IC engine fueled by directed biogas. Similar to gas turbines, the cost effectiveness challenge to IC engines is the higher fueling cost. In addition, emissions begin to emerge as a cost; although at a relatively low level. For the 500 kW IC engine, the STRC benefit-cost ratio does not reach 1 during the 2014-2024 timeframe. The highest ratio it achieves is 0.89 in 2014 and it declines steadily to 0.81 by 2024.



FIGURE 6-29: REPRESENTATIVE STRC FOR A DIRECTED BIOGAS 500 KW IC ENGINE

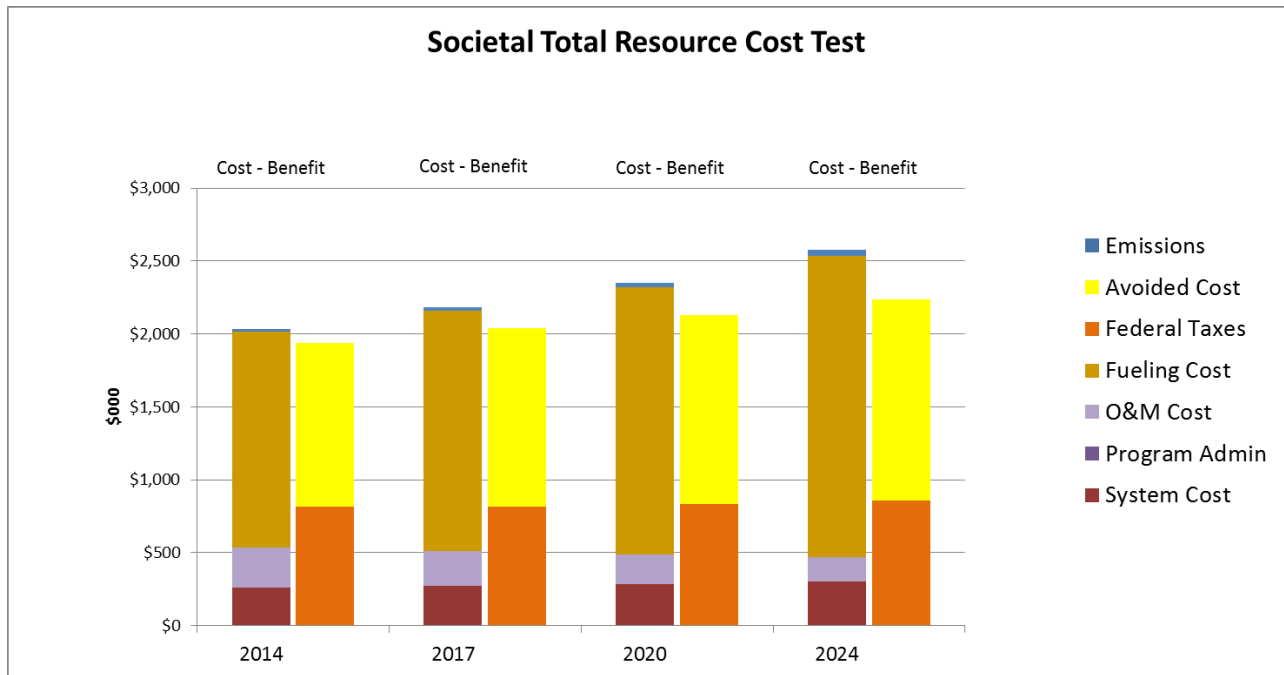


Commercial 1500 kW Directed Biogas-Fueled IC Engine STRC

Figure 6-30 is a summary of the STRC results for the larger 1.5 MW IC engine fueled by directed biogas. While the STRC benefit-cost ratio almost reaches 1 (it achieves 0.95) in 2014, the increasing fueling costs result in a declining ratio. By 2024, the STRC ratio drops to 0.87.



FIGURE 6-30: REPRESENTATIVE STRC FOR A DIRECTED BIOGAS 1500 KW IC ENGINE

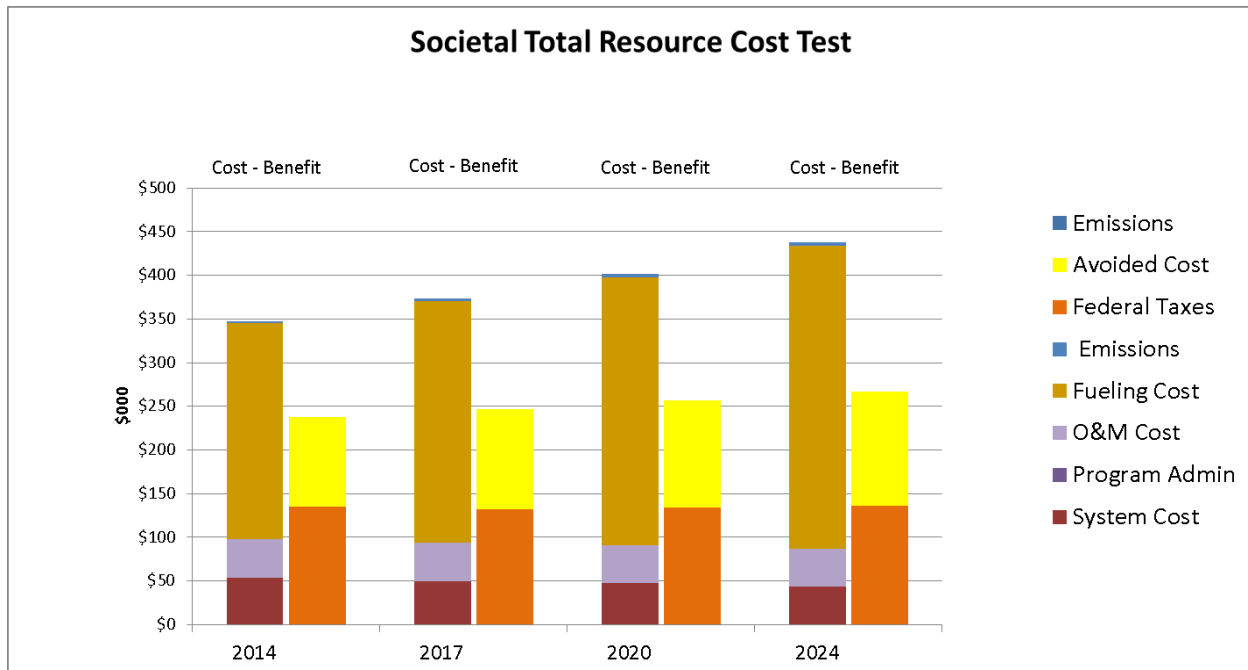


MICROTURBINE TECHNOLOGIES

Commercial 200 kW Directed Biogas-Fueled Microturbine STRC

Figure 6-31 shows the STRC results for a 200 kW microturbine fueled by directed biogas. Due to the lower power production capabilities of the lower efficiency microturbine, avoided cost benefits are less than what were seen from gas turbines or IC engines. As a result, the difference between the increasing fueling costs and the avoided electricity benefits is more pronounced. The net effect is a STRC benefit-cost ratio that starts at 0.69 in 2014 and declines to 0.61 by 2024.

FIGURE 6-31: REPRESENTATIVE SOCIETAL TOTAL RESOURCE COST TEST FOR A DIRECTED BIOGAS 200 KW MICROTURBINE



Onsite Biogas-Fueled Technologies

Biogas refers to the methane-rich gas that is produced from naturally-occurring anaerobic biological breakdown (or digestion) of organic materials such as manure or food processing wastes. Biogas is a mixture of methane, carbon dioxide, water, and a variety of other trace compounds. Depending on the source of the biogas and its associated methane content, biogas represents a renewable fuel source with an energy content of approximately half that of natural gas.¹⁹ Common sources of biogas include landfills, wastewater treatment facilities, food processing plants, and livestock operations (e.g., dairies, swine operations, etc.). Onsite biogas involves the use of biogas directly at the site where the biogas is generated.

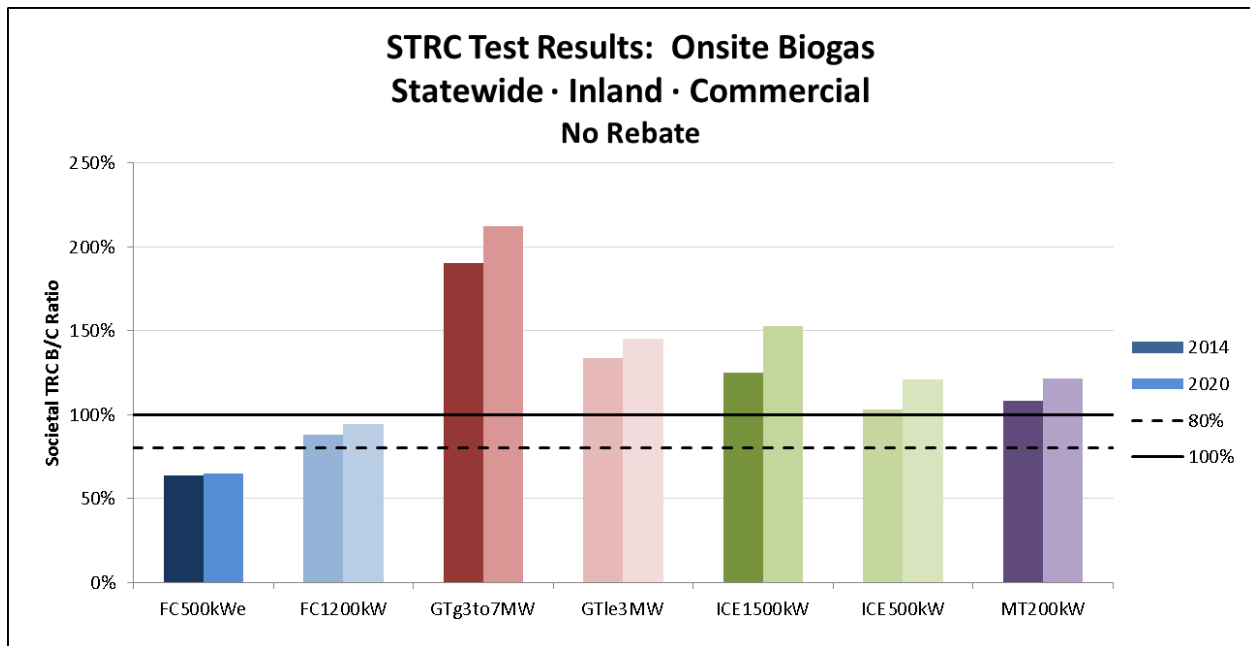
Biogas must be collected and processed before use in SGIP technologies. For our analysis, we assume the gas conditioning and cleanup processes involve the removal of water and hydrogen sulfide. Removal of hydrogen sulfide is necessary before biogas is used in IC engines, microturbines, gas turbines, and fuel cells because it is highly corrosive. This severely reduces equipment life, increases O&M costs and negatively impacts a project's revenue generation potential. For IC engine, microturbine, and gas turbine applications, hydrogen sulfide must be removed to less than 1,000 parts per million (ppm), while for fuel cells it must be reduced to less than 1 ppm by volume. A description of the approach used in estimating biogas collection and processing costs is contained in Appendix A.

¹⁹ Simons, G. and Z. Zhang, "Distributed Generation from Biogas in California," Interconnecting Distributed Generation Conference, March 21, 2001

For this study, we have assumed onsite biogas; once collected and cleaned accordingly can potentially be used with fuel cells, gas turbines, IC engines and microturbines.

Figure 6-32 shows the STRC results for onsite biogas-fueled SGIP technologies at 2014 and 2020 with no incentives.

FIGURE 6-32: STATEWIDE SOCIETAL TRC RESULTS BY ONSITE GAS FUEL (2014 AND 2020), NO INCENTIVES



With the exception of fuel cells, all the SGIP technologies using onsite biogas show STRC benefit-cost ratios in excess of 1. The STRC benefit-cost ratio for IC engines, microturbines, and large gas turbines fueled by onsite biogas are higher than technologies fueled by either natural gas or directed biogas. The STRC benefit-cost ratios for fuel cells are lower for onsite biogas than for natural gas or directed biogas because fuel cells have a higher electrical efficiency and, therefore, lower fueling costs. Running the system on onsite biogas eliminates the fueling cost while adding higher system and O&M costs. The higher electrical efficiency of fuel cells implies a lower fueling cost which compensates for the higher system and O&M costs.

Figure 6-33 and Table 6-5 provide a breakout of the STRC cost and benefit components for the different technologies fueled by onsite biogas at 2014 without incentives. Review of the cost components shows the impact of biogas clean-up costs. Fuel cells, which are particularly sensitive to contaminants in the fuel, have very high O&M costs as well as higher system costs than the other onsite biogas-fueled technologies.



FIGURE 6-33: STRC LEVELIZED COST AND BENEFIT COMPONENTS FOR ONSITE BIOGAS TECHNOLOGIES, PG&E TERRITORY, NO INCENTIVE, 2014

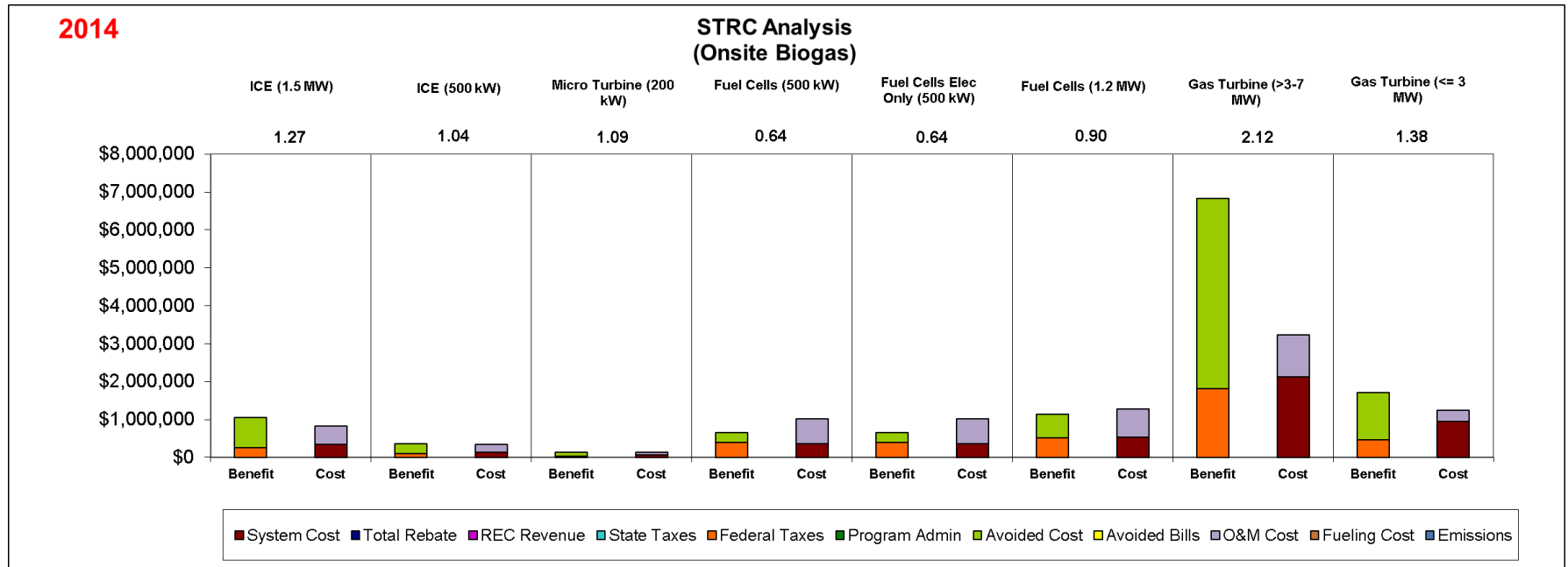


TABLE 6-5: STRC TEST LEVELIZED COST AND BENEFITS FOR ONSITE BIOGAS TECHNOLOGIES, PG&E TERRITORY, NO INCENTIVE, 2014

Cost Test 2014	ICE (1.5 MW)		ICE (500 kW)		Micro Turbine (200 kW)		Fuel Cells (500 kW)		Fuel Cells Elec Only (500 kW)		Fuel Cells (1.2 MW)		Gas Turbine (>3-7 MW)		Gas Turbine (<= 3 MW)	
	STRC		STRC		STRC		STRC		STRC		STRC		STRC		STRC	
	Benefit\$	Cost\$	Benefit\$	Cost\$	Benefit\$	Cost\$	Benefit\$	Cost\$	Benefit\$	Cost\$	Benefit\$	Cost\$	Benefit\$	Cost\$	Benefit\$	Cost\$
System Cost	--	341,371	--	136,611	--	70,229	--	354,282	--	354,282	--	527,930	--	2,121,443	--	941,218
Total Rebate	--	--	--	--	--	--	--	--	--	--	--	--	--	--	--	--
REC Revenue	--	--	--	--	--	--	--	--	--	--	--	--	--	--	--	--
State Taxes	--	--	--	--	--	--	--	--	--	--	--	--	--	--	--	--
Federal Taxes	262,533	--	104,303	--	38,287	--	388,040	--	388,040	--	512,105	--	1,813,558	--	460,557	--
Program Admin	--	--	--	--	--	--	--	--	--	--	--	--	--	--	--	--
Avoided Cost	783,812	--	261,271	--	103,389	--	263,073	--	263,073	--	631,376	--	5,012,992	--	1,253,248	--
Avoided Bills	--	--	--	--	--	--	--	--	--	--	--	--	--	--	--	--
O&M Cost	--	481,185	--	214,114	--	59,373	--	655,915	--	655,915	--	743,887	--	1,102,859	--	304,693
Fueling Cost	--	--	--	--	--	--	--	--	--	--	--	--	--	--	--	--
Emissions	--	--	--	--	--	--	--	--	--	--	--	--	--	--	--	--
Standby Charges	--	--	--	--	--	--	--	--	--	--	--	--	--	--	--	--
Total	1,046,345	822,556	365,573	350,725	141,675	129,602	651,114	1,010,197	651,114	1,010,197	1,143,481	1,271,817	6,826,550	3,224,302	1,713,805	1,245,911
Net Benefit		223,789		14,849		12,074		(359,084)		(359,084)		(128,336)		3,602,248		467,894
Ratio		1.27		1.04		1.09		0.64		0.64		0.90		2.12		1.38



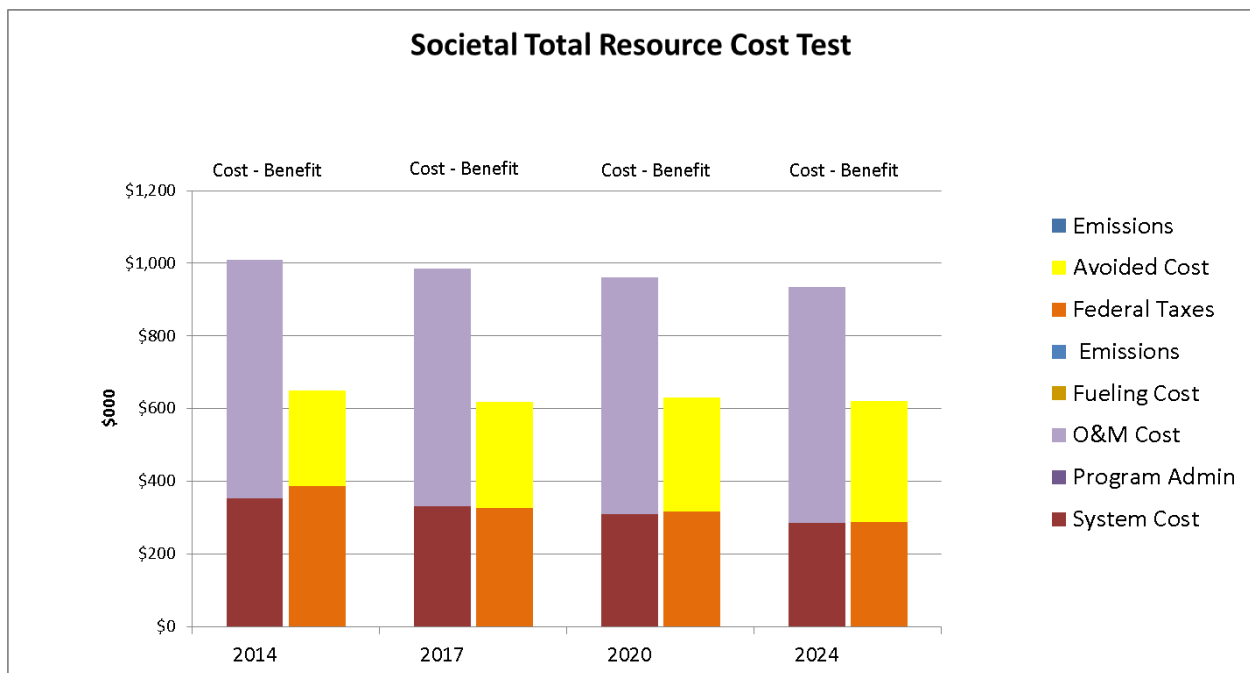
FUEL CELL TECHNOLOGIES

Onsite biogas fuel cells do not consume any natural gas. From a societal perspective, the costs associated with this technology are system capital and O&M costs. Onsite biogas fuel cells have higher capital and O&M costs than their natural gas counterparts due to the increased cost of biogas cleanup. The societal benefits from onsite biogas fuel cells are avoided electricity costs and federal tax treatment. The environmental benefits of onsite biogas technologies are captured through the electricity avoided costs.

Commercial 500 kW Onsite Biogas CHP Fuel Cell STRC

Figure 6-34 shows the societal total resource cost test results for a 500 kW onsite biogas CHP fuel cell. For this scenario, the large capital and O&M costs outweigh the societal benefits. The societal benefit-cost ratio is 0.64 for 2014 and increases to 0.66 by 2024.

FIGURE 6-34: REPRESENTATIVE SOCIETAL TOTAL RESOURCE COST TEST FOR AN ONSITE BIOGAS 500 KW CHP FUEL CELL

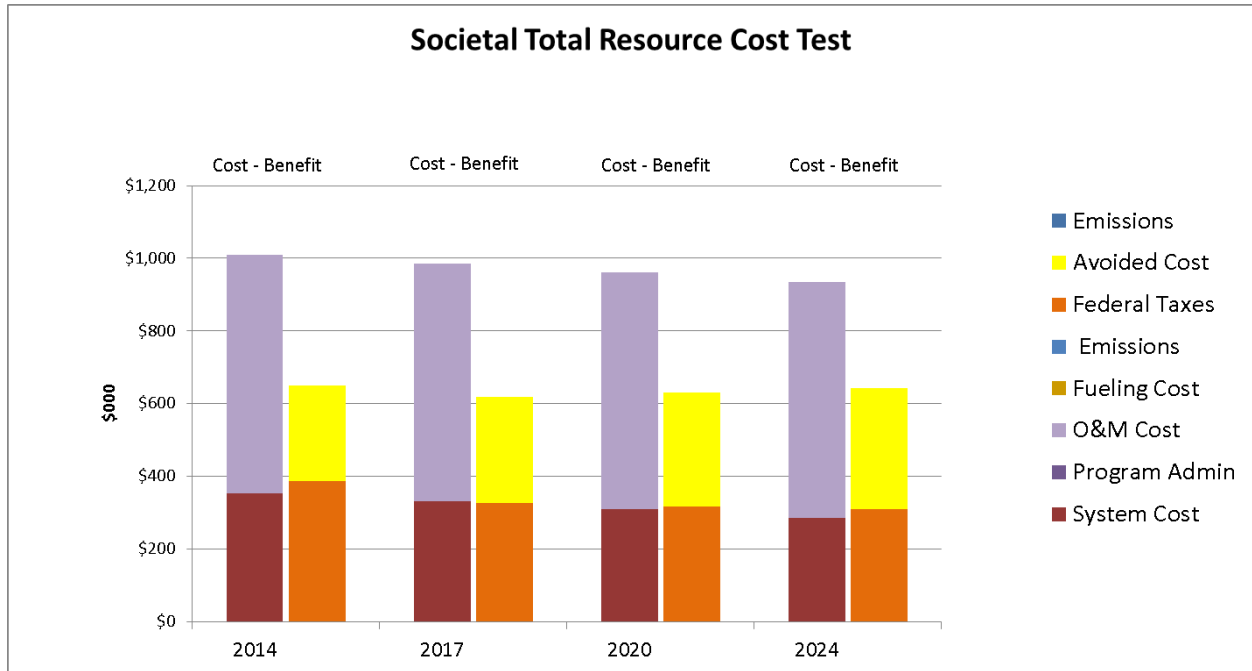


Commercial 500 kW Onsite Biogas Electric Only Fuel Cell STRC

Figure 6-35 shows the STRC results for a 500 kW onsite biogas electric-only fuel cell. The results are similar to those of the 500 kW CHP fuel cell. High capital and O&M costs outweigh the societal benefits of federal taxes and the avoided cost of electricity. In this scenario, the societal benefit-cost ratio increases from 0.64 in 2014 to 0.69 by 2024.



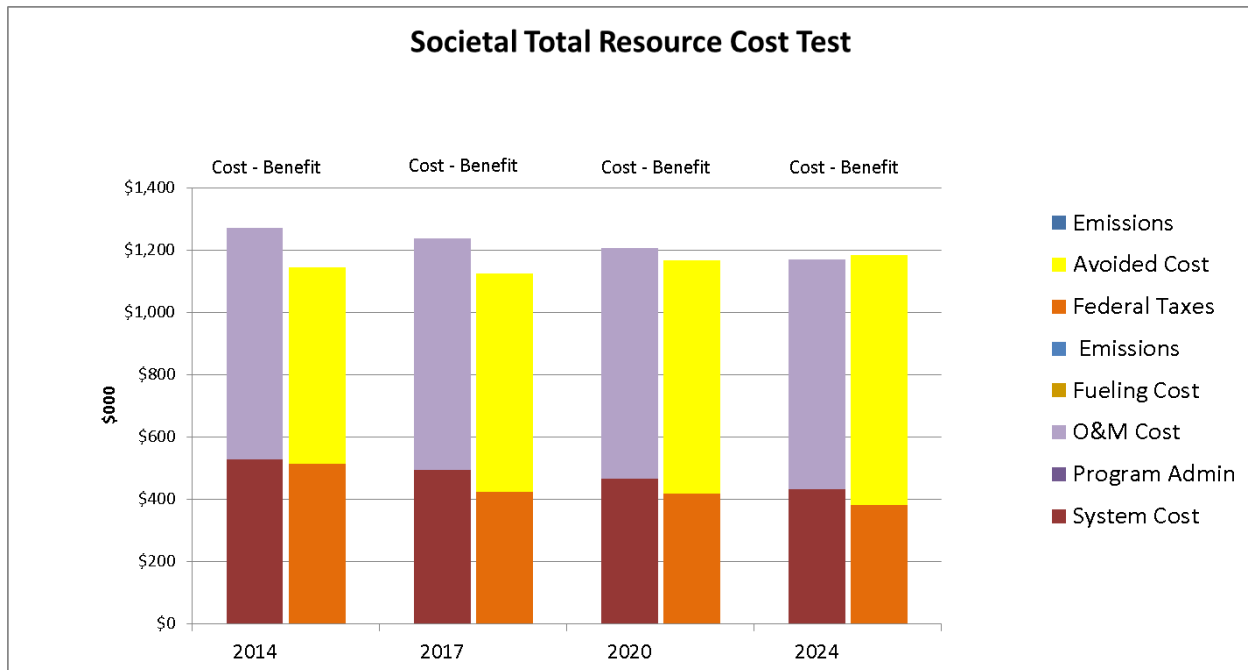
FIGURE 6-35: REPRESENTATIVE SOCIETAL TOTAL RESOURCE COST TEST FOR AN ONSITE BIOGAS 500 KW ELECTRIC-ONLY FUEL CELL



Commercial 1200 kW Onsite Biogas CHP Fuel Cell STRC

Figure 6-36 shows the STRC results for a 1,200 kW onsite biogas CHP fuel cell. In this scenario we see the societal benefit-cost ratio increase from 0.90 in 2014 to 1.01 by 2024.

FIGURE 6-36: REPRESENTATIVE SOCIETAL TOTAL RESOURCE COST TEST FOR AN ONSITE BIOGAS 1,200 KW CHP FUEL CELL



The only onsite biogas fuel cell technology that exceeds a benefit-cost ratio of 1 is the 1,200 kW case. This is most likely due to the increased impacts from larger projects and their ability to absorb the larger upfront cost. Since the capital costs for biogas capture are not strictly a function of system size, the biogas cleanup costs per Watt are lower for larger prime movers.

GAS TURBINE TECHNOLOGIES

Onsite biogas applications are typically located at dairies, waste water treatment plants or landfills. Gas turbines are usually too large for use at dairies or most waste water treatment plants. However, gas turbines have been used on larger landfill gas projects up to 7 MW in capacity.²⁰ Consequently, we examined both the 2.5 MW gas turbine and the 7 MW gas turbine sizes for onsite biogas assuming use at landfill gas to energy operations. As noted earlier, to remain consistent with SGIP Handbook guidelines, we assume onsite biogas-fueled systems are not operated as combined heat and power systems.

Commercial 2.5 MW Onsite Biogas-Fueled Gas Turbine STRC

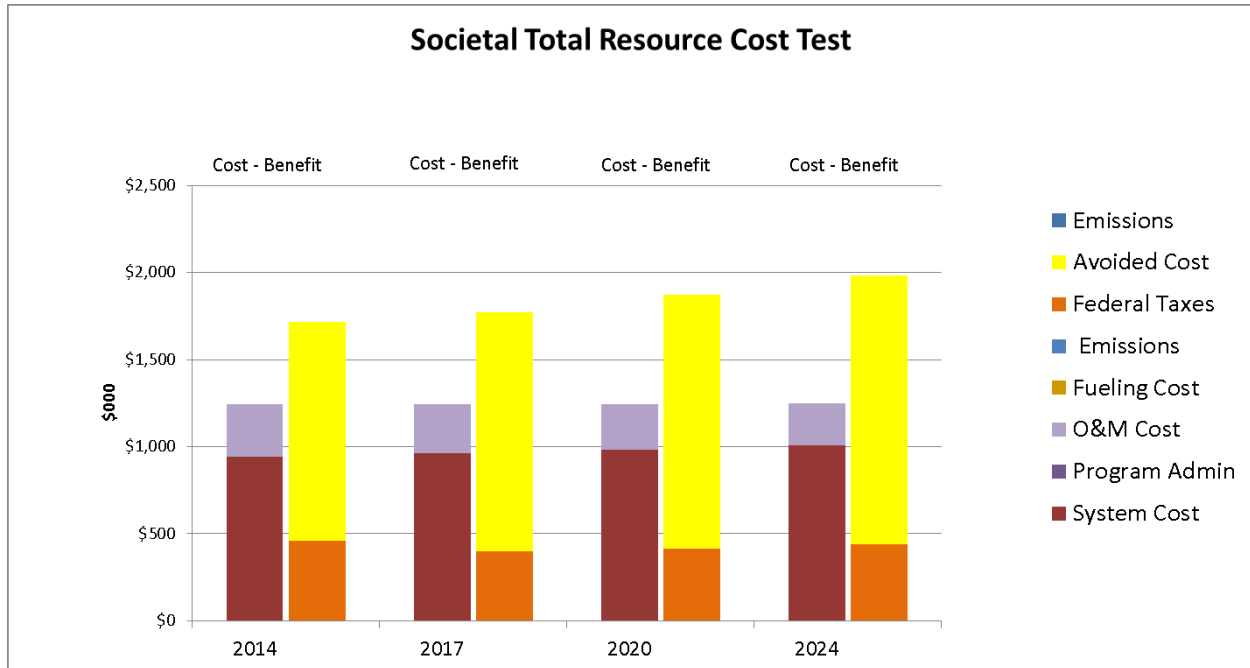
Figure 6-37 shows the STRC results for a 2.5 MW gas turbine fueled with onsite biogas without incentives from 2014 through 2024. In general, while system costs increase slightly from 2014 through 2024, O&M costs drop over the same time period. The net result is that costs remain nearly flat over the 2014 to 2024 time period. However, due to increasing electricity prices, avoided costs increase during

²⁰ For example, gas turbines in the 4 MW size range are used at the Los Angeles County Sanitation District landfill gas to energy projects. See <http://www.lacsd.org/solidwaste/swpp/energyrecovery/landfillgastoenergy/calabasasgte.asp>



the same timeframe. The net effect is that the STRC benefit-cost ratio grows steadily from 1.38 in 2014 to 1.59 by 2024.

FIGURE 6-37: REPRESENTATIVE STRC RESULTS FOR 2.5 MW ONSITE BIOGAS-FUELED GAS TURBINE

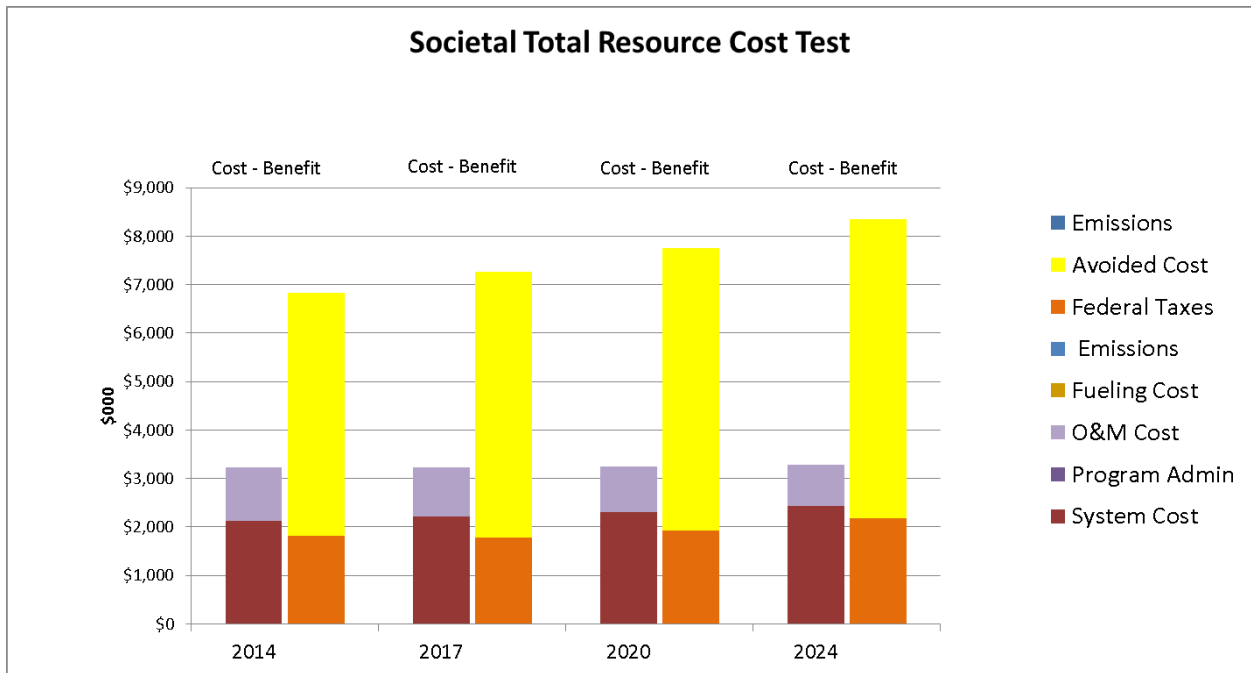


Commercial 7 MW Onsite Biogas-Fueled Gas Turbine STRC

Figure 6-38 provides the STRC results for the larger 7 MW gas turbine. Due to the larger power production capabilities of this system, the avoided electricity benefits are significantly higher than the 2.5 MW system on a per unit power basis. As a result, the STRC benefit-cost ratio starts out high in 2014 at 2.12 and continues to increase with increasing electricity prices to reach 2.54 by 2024. In addition, due to the high system costs, federal taxes become a significant benefit.



FIGURE 6-38: REPRESENTATIVE STRC RESULTS FOR 7 MW ONSITE BIOGAS-FUELED GAS TURBINE



INTERNAL COMBUSTION ENGINE TECHNOLOGIES

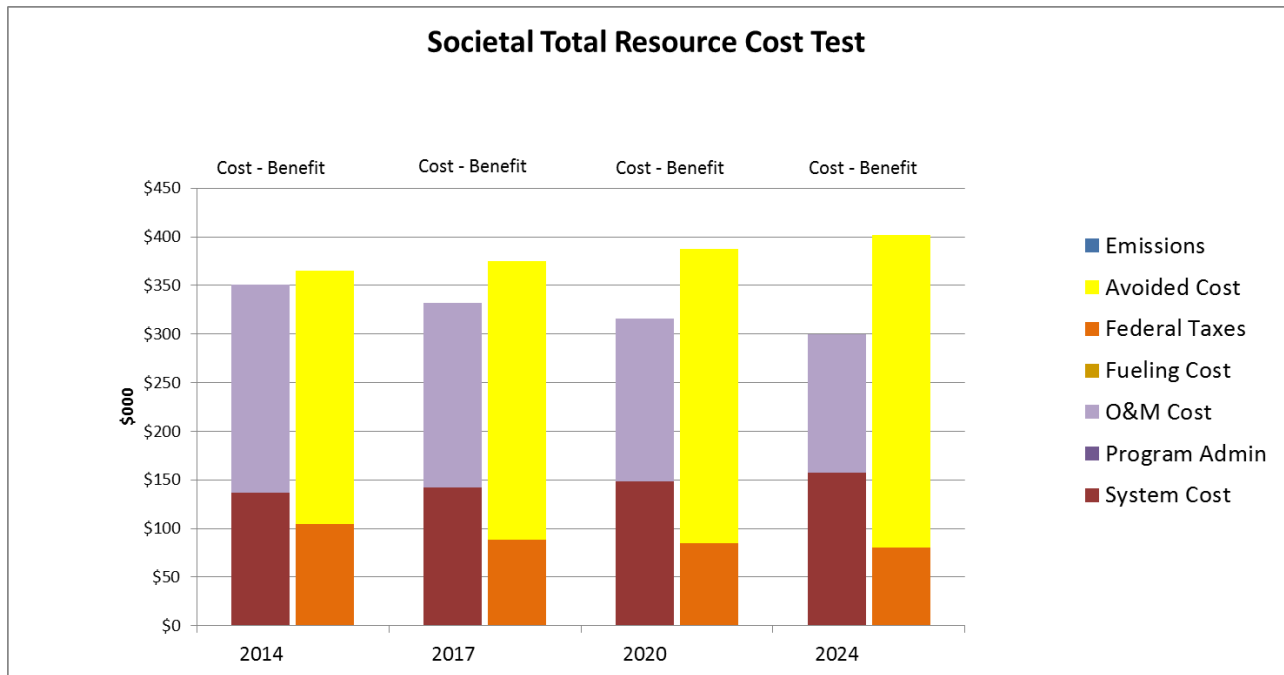
Both the 500 kW and 1.5 MW IC engine systems can be used for onsite biogas operations.

Commercial 500 kW Onsite Biogas-Fueled IC Engine STRC

Figure 6-39 provides the STRC results for a 500 kW IC engine fueled with onsite biogas without incentives from 2014 through 2024. Note that while system and O&M costs are a significant portion of the overall net benefits early on, these costs drop from 2014 through 2024. In turn, electricity prices continue to increase steadily. The net result is that the STRC benefit-cost ratio rises from 1.04 in 2014 to 1.34 by 2024.



FIGURE 6-39: REPRESENTATIVE STRC RESULTS FOR 500 KW ONSITE BIOGAS-FUELED IC ENGINE

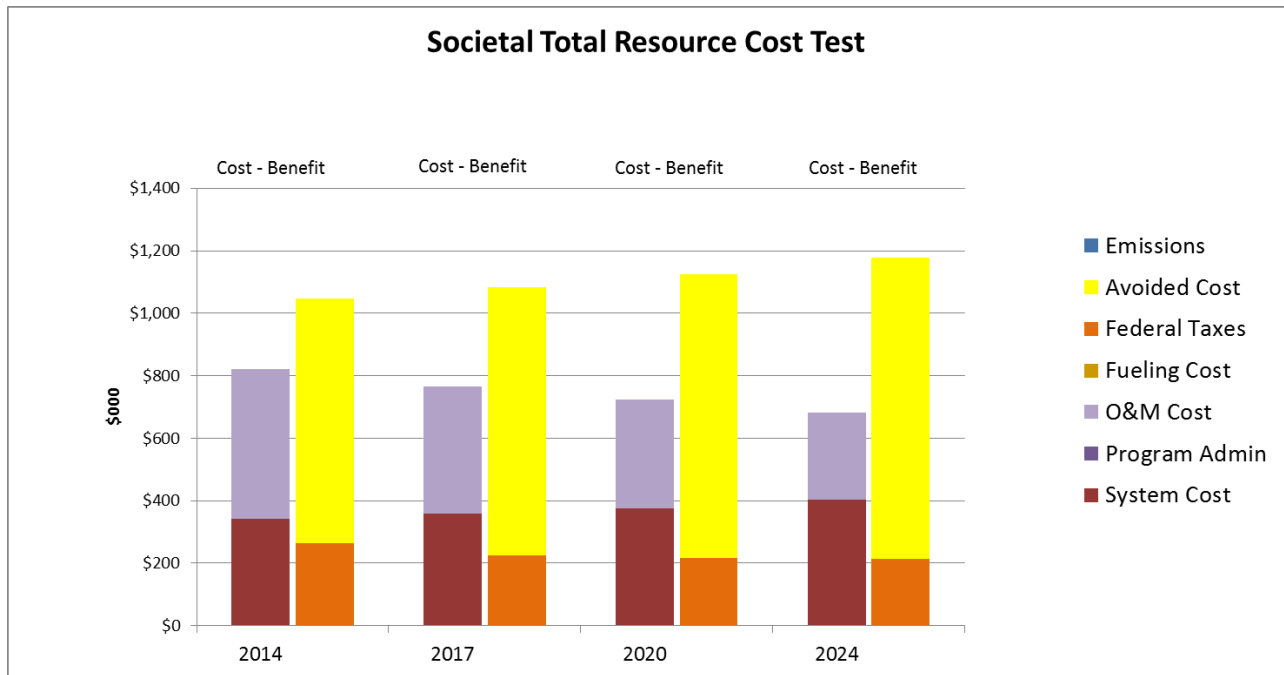


Commercial 1500 kW Onsite Biogas-Fueled IC Engine STRC

Figure 6-40 provides the STRC results for the larger 1.5 MW IC engine fueled by onsite biogas. As with other prime movers, the increased power production capability per unit of system cost pays dividends for STRC benefits. The net result is an increase in the STRC benefit-cost ratio of 1.27 at 2014 to 1.73 by 2024.



FIGURE 6-40: REPRESENTATIVE STRC RESULTS FOR 1500 KW ONSITE BIOGAS-FUELED IC ENGINE

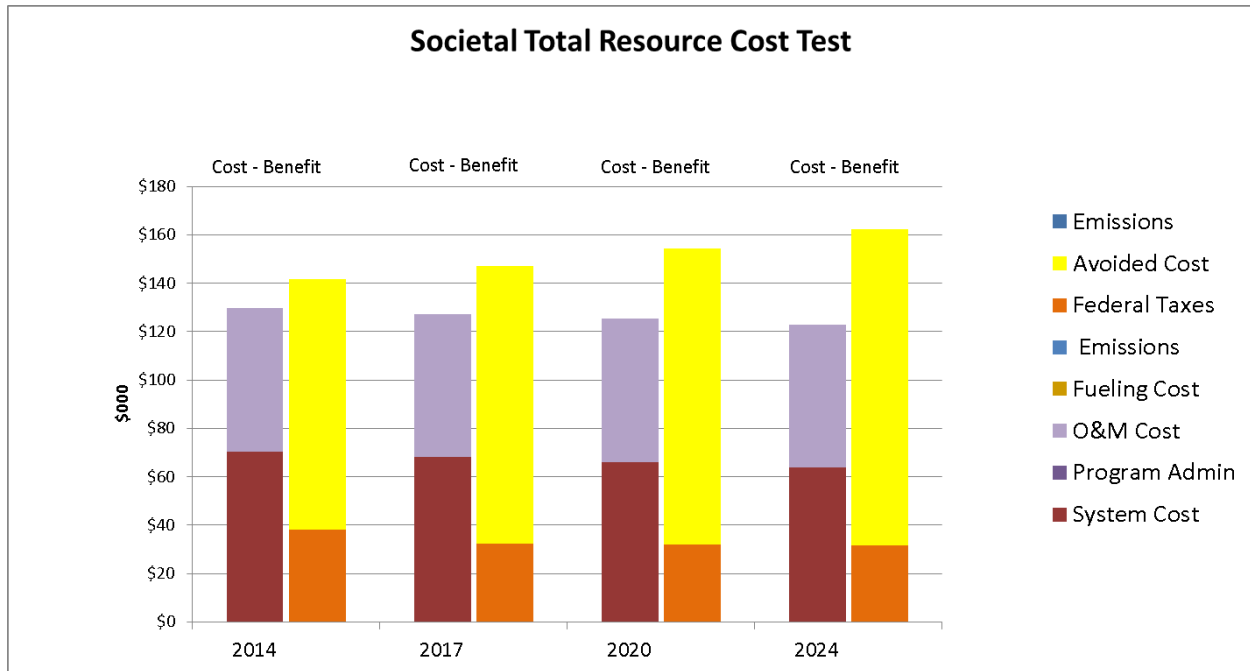


MICROTURBINE TECHNOLOGIES

Microturbines have been used in a variety of onsite biogas applications including dairies employing anaerobic digesters to waste water treatment plants and landfill gas operations.

Commercial 200 kW Onsite Biogas-Fueled Microturbine STRC

Figure 6-41 shows the STRC results for a 200 kW microturbine fueled by onsite biogas. Similar to the other technologies fueled by onsite biogas, increasing electricity prices mean higher avoided electricity prices from 2014 through 2024. Even with the relatively high O&M costs associated with onsite biogas systems, the combination of the increasing avoided costs and the lack of fueling costs are reflected in a STRC benefit-cost ratio that increases from 1.09 in 2014 to 1.32 by 2024.

FIGURE 6-41: REPRESENTATIVE STRC RESULTS FOR 200 KW ONSITE BIOGAS-FUELED MICROTURBINE


6.3 PARTICIPANT COST TEST RESULTS

Statewide Results

As indicated at the start of the results section, the Participant Cost Test examines the cost effectiveness of the SGIP technology to the participant. It can be used by PAs and other policy makers to help design an approach on incentives to be paid to the participant.

The SGIPce model generates PCT test results (i.e., the benefit-to-cost ratios) by SGIP technology, electric IOU territory, sector (e.g., commercial, residential or government/non-profit) and geographical region (“coastal” and “inland”).

Table 6-6 is a summary of the IOU-specific and statewide PCT results for 2014 by SGIP technologies deployed in the commercial sector. We have focused on commercial sector results as commercial sector applications have made up the majority of SGIP applications in the past. Statewide PCT results for the residential and government/non-profit sectors are presented in Appendix C.



TABLE 6-6: STATEWIDE SUMMARY OF COMMERCIAL SECTOR PCT RESULTS FOR 2014, NO INCENTIVES

Technology	SGIPce System Size (kW)	PG&E		SCE		SDG&E		Statewide - Equal		Statewide - Elec Sales	
		PCT 2014	MIRR	PCT 2014	MIRR	PCT 2014	MIRR	PCT 2014	MIRR	PCT 2014	MIRR
Wind Turbine											
- 1.5 MW	1,500	1.17	12.2%	0.88	8.4%	1.03	10.6%	1.02	10.4%	1.02	10.3%
Fuel Cell - Electric Only											
- Natural gas	500	0.93	9.7%	0.79	7.2%	0.86	8.4%	0.86	8.4%	0.86	8.4%
- Onsite biogas	500	0.81	6.8%	0.72	4.9%	0.78	6.0%	0.77	5.9%	0.77	5.9%
- Directed biogas	500	0.86	7.7%	0.74	5.4%	0.80	6.5%	0.80	6.5%	0.80	6.5%
Fuel Cell - CHP (i.e., w/waste heat recovery)											
- Natural gas powered	1,200	0.95	9.7%	0.79	6.1%	0.88	8.1%	0.88	8.0%	0.87	7.9%
- Onsite biogas	1,200	1.05	11.6%	0.90	8.9%	1.00	10.7%	0.98	10.4%	0.98	10.3%
- Directed biogas	1,200	0.82	5.2%	0.71	2.3%	0.78	3.8%	0.77	3.8%	0.77	3.7%
Gas Turbine - CHP											
- Natural gas powered (2500 kW)	2,500	1.12	13.0%	0.89	7.2%	1.09	12.5%	1.03	10.9%	1.01	10.3%
- Onsite biogas (2500 kW)	2,500	1.33	13.5%	1.13	11.7%	1.28	13.1%	1.25	12.8%	1.24	12.7%
- Directed biogas (2500 kW)	2,500	0.88	2.8%	0.74	-5.7%	0.87	2.2%	0.83	-0.2%	0.82	-1.1%
- Natural gas powered (7000 kW)	7,000	0.97	9.2%	0.87	6.2%	1.16	13.6%	1.00	9.7%	0.94	8.3%
- Onsite biogas (7000 kW)	7,000	1.31	15.0%	1.48	14.7%	1.70	16.2%	1.50	15.3%	1.43	15.0%
- Directed biogas (7000 kW)	7,000	0.82	-3.5%	0.72	-7.8%	0.90	3.8%	0.81	-2.5%	0.78	-4.7%

Technology	SGIPce System Size (kW)	PG&E		SCE		SDG&E		Statewide - Equal		Statewide - Elec Sales	
		PCT 2014	MIRR	PCT 2014	MIRR	PCT 2014	MIRR	PCT 2014	MIRR	PCT 2014	MIRR
Microturbine - CHP											
- Natural gas powered	200	0.96	9.5%	0.77	3.4%	0.85	5.8%	0.86	6.2%	0.87	6.4%
- Onsite biogas	200	1.35	14.2%	1.07	11.5%	1.24	13.4%	1.22	13.0%	1.21	12.9%
- Directed biogas	200	0.71	-7.7%	0.62	-100.0%	0.67	-14.2%	0.67	-40.6%	0.67	-49.9%
IC Engine - CHP											
- Natural gas powered (500 kW)	500	1.21	15.0%	0.94	8.2%	1.06	12.2%	1.07	11.8%	1.07	11.6%
- Onsite biogas (500 kW)	500	1.25	14.0%	1.00	10.4%	1.16	13.0%	1.14	12.5%	1.13	12.3%
- Directed biogas (500 kW)	500	0.89	1.6%	0.75	-12.5%	0.83	-4.3%	0.82	-5.1%	0.82	-5.4%
- Natural gas powered (1500 kW)	1,500	1.18	15.1%	0.92	6.7%	1.07	12.9%	1.06	11.6%	1.05	11.1%
- Onsite biogas (1500 kW)	1,500	1.37	15.3%	1.11	12.2%	1.26	14.3%	1.25	13.9%	1.24	13.8%
- Directed biogas (1500 kW)	1,500	0.87	-2.8%	0.73	-100.0%	0.83	-8.6%	0.81	-37.1%	0.80	-47.1%
Organic Rankine Cycle											
- 500 kW	500	1.80	15.4%	1.30	12.8%	1.59	14.6%	1.56	14.3%	1.56	14.2%
Storage											
- Med storage	30	0.59	1.5%	0.64	4.4%	0.81	7.6%	0.68	4.5%	0.64	3.4%
- Larger storage	5,000	0.58	0.5%	0.63	3.9%	0.79	6.8%	0.67	3.7%	0.63	2.6%
PRT											
- 400 kW	400	1.60	14.8%	1.17	12.0%	1.43	13.9%	1.40	13.6%	1.39	13.4%



In addition to PCT results, Table 6-6 also contains values for a modified internal rate of return (MIRR). The MIRR represents a financial evaluation of an investment's attractiveness and can be used to rank alternative investments. A higher MIRR value reflects a more attractive investment. Each IOU-specific PCT benefit-to-cost ratio has an associated MIRR value. Table 6-6 also provides statewide PCT results and statewide MIRR values. The statewide results are obtained by first averaging the IOU results arithmetically and then weighted by the percentage of electricity sales. It is important to recognize that the statewide MIRR results reflect averages of the IOU-specific MIRR results weighted by electricity sales.

Review of the PCT results in Table 6-6 indicates the following:

- » All but six of the SGIP technologies have 2014 PCT benefit-cost ratios less than or equal to 1.2. The technologies that had PCT benefit-cost ratios greater than 1.2 include:
 - > Certain SGIP technologies fueled by onsite biogas, including the 200 kW microturbine, both the 2.5 MW and 7 MW gas turbines, and the 1.5 MW IC engine
 - > Both PRT and ORC technologies, which have no fueling costs
- » SGIP technologies showing the highest PCT benefit-cost ratios are those without fueling costs. With the exception of all-electric fuel cells, this includes all SGIP technologies fueled by onsite biogas; wind energy systems; and PRT and ORC technologies.
- » PCT results are almost always highest in PG&E, followed by SDG&E and then SCE. This result tends to track the commercial sector electricity rates used for the three IOUs in the model, which corresponds to higher energy bill savings for the SGIP technologies. The exception is electric storage technologies. Due to the higher demand charges in SDG&E and the model's treatment of electric storage, the PCT ratio for electric storage is higher in SDG&E for electric storage than it is in the PG&E or SCE areas.
- » Regardless of the IOU service territory, the SGIP technologies showing the highest PCT ratios are those without fueling costs. With the exception of all-electric fuel cells, this includes all SGIP technologies fueled by onsite biogas; wind energy systems; PRT and ORC technologies.

The following sections provide the results of the PCT/MIRR incentive calculations for each grouping of SGIP technologies. As with the STRC results, we have focused only on results specific to the commercial sector. In addition, we provide results only for one electric IOU service territory (PG&E) in order to reduce the number of tables and graphs. Results from the SCE and SDG&E service territories will be different due to differences in electricity and gas rates. However, the results for PG&E provide good representation of the types of findings and trends that would be applicable in the other electric IOU service territories.

Non-Fuel Technologies

Non-fuel technologies consist of advanced energy storage, wind energy systems, pressure reduction turbines and waste heat to power systems.

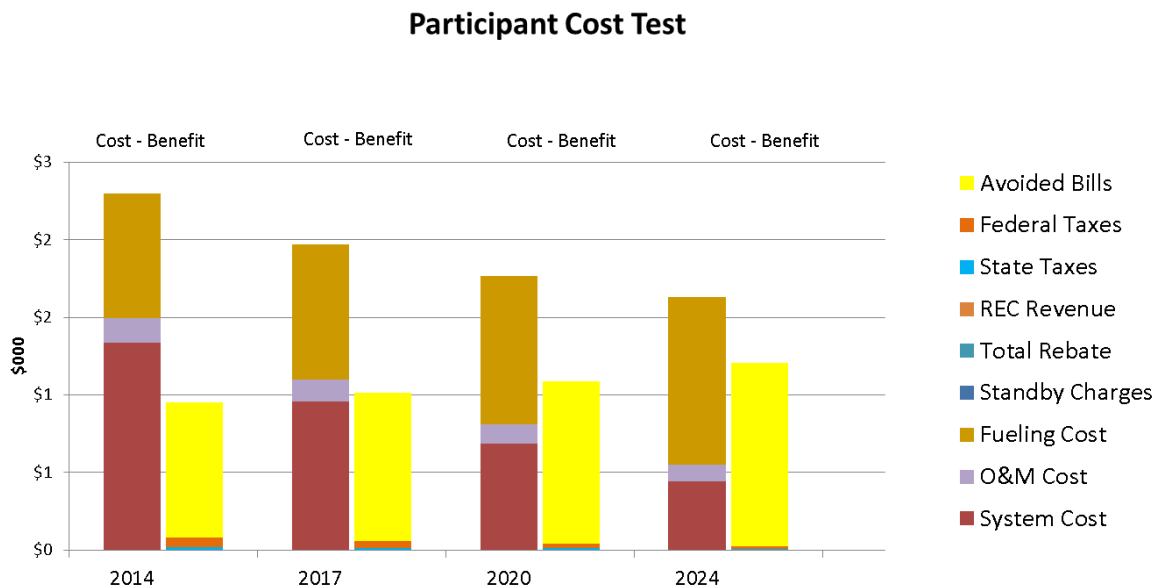


ADVANCED ENERGY STORAGE PARTICIPANT RESULTS

Residential 5 kW Storage Participant Cost Test

The PCT results for a 5 kW residential system (with no incentives) are shown in Figure 6-42. This system is assumed to be on a TOU rate. Benefits rise some from 2014 to 2024 with rising electricity prices, while costs steadily decline. However, the benefit-to-cost ratio stays below 1.0 by 2024, only reaching 0.67 for PG&E territory. SDG&E yields slightly better results but still only reaches a benefit-to-cost ratio of 0.79 in 2024. One of the primary benefits of standalone behind-the-meter AES are reduced demand charges. However, since California residential customers are not currently subject to demand charges, AES faces a challenging proposition to be cost effective in this space. Residential customers may be subject to demand charges in the future²¹, so the value proposition for storage could change dramatically. Backup power is one of the primary selling points for residential AES, but that benefit is not quantified as part of this study. Note that system costs are the primary contributor to the declining costs and drop by nearly two thirds between 2014 and 2024. Fueling (charging) costs rise slightly from 2014 to 2024, as do avoided bills. For residential standalone storage systems, federal and state taxes have minimal impact.

FIGURE 6-42: REPRESENTATIVE PARTICIPANT TEST RESULT FOR 5 KW RES STORAGE SYSTEM



These results could be significantly different under a situation where electricity rates increased dramatically (for example under a critical peak pricing program) or the value of the offset electricity was significantly higher than avoided retail rates. In addition, as Lithium Ion battery technology advances, costs of storage may decrease considerably faster (or slower) than what we have modeled. Finally, regulatory proceedings impacting net energy metering, demand response, residential rates, energy

²¹ <http://www.sfchronicle.com/business/article/California-electricity-prices-to-rise-for-those-6353950.php>

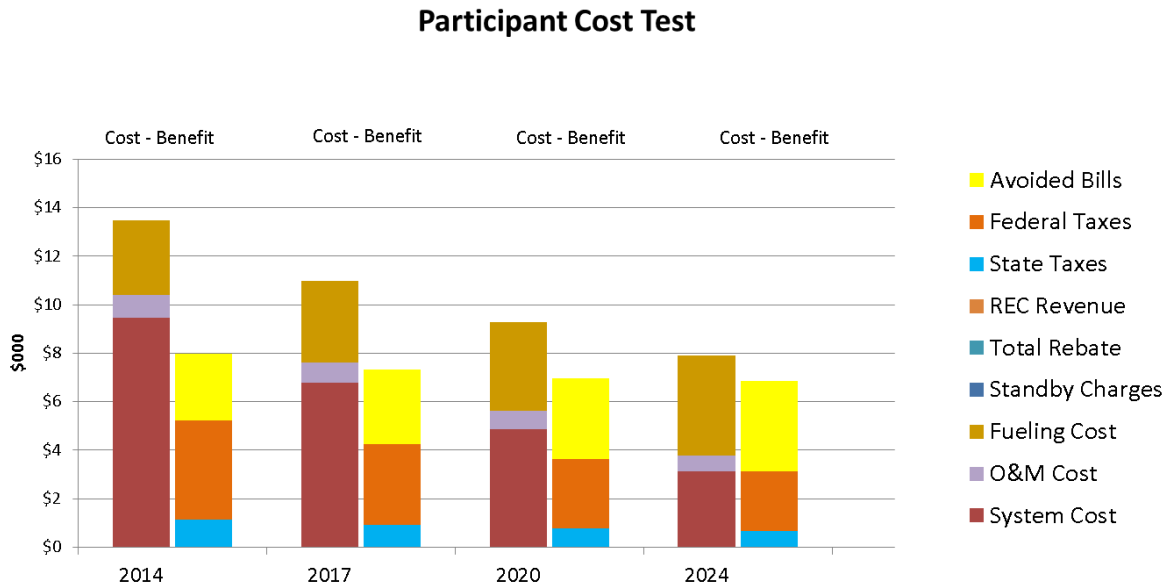


storage procurement, and distributed resource plans could significantly change the benefits available from storage.

Commercial 30 kW Participant Cost Test

Figure 6-43 displays the participant cost test results for the 30 kW storage system. Like the smaller storage system, benefits remain relatively flat and in fact decrease slightly from 2014 through 2024. Benefits are from tax deductions (from depreciation, interest, and lower operating income) and bill savings (avoided energy and demand charges). The decrease is due to the falling price of the systems that drives a corresponding drop in tax savings to the owner. Avoided bills (energy and demand) rise slightly as electricity prices rise. The net result is that without incentives, the 30 kW storage system starts in 2014 with a benefit-to-cost ratio of 0.59 and only reaches a participant benefit-to-cost ratio of 0.87 by 2024 in the chosen representative area of PG&E Inland.

FIGURE 6-43: REPRESENTATIVE PARTICIPANT TEST RESULT FOR 30 KW STORAGE SYSTEM

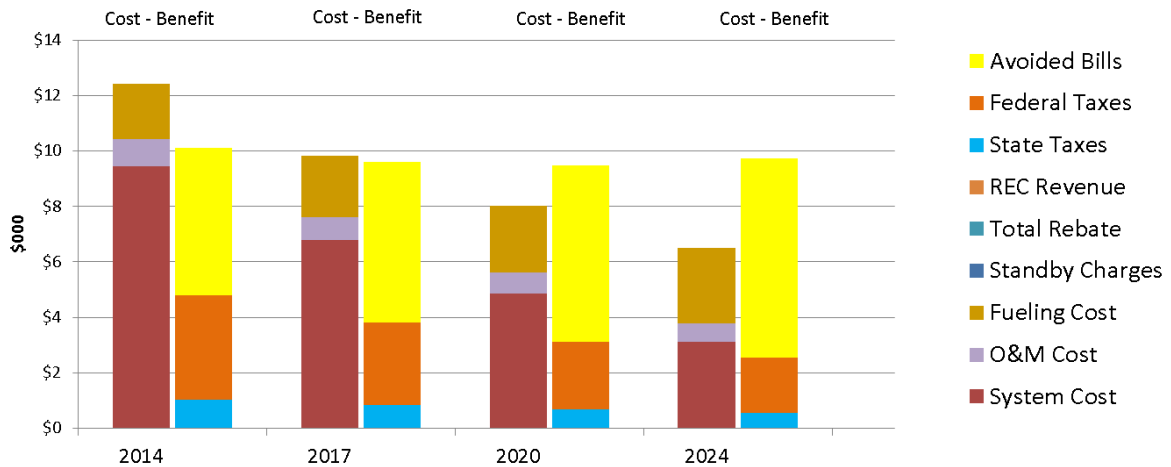


However, under SDG&E rates, the same 30 kW system becomes cost effective before 2020 and reaches a benefit-cost ratio of 1.50 in 2024. Figure 6-44 shows PCT results for SDG&E. The difference to PG&E is due to higher demand charges in SDG&E. Systems in SCE fall somewhat in between those in PG&E and SDG&E and reach a participant benefit cost ratio of 1.11 by 2024.



FIGURE 6-44: SDG&E PARTICIPANT TEST RESULT FOR 30 KW STORAGE SYSTEM

Participant Cost Test



A breakdown in the cost and benefit components for a 30 kW storage system is provided in Table 6-7. Fueling costs represent the cost of charging the system. We assume the system charges at off-peak electricity rates but that these rates continue to increase over time. In addition, the benefit from avoided bills rises over time but is limited relative to the cost of charging the system. As with the smaller storage system, the participant results could change significantly with different electricity prices, charging performance or system cost.

TABLE 6-7: BREAKDOWN OF COSTS AND BENEFITS FOR 30 KW STORAGE SYSTEM PARTICIPANT TEST IN SDG&E TERRITORY

PCT Costs	2014	2017	2020	2024
System Cost	\$9,451	\$6,780	\$4,863	\$3,123
O&M Cost	\$971	\$839	\$744	\$658
Fueling Cost	\$2,024	\$2,213	\$2,421	\$2,730
Total Costs	\$12,4462	\$9,832	\$8,029	\$6,511
Total Rebate	--	--	--	--
REC Revenue	--	--	--	--
State Taxes	\$1,038	\$825	\$678	\$555
Federal Taxes	\$3,747	\$2,976	\$2,446	\$2,003
Avoided Bills	\$5,325	\$5,823	\$6,369	\$7,181
Total Benefits	\$10,110	\$9,624	\$9,493	\$9,739
Net Benefits	\$(2,336)	\$(208)	\$1,464	\$3,228
Ratio	0.81	0.98	1.18	1.50



Figure 6-45 shows the impact of changing incentive levels for AES nominally at 30 kW in the representative area of PG&E, Inland. Rebates are shown in terms of \$ per Watt. An incentive²² of \$2.49 per Watt provides an MIRR of 10%; higher rebates are not calculated since the total rebate amount would exceed the cost of the system. Systems installed at sites with significantly shorter and higher peaks than the simulated system could be more cost effective.

FIGURE 6-45: PCT RESULTS FOR 30 KW STORAGE (PG&E)

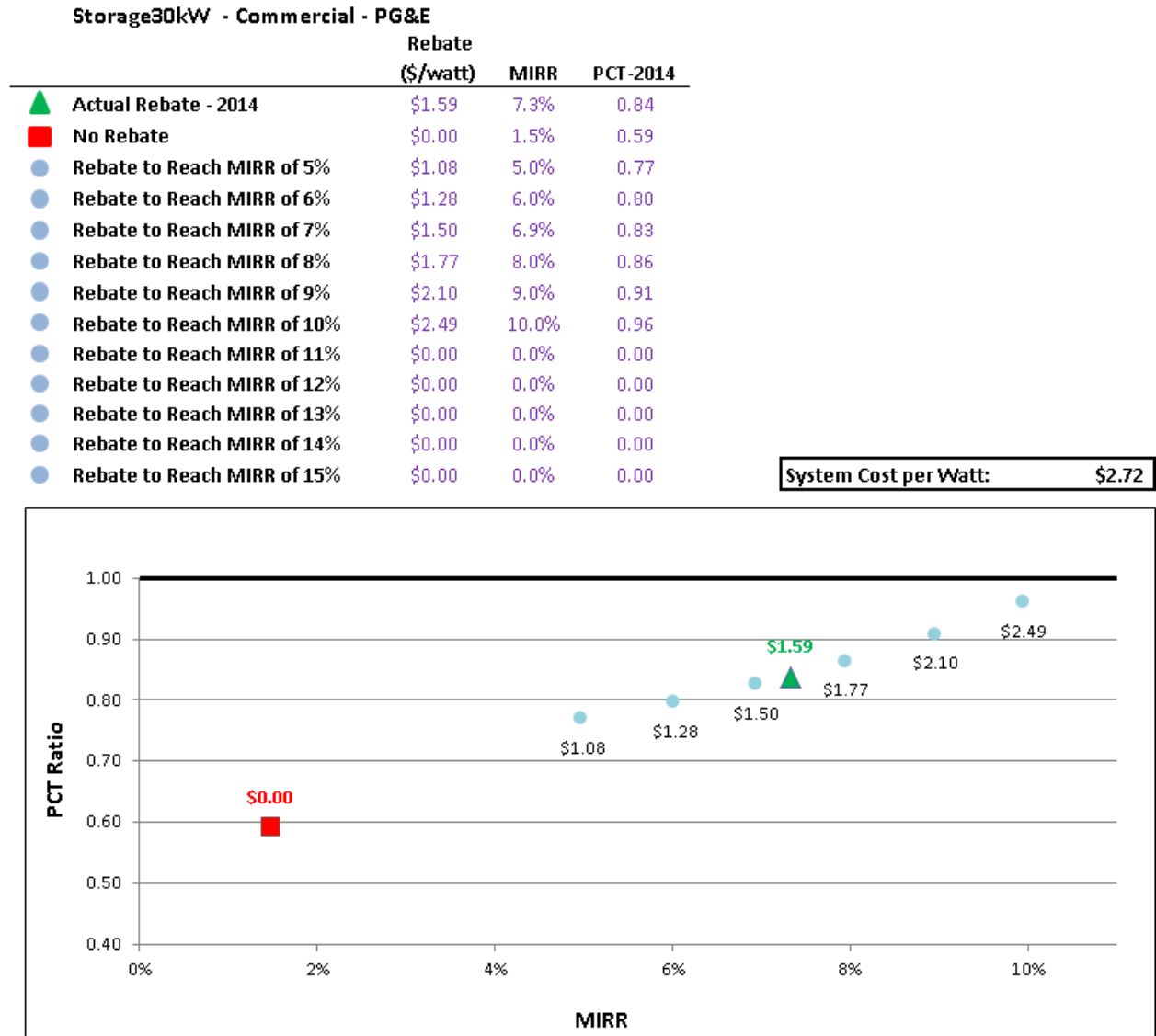


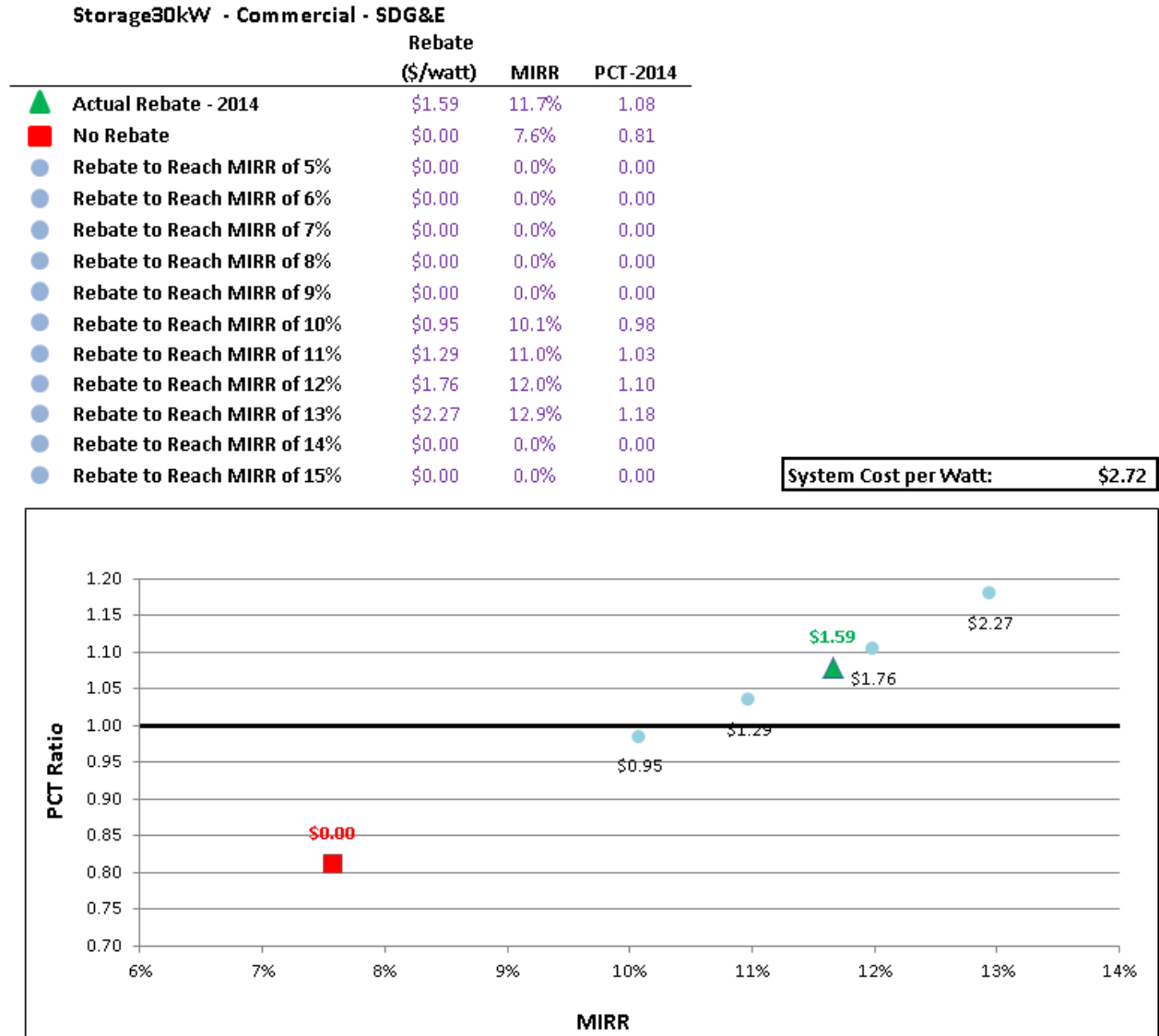
Figure 6-46 shows the impact of changing incentive levels for AES nominally at 30 kW in the SDG&E territory. As shown previously in Figure 6-44, storage without incentives in SDG&E is closer to being cost effective than in PG&E territory for the chosen rates and operating conditions. The existing incentive

²² This incentive as structured as a hybrid PBI per current SGIP program rules.



provides an MIRR of 11.7% and has a 2014 PCT ratio greater than 1, at 1.08, meaning that with the current incentives, the typical system is cost effective.

FIGURE 6-46: PCT RESULTS FOR 30 KW STORAGE (SDG&E)



Commercial 5 MW Participant Cost Test

Figure 6-47 displays the PCT results for the larger 5 MW kW storage system. Like the smaller storage systems, benefits rise slightly from 2014 through 2024. Reductions in cost are driven by reductions in installed costs, and benefits rise due to increasing electricity bills. The net result is that without incentives, the 5 MW storage system starts with a benefit-to-cost ratio of 0.58 in 2014 and reaches a benefit-to-cost ratio of 0.80 by 2024 in the representative area of PG&E Inland.



FIGURE 6-47: REPRESENTATIVE PARTICIPANT COST TEST RESULT FOR 5 MW STORAGE SYSTEM

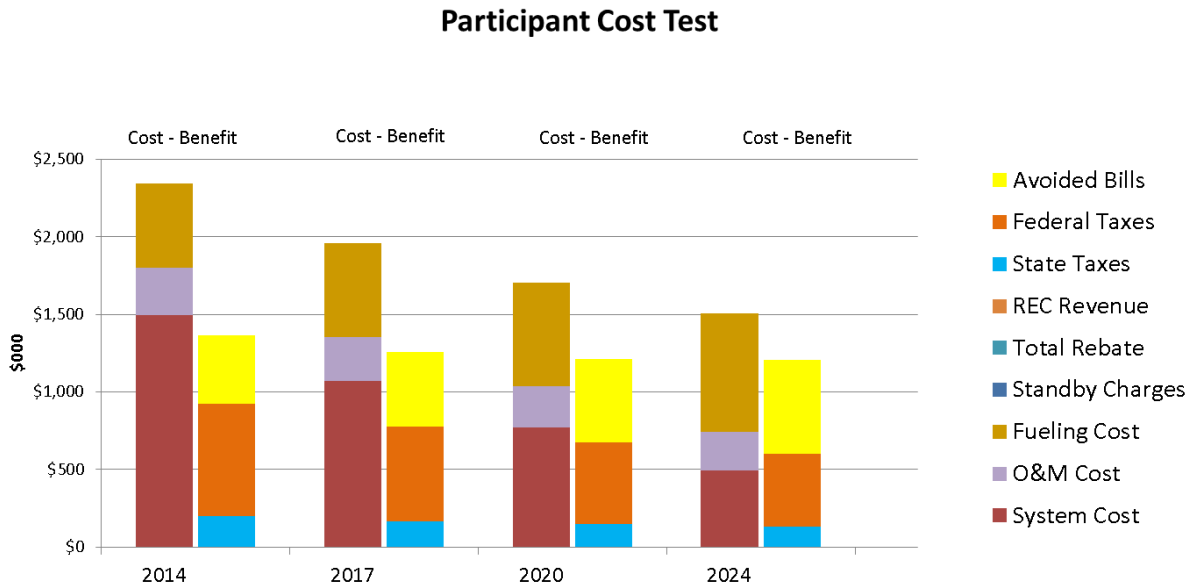


Figure 6-48 shows the PCT results for the same 5 MW system in SDG&E territory, where the system becomes cost effective before 2020 and reaches a benefit cost ratio of 1.34 in 2024. This difference to the PG&E representative system is due to higher demand charges for the SDG&E rate. Systems in SCE fall somewhat in between and reach a participant benefit cost ratio of 1.03 by 2024.

FIGURE 6-48: SDG&E PARTICIPANT COST TEST RESULT FOR 5 MW STORAGE SYSTEM

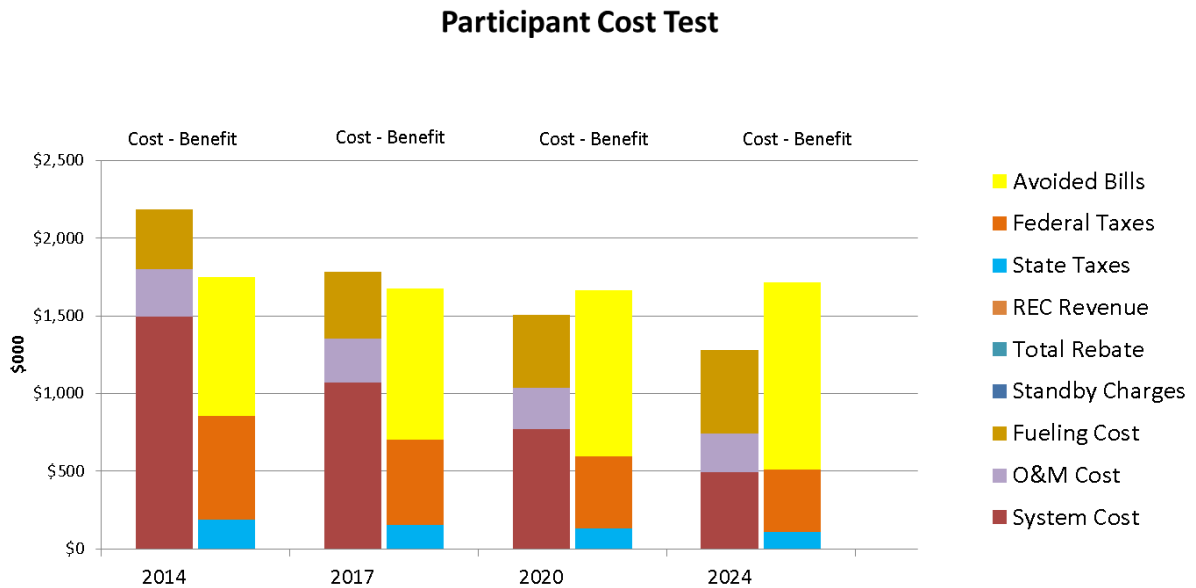
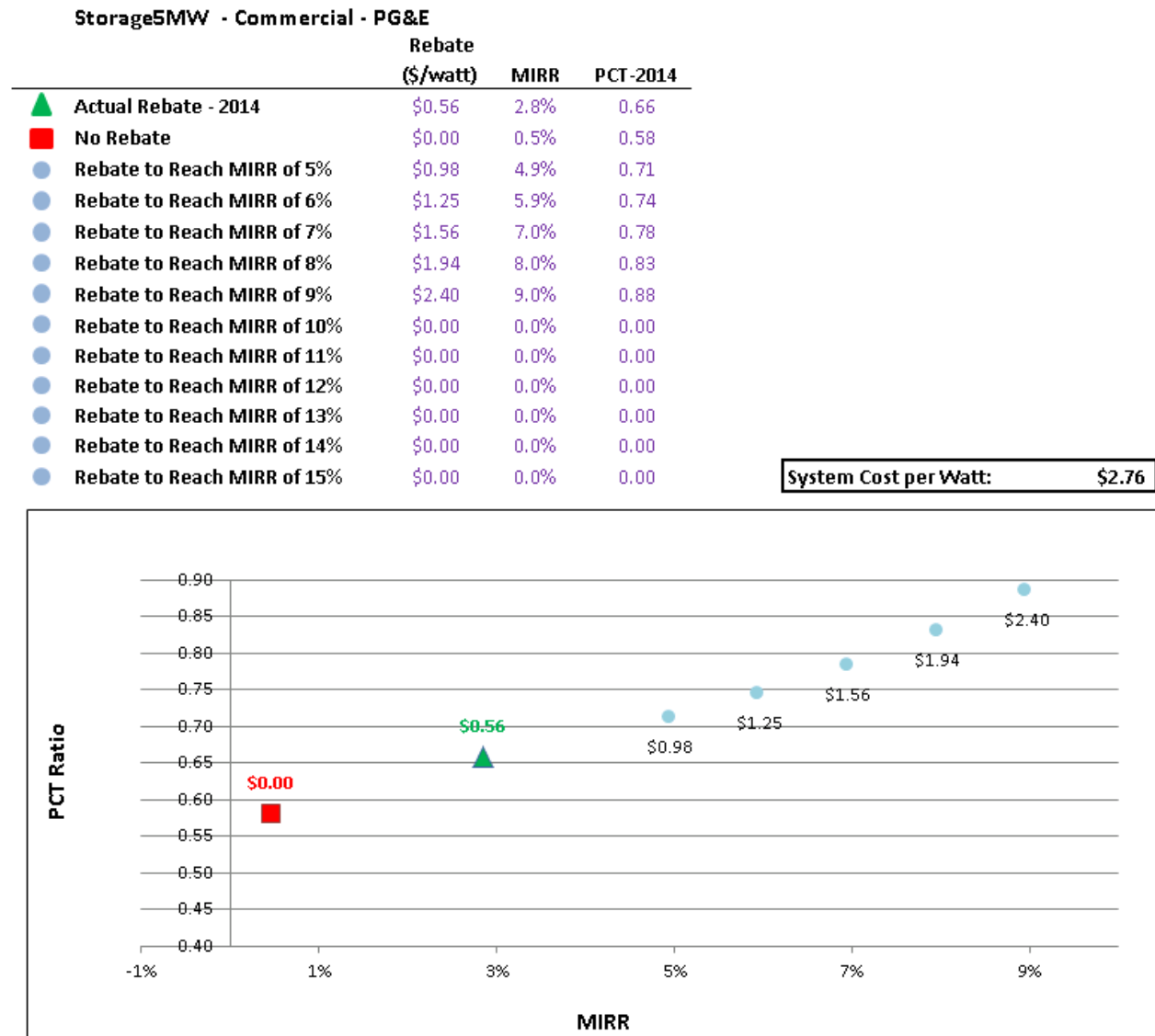




Figure 6-49 shows the impact of changing incentive levels for AES nominally at 5 MW in the representative area of PG&E, Inland. Rebates are shown in terms of kWh, and based on the expected discharge of the 5 MW (20 MWh) system. An incentive of \$2.40 per Watt provides an MIRR of 9%; higher rebates are not calculated since they would exceed the cost of the system.

FIGURE 6-49: PCT RESULTS FOR 5 MW STORAGE (PG&E)



Like 30 kW systems, a 5 MW system in SDG&E territory has substantially better economics. However, due to the incentive being limited beyond 1 MW, a 5 MW system with incentive would only see a PCT ratio of 0.88 in 2014.



WIND ENERGY PARTICIPANT RESULTS

We evaluated wind energy systems at two representative sizes: a 50 kW system that could be used in agricultural settings and a 1.5 MW system that could be used by large host sites or by third party developers.

Residential 50 kW Wind Participant Cost Test

Although we classify the 50 kW wind energy system as a residential application, it could be used in commercial settings.

Figure 6-50 presents a summary of the PCT results for a representative 50 kW wind energy system deployed in the PG&E service area. The results reflect the PCT benefit-cost results without incentives from 2014 through 2024. High system costs provide the biggest challenge to the system being cost effective to participants without incentives. However, increasing prices of electricity provide growing levels of avoided bills. As a result, the benefit-cost ratio improves from 0.69 in 2014 to 0.96 by 2024.

Earlier in this section, we examined STRC results for the 50 kW wind system. That analysis showed this size wind turbine had a low STRC benefit-cost ratio; approximately 0.27. Consequently, while a 50 kW wind turbine becomes increasingly more cost effective to participants, it is less cost effective to society.

FIGURE 6-50: REPRESENTATIVE PARTICIPANT TEST RESULT FOR 50 KW WIND SYSTEM

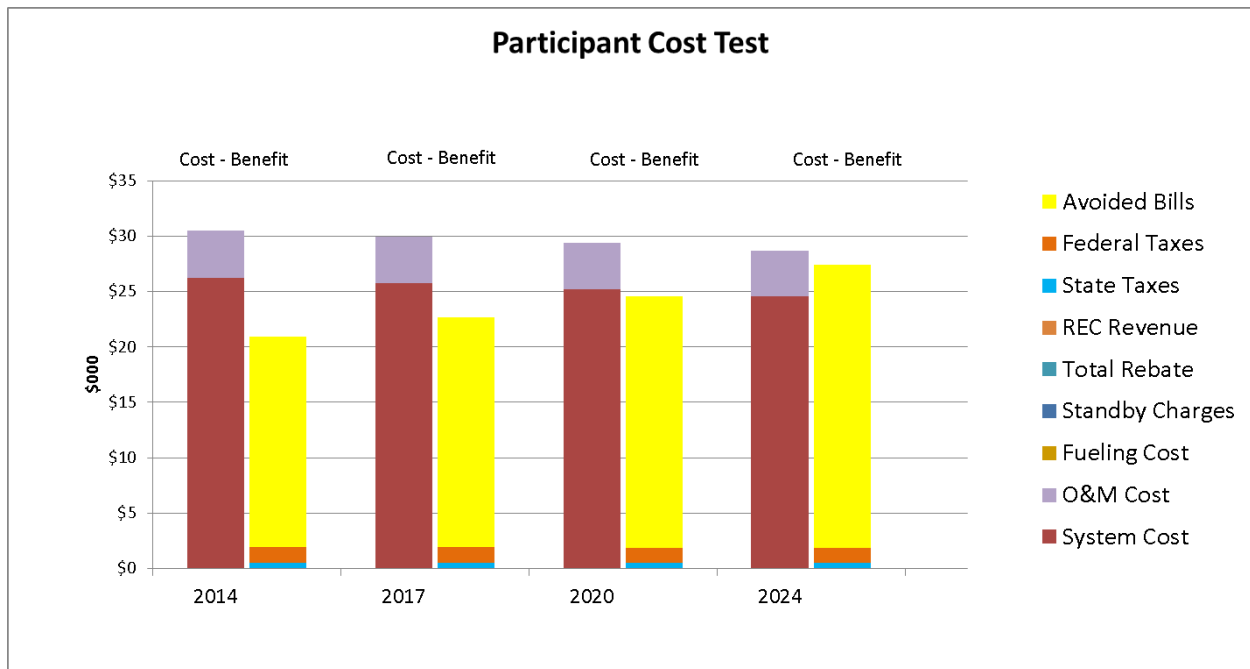


Figure 6-51 shows results of an MIRR analysis for the 50 kW wind turbine system. At actual incentive levels associated with the SGIP in 2014, the MIRR for the project is 0.5%; reflecting the low cost effectiveness to the participant even with the incentive. As shown in the chart, substantial increases in the incentive level (i.e., up to \$6.23/Watt) would be needed to bring the MIRR up to levels close to 10% or higher.

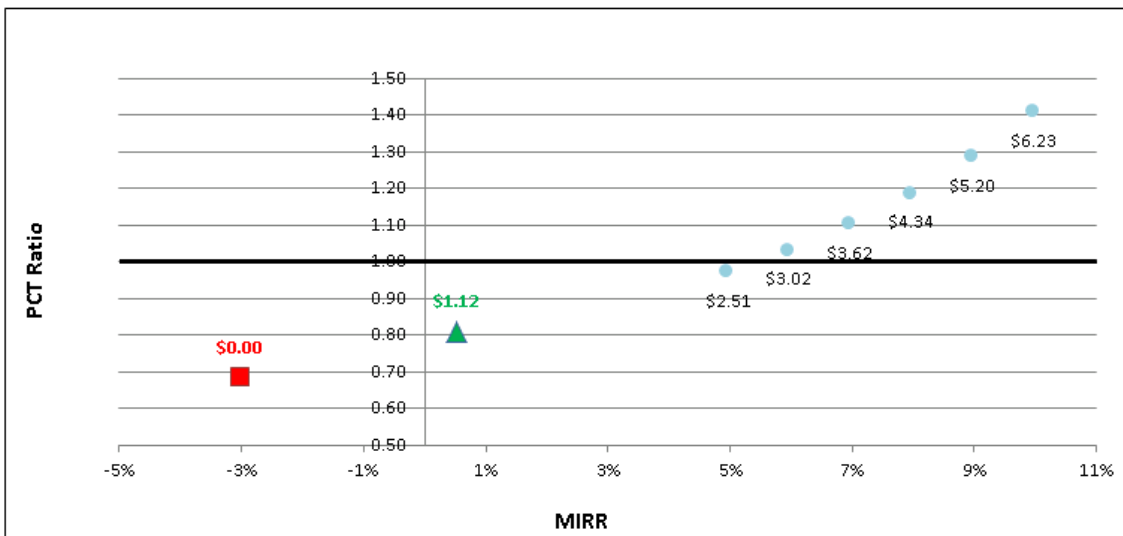


FIGURE 6-51: PCT RESULTS FOR 50 KW WIND

WD50kW - Residential - PG&E

	Rebate (\$/watt)	MIRR	PCT-2014
▲ Actual Rebate - 2014	\$1.12	0.5%	0.81
■ No Rebate	\$0.00	-3.0%	0.69
● Rebate to Reach MIRR of 5%	\$2.51	5.0%	0.97
● Rebate to Reach MIRR of 6%	\$3.02	6.0%	1.03
● Rebate to Reach MIRR of 7%	\$3.62	7.0%	1.10
● Rebate to Reach MIRR of 8%	\$4.34	8.0%	1.19
● Rebate to Reach MIRR of 9%	\$5.20	9.0%	1.29
● Rebate to Reach MIRR of 10%	\$6.23	10.0%	1.41

System Cost per Watt: **\$6.41**



Commercial 1,500 kW Wind Participant Cost Test

Figure 6-52 shows representative PCT results for a 1,500 kW wind turbine installed in the PG&E service area without incentive. The PCT benefit-cost ratio exceeds 1 for all years examined and remains relatively flat at values ranging from 1.11 to 1.14. While avoided electricity benefits increase each year, O&M costs raise at the same level. In addition, we found wind energy systems at this size range to have a relatively low learning curve. As a result, while system costs for the generation of wind turbines installed between 2014 and 2020 decline, they decline at a lesser degree in comparison to the increasing O&M costs.

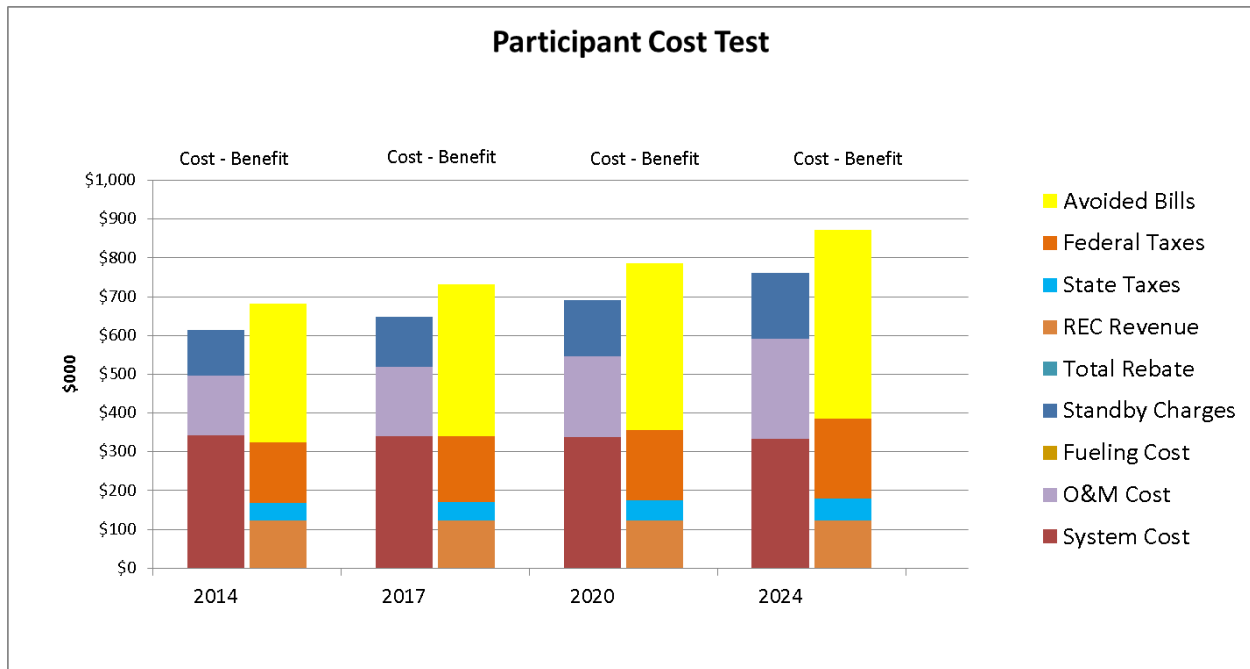
FIGURE 6-52: REPRESENTATIVE PARTICIPANT TEST RESULT FOR 1500 KW WIND SYSTEM


Figure 6-53 shows the impact of changing incentive levels for the representative 1.5 MW wind turbine located in the inland area of PG&E’s service territory. In the case of this 1.5 MW wind system, the project shows a PCT ratio of 1.1 without an incentive and realizes an MIRR of 11.7%. At the incentive level expected in 2014 of \$0.37 per Watt, the project’s MIRR increases to 12.5%. If 13% MIRR was a goal, this project would need to receive an incentive equal to \$0.68/Watt; over twice the 2014 incentive level. If 10% MIRR was the goal, this project would not qualify for an incentive; having achieved a MIRR of 11.7% without any incentive.

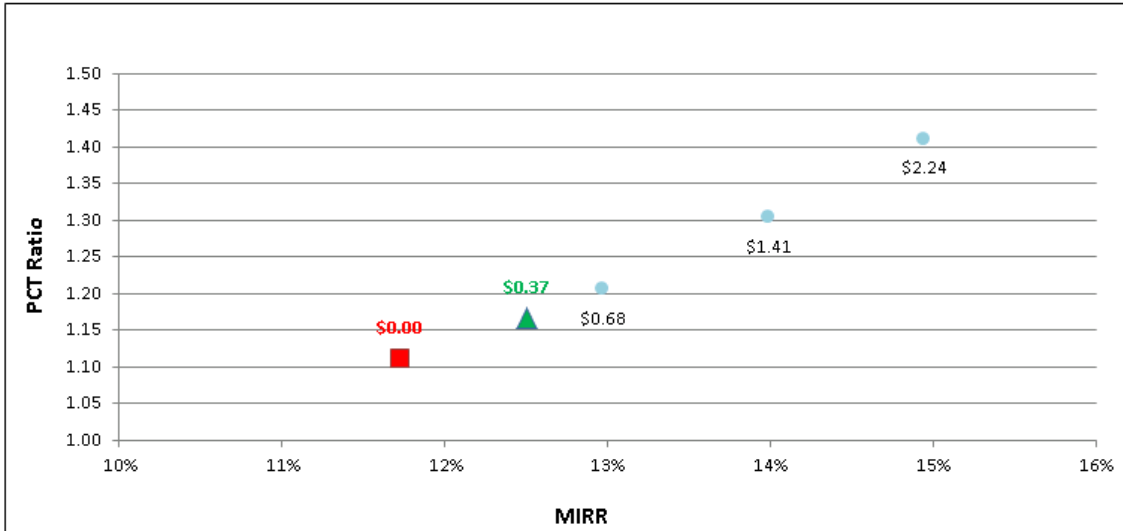


FIGURE 6-53: PCT RESULTS FOR 1500 KW WIND

WD1500kW - Commercial - PG&E

	Rebate (\$/watt)	MIRR	PCT-2014
▲ Actual Rebate - 2014	\$0.37	12.5%	1.17
■ No Rebate	\$0.00	11.7%	1.11
● Rebate to Reach MIRR of 13%	\$0.68	13.0%	1.21
● Rebate to Reach MIRR of 14%	\$1.41	14.0%	1.30
● Rebate to Reach MIRR of 15%	\$2.24	14.9%	1.41

System Cost per Watt: \$2.27

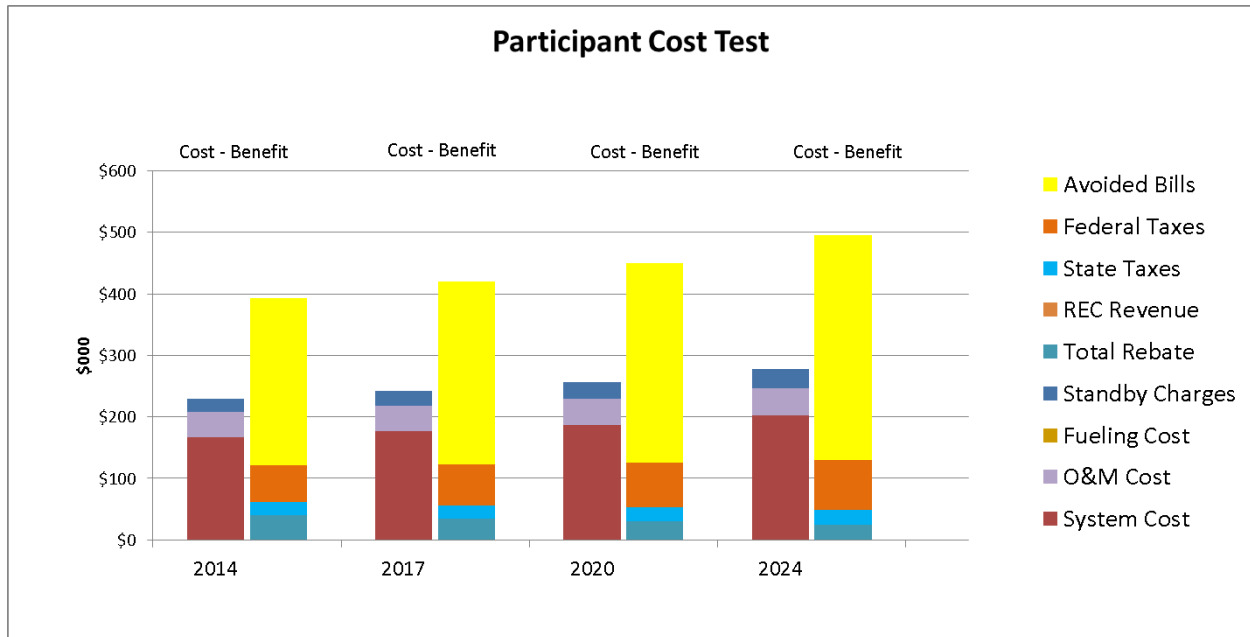


PRESSURE REDUCTION TURBINES

Figure 6-54 displays the participant cost test results for the 400 kW PRT system. The benefit-cost ratio starts at 1.71 in 2014 and increases to 1.78 in 2024. These systems have a benefit-cost ratio greater than one with and without incentives. The avoided bills component is the most significant contribution to the benefits and in this scenario the avoided bills component exceeds the system cost component for 2014-2024.



FIGURE 6-54: REPRESENTATIVE PCT RESULT FOR 400 KW PRT SYSTEM



The cost and benefit components are delineated below in Table 6-8. System cost represents the highest cost component whereas the avoided bills and federal tax represent the highest benefit components for the participant. Furthermore, for the participant, the avoided bills benefit increase with the increase in electricity costs and this explains the increasing high benefit/cost ratio.

TABLE 6-8: BREAKDOWN OF COSTS AND BENEFITS FOR 400 KW PRT SYSTEM PCT IN PG&E TERRITORY

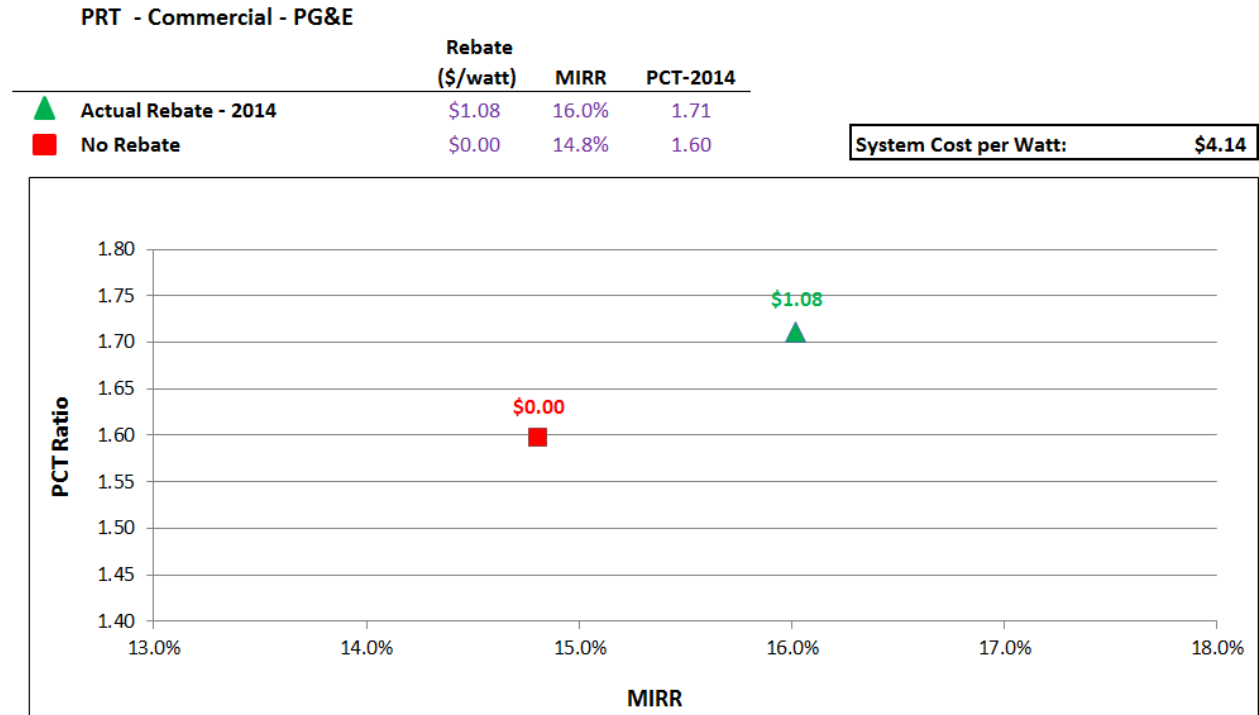
PCT	2014	2017	2020	2024
Costs				
System Cost	\$166,274	\$176,452	\$187,252	\$202,687
O&M Cost	\$41,334	\$41,931	\$42,563	\$43,468
Fueling Cost				
Standby Charges	\$21,763	\$24,244	\$27,152	\$31,609
Total Costs	\$229,372	\$242,626	\$256,967	\$277,764
Benefits				
Total Rebate	\$40,579	\$34,787	\$29,846	\$24,308
REC Revenue				
State Taxes	\$20,456	\$21,638	\$22,918	\$24,773
Federal Taxes	\$59,627	\$65,923	\$72,270	\$80,904
Avoided Bills	\$271,931	\$297,490	\$325,083	\$365,593
Total Benefits	\$392,593	\$419,838	\$450,117	\$495,577
Net Benefits	\$163,221	\$177,211	\$193,149	\$217,813
Ratio	1.71	1.73	1.75	1.78

Figure 6-55 shows the effect of different rebate levels on the participant’s rate of return and benefit-cost ratio for a nominal 400 kW PRT system installed in the PG&E territory. The benefit-cost ratio for all



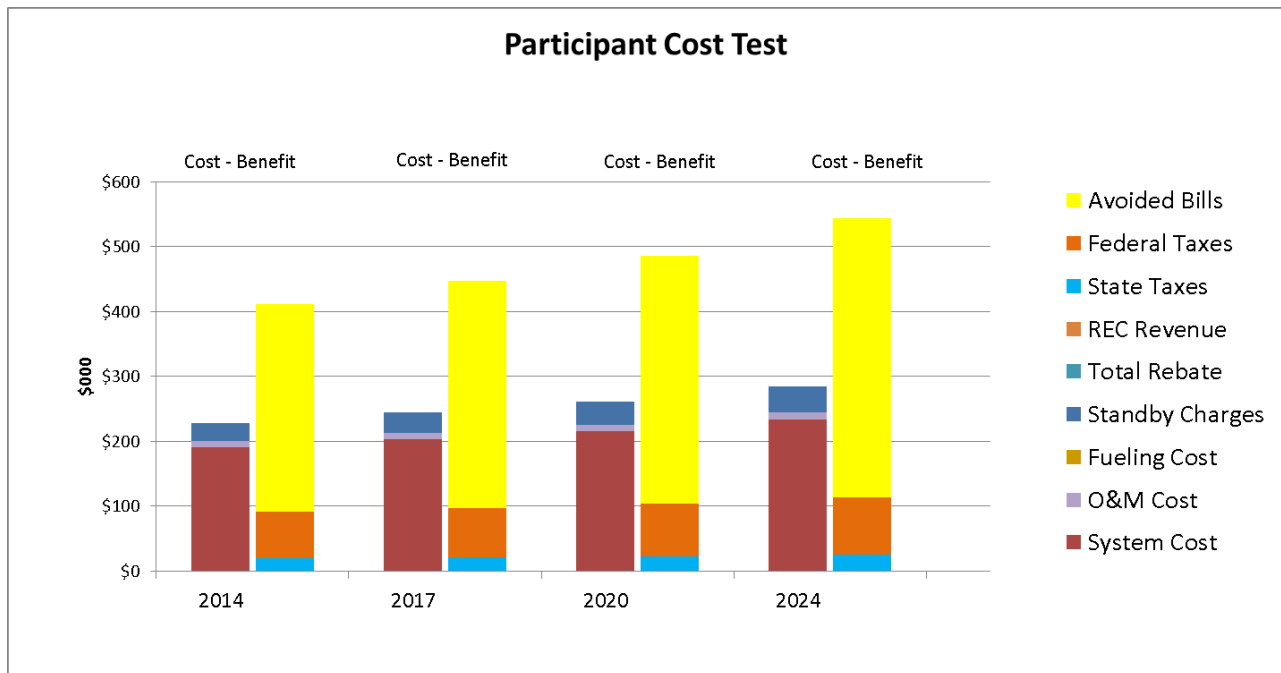
scenarios is greater than one. This means the systems benefit the participant with or without an incentive. The incentive only improves the rate of return for the participant but is not necessary to make the system cost effective.

FIGURE 6-55: PCT RESULTS FOR 400 KW PRT SYSTEM (PG&E)



WASTE HEAT TO POWER

The PCT result for a 500 kW ORC system (with no SGIP incentives) is shown in Figure 6-56. The benefit-cost ratio rises from 1.80 in 2014 to 1.91 in 2024. The avoided bills and federal taxes are the major benefit to the project. System costs are the most significant cost component and these increase slightly with time.

FIGURE 6-56: REPRESENTATIVE PCT RESULT FOR 500 KW ORC SYSTEM (NO SGIP INCENTIVE)


The cost and benefit components are delineated below in Table 6-9. For the participant, the avoided bills benefit increases with the increase in electricity costs and this explains the increasing benefit/cost ratio.

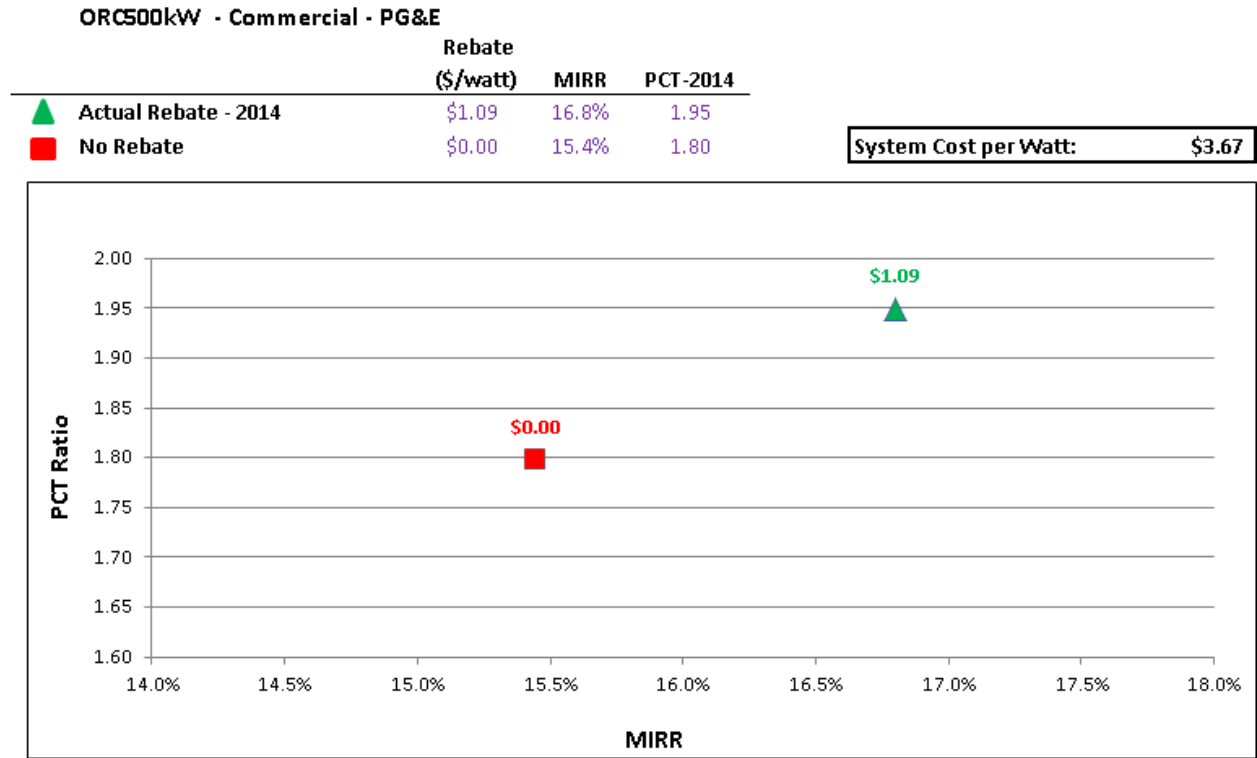
TABLE 6-9: BREAKDOWN OF COSTS AND BENEFITS FOR 500 KW ORC SYSTEM PCT IN PG&E TERRITORY

PCT	2014	2017	2020	2024
Costs				
System Cost	\$191,038	\$202,731	\$215,140	\$232,875
O&M Cost	\$9,440	\$10,017	\$10,630	\$11,507
Fueling Cost				
Standby Charges	\$28,025	\$31,197	\$34,936	\$40,671
Total Costs	\$228,503	\$243,946	\$260,707	\$285,052
Benefits				
Total Rebate				
REC Revenue				
State Taxes	\$19,743	\$21,081	\$22,533	\$24,643
Federal Taxes	\$71,260	\$76,086	\$81,327	\$88,942
Avoided Bills	\$320,073	\$350,230	\$382,745	\$430,446
Total Benefits	\$411,076	\$447,397	\$486,604	\$544,030
Net Benefits	\$182,573	\$203,451	\$225,897	\$258,977
Ratio	1.80	1.83	1.87	1.91



Figure 6-57 shows the effect of the current SGIP rebate on the participant’s rate of return and benefit-cost ratio for a nominal 500 kW ORC system assumed to be the PG&E territory. The incentive improves the participant’s rate of return and benefit-cost ratio but is not necessary to make the system cost effective in this scenario.

FIGURE 6-57: PCT RESULTS FOR 500 KW ORC SYSTEM



Natural Gas-Fueled Technologies

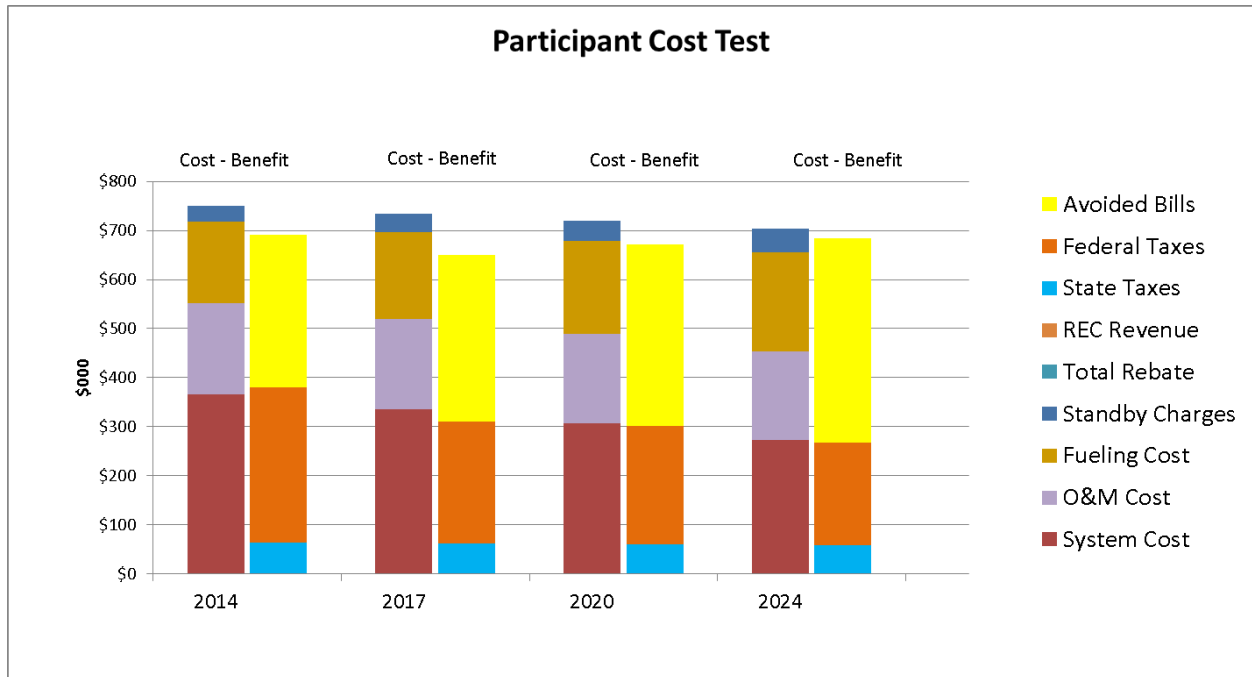
FUEL CELL TECHNOLOGIES

Commercial 500 kW CHP Natural Gas Fuel Cell Participant Cost Test

PCT results for a 500 kW CHP fuel cell supplied with natural gas without any incentives are depicted in Figure 6-58. For 2014, the participant benefit-cost ratio is 0.92. Bill savings and federal taxes represent the greatest benefits to the participant. On the cost side, system capital costs represent the greatest expenditure, followed by O&M costs and fueling costs. By 2024, the participant benefit-cost ratio is projected to increase to 0.97. Some of the reasons for this improvement are increasing electricity rates and decreasing system capital costs. These improvements outweigh the increasing fueling costs driven by natural gas rates and the phase-out of the Federal Incentive Tax Credit.



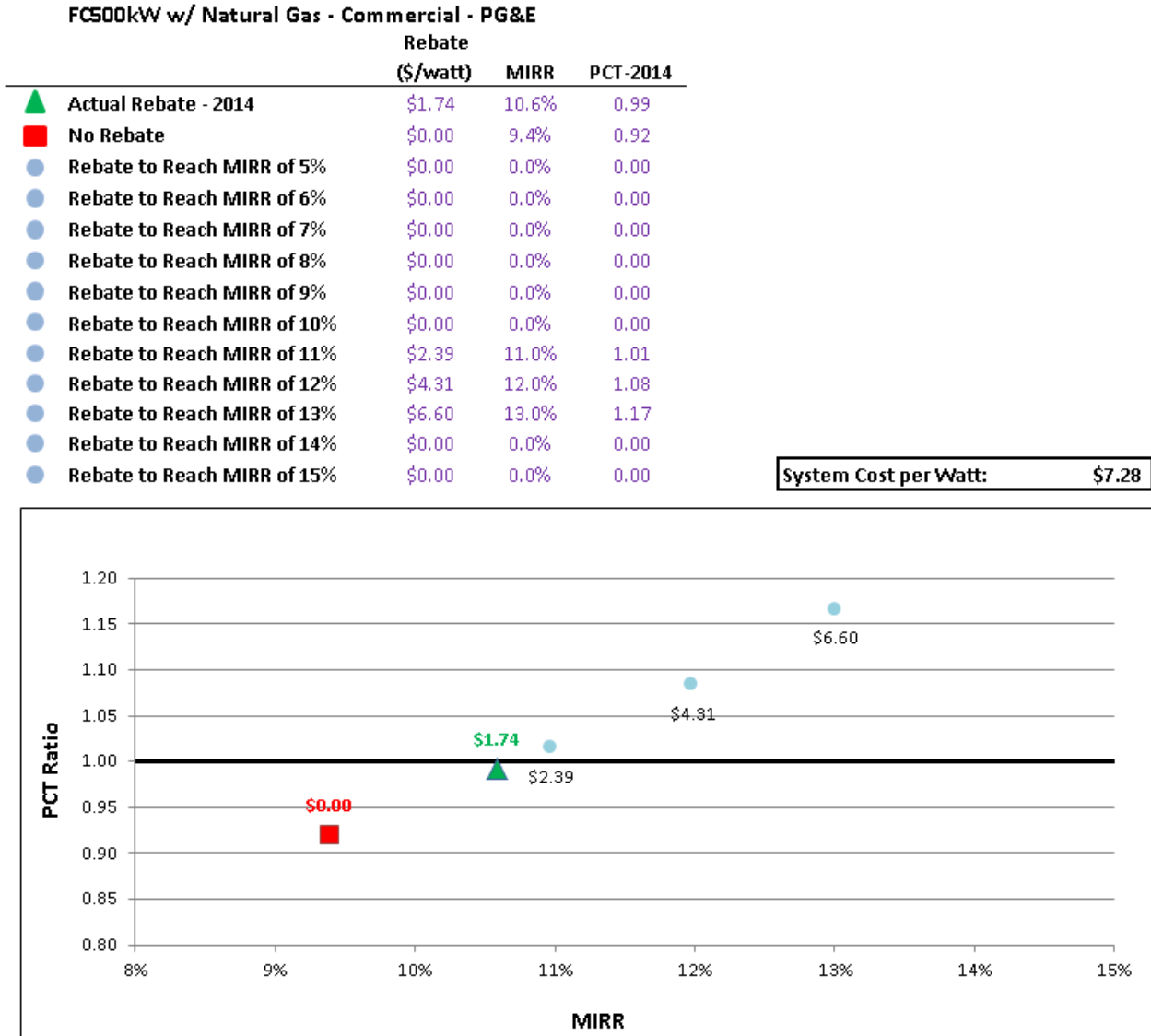
FIGURE 6-58: REPRESENTATIVE PARTICIPANT TEST RESULT FOR A NATURAL GAS 500 KW CHP FUEL CELL



The MIRR findings for a 500 kW natural gas CHP fuel cell are shown in Figure 6-59.



FIGURE 6-59: MIRR ANALYSIS FOR 500 KW NATURAL GAS CHP FUEL CELL



Without incentives, participants enjoy an MIRR of 9.4% which corresponds to a PCT ratio of 0.92. With the current SGIP incentive, the MIRR increases to 10.9% and the PCT ratio is 0.99. In order to reach an MIRR of 13% (the maximum before exceeding the system cost), the incentive amount would need to be increased by a factor of 3 to 4. This scenario would result in a PCT ratio of 1.17.

Commercial 500 kW Electric-Only Natural Gas Fuel Cell Participant Cost Test

Figure 6-60 shows PCT results for a 500 kW fuel cell operating in electric-only mode. The electric-only fuel cell does not obtain savings from avoided boiler fuel. Instead, it achieves increased electric bill savings from its greater electrical efficiency. Nonetheless, the relative proportions of the cost and benefits for the 500 kW all electric fuel cell are similar to the CHP fuel cell. In this case, the benefit-cost ratio for the participant increases from 0.93 in 2014 to 1.03 in 2024.



FIGURE 6-60: REPRESENTATIVE PARTICIPANT TEST RESULT FOR A NATURAL GAS 500 KW ELECTRIC-ONLY FUEL CELL

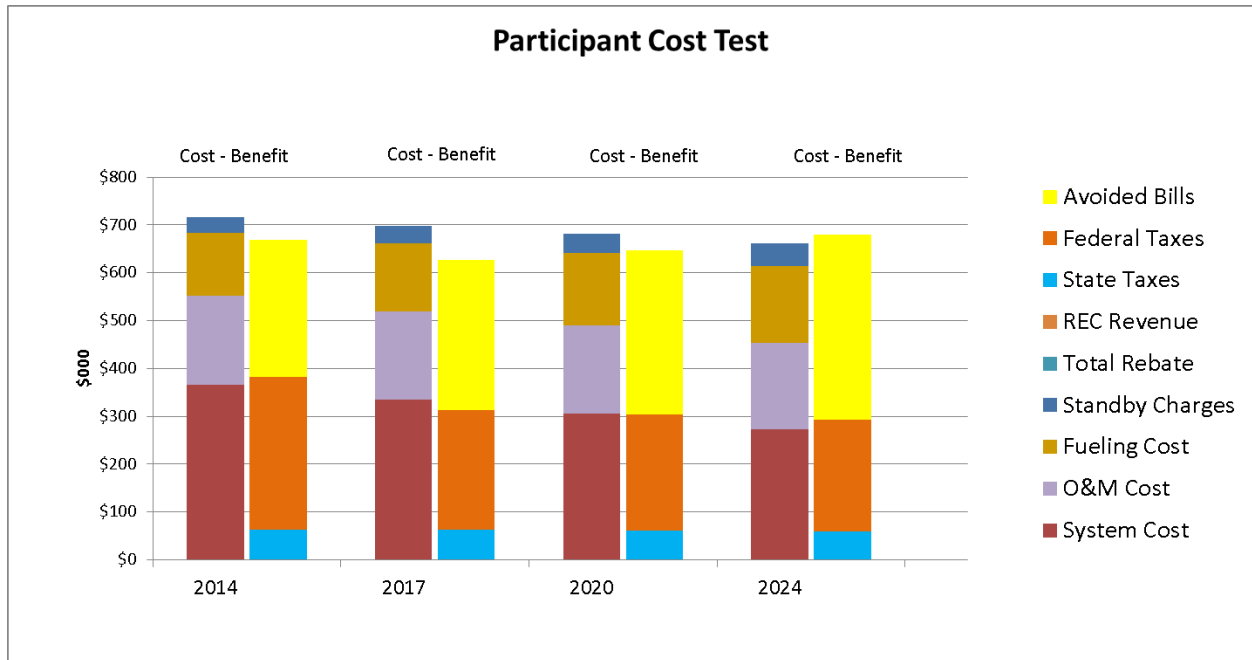
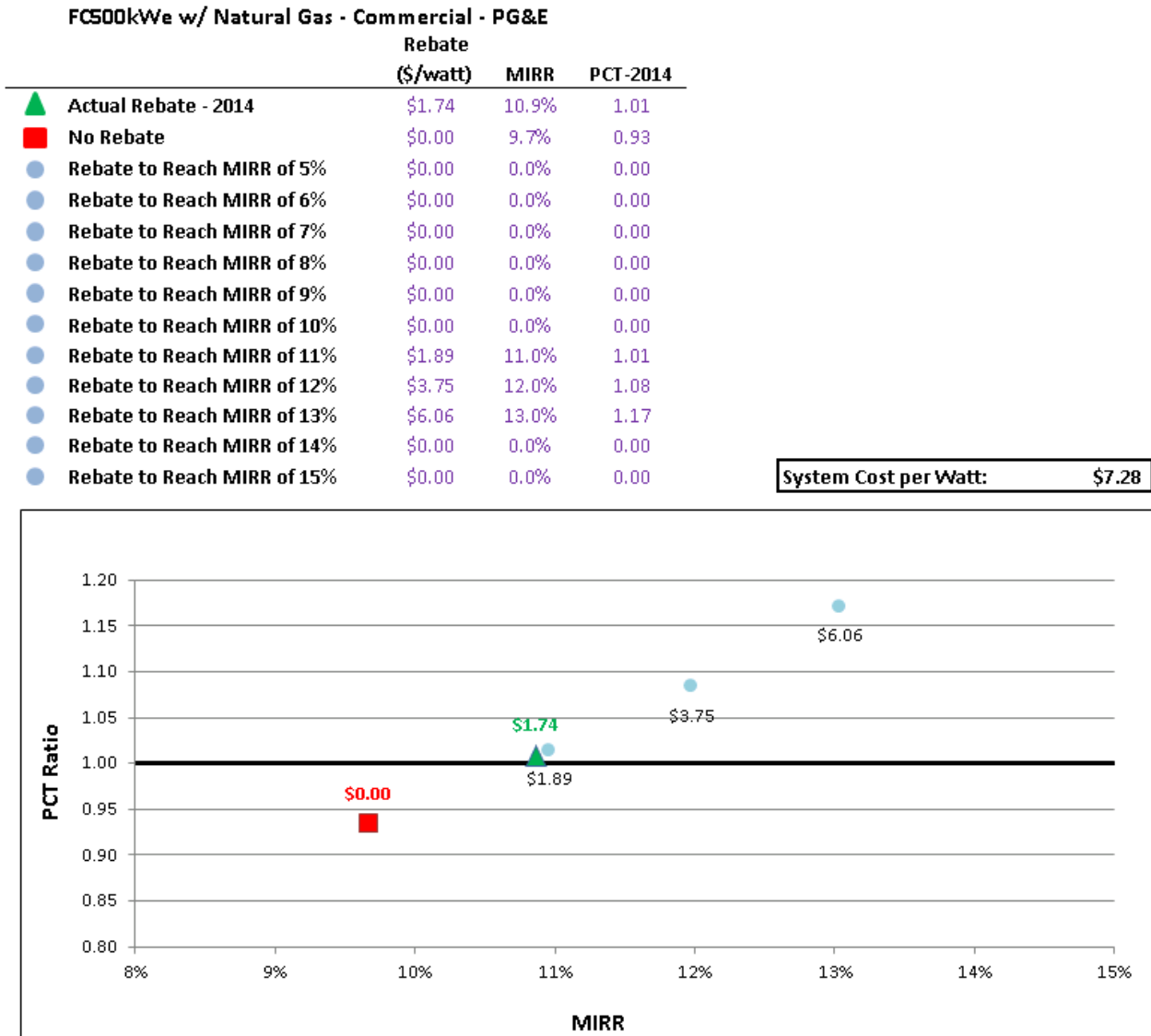


Figure 6-61 shows the MIRR results for a 500 kW natural gas electric-only fuel cell.



FIGURE 6-61: MIRR ANALYSIS FOR 500 KW NATURAL GAS ELECTRIC-ONLY FUEL CELL



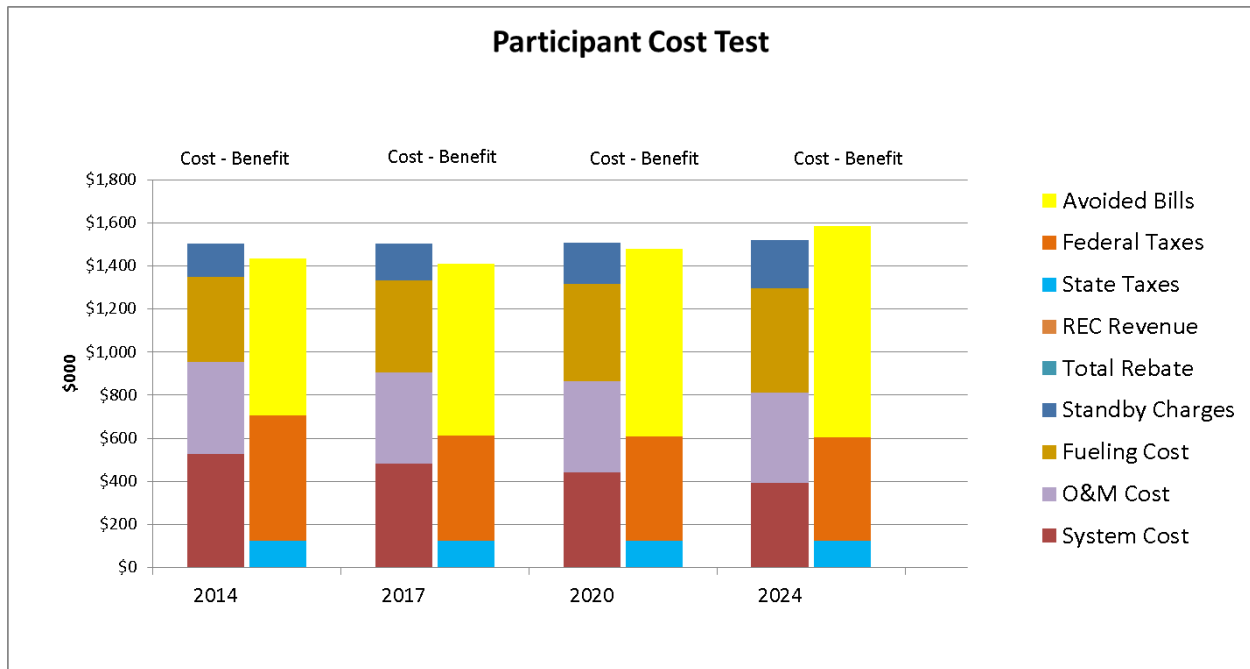
The MIRR results for the 500 kW electric-only fuel cell are similar to the 500 kW electric-only fuel cell PCT results. Without incentives, participants enjoy an MIRR of 9.7% which corresponds to a PCT ratio of 0.93. With the current SGIP incentive, the MIRR increases to 10.9% and the PCT ratio is 1.01. In order to reach an MRR of 13%, the incentive amount would need to be increased by a factor of 3 to 4. This scenario would result in a PCT ratio of 1.17.

Commercial 1200 kW CHP Natural Gas Fuel Cell Participant Cost Test

Figure 6-62 shows PCT results for a 1,200 kW CHP fuel cell. This case is similar to the 500 kW CHP fuel cell, but the project economics are more favorable on a per-Watt basis due to the effects of economies of scale. In this scenario, the participant test benefit-cost ratio increases from 0.95 in 2014 to 1.04 in 2024.



FIGURE 6-62: REPRESENTATIVE PARTICIPANT TEST RESULT FOR A NATURAL GAS 1,200 KW CHP FUEL CELL

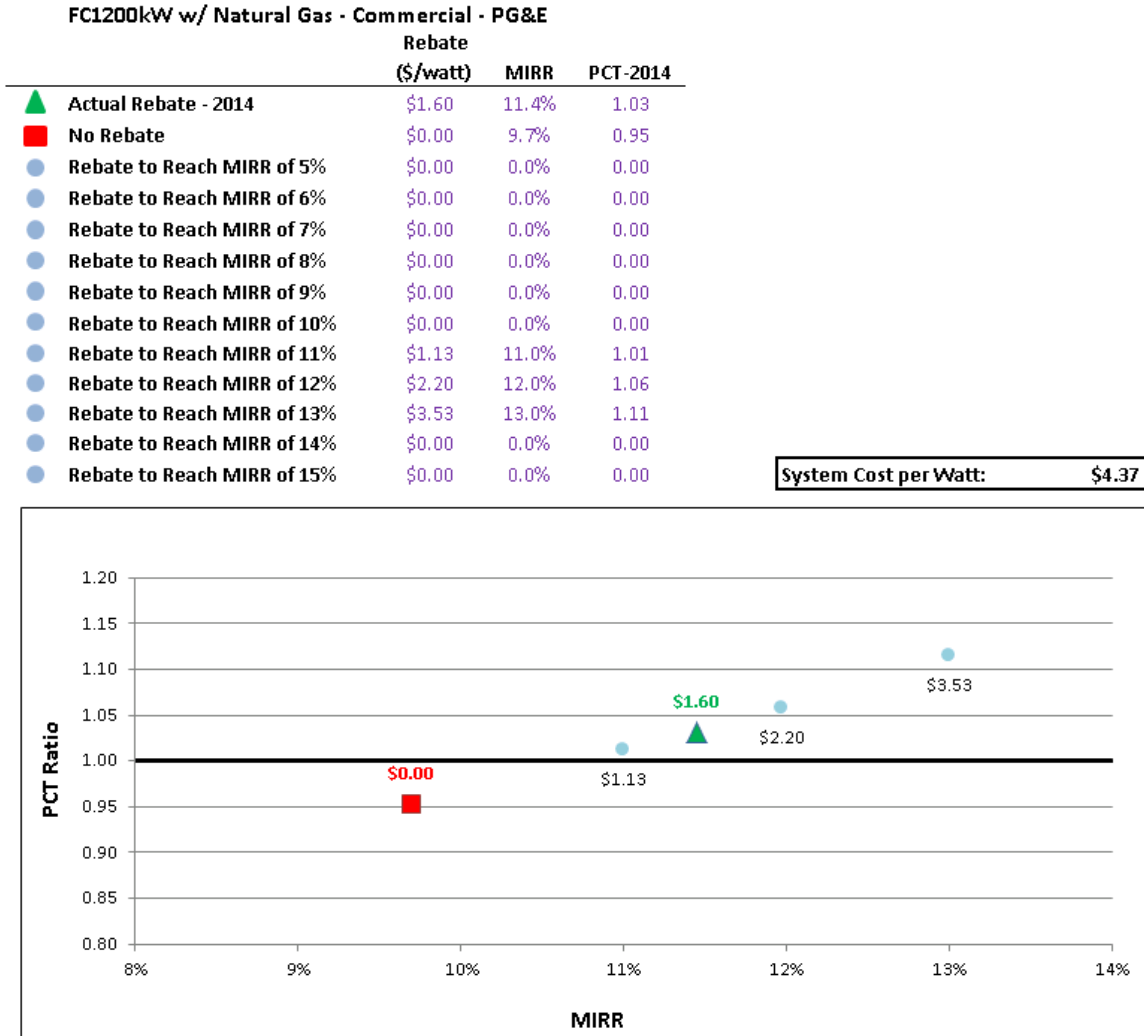


Based on the findings from the SGIPce model, natural gas fuel cells were not cost effective to participants without incentives in 2014. The cost effectiveness to participants is expected to improve based on the model assumptions. The model shows that 1,200 kW CHP fuel cells and 500 kW electric-only fuels supplied with natural gas will become cost effective without incentives by 2024.

Figure 6-63 shows the MIRR results for a 1,200 kW natural gas CHP fuel cell.



FIGURE 6-63: MIRR ANALYSIS FOR 1,200 KW NATURAL GAS CHP FUEL CELL



The 1,200 kW fuel cell is assumed to have a lower capital cost per Watt compared to the 500 kW fuel cells which results in more favorable project economics. Without incentives, participants enjoy an MIRR of 9.7% which corresponds to a PCT ratio of 0.95. With the current SGIP incentive, the MIRR increases to 11.4% and the PCT ratio is 1.03. In order to reach an MIRR of 13%, the incentive amount would need to be increased by a factor of 2 to 3. This scenario would result in a PCT ratio of 1.11.

For natural gas fuel cells, the SGIPce MIRR analysis shows that projects are not cost effective to participants without incentives but come close to being cost effective with the current SGIP incentive. If a more favorable participant benefit-cost ratio is desired, the incentive could be increased accordingly.

GAS TURBINE TECHNOLOGIES

Commercial 2.5 MW Natural Gas-Fueled Gas Turbine Participant Cost Test

Figure 6-64 shows the PCT results for a 2.5 MW gas turbine fueled by natural gas without incentives. High and increasing bill savings, coupled with federal tax benefits help make this project cost effective to



the participant. The benefit-cost ratio increases from 1.12 in 2014 to 1.20 by 2024. Note that this project is cost effective in light of relatively high fueling costs (e.g., approximately \$962,000 in 2014) and standby charges (e.g., approximately \$598,000 in 2014).

FIGURE 6-64: REPRESENTATIVE PARTICIPANT TEST RESULT FOR A NATURAL GAS 2.5 MW GAS TURBINE

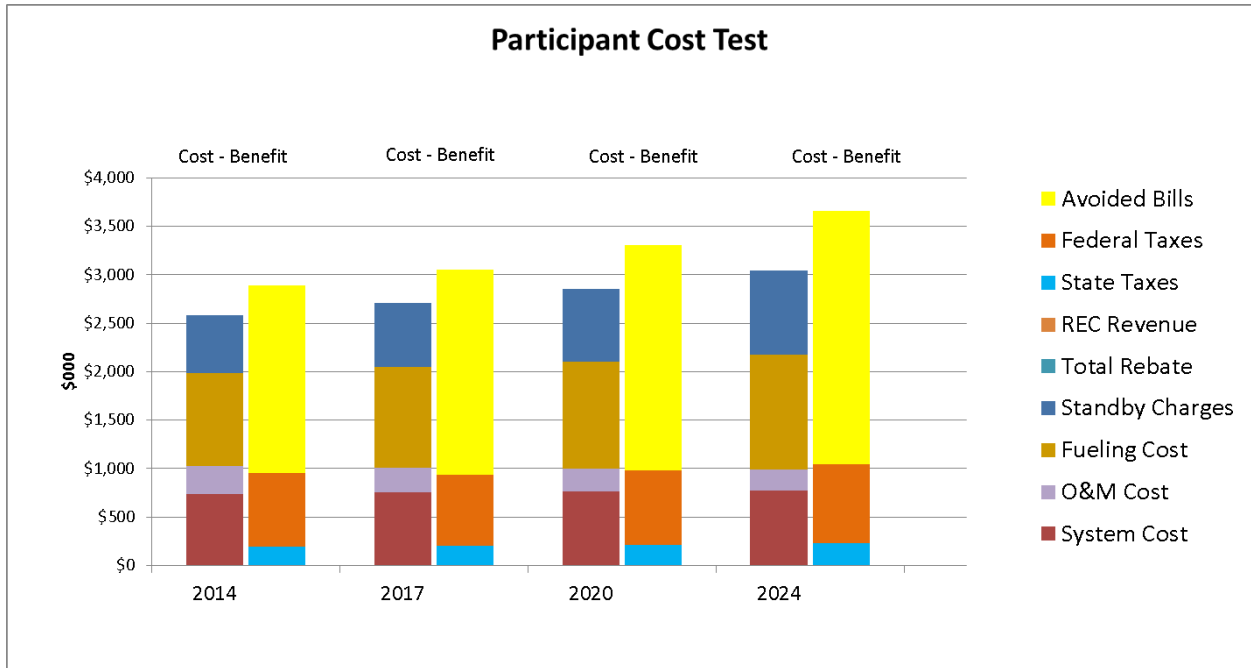
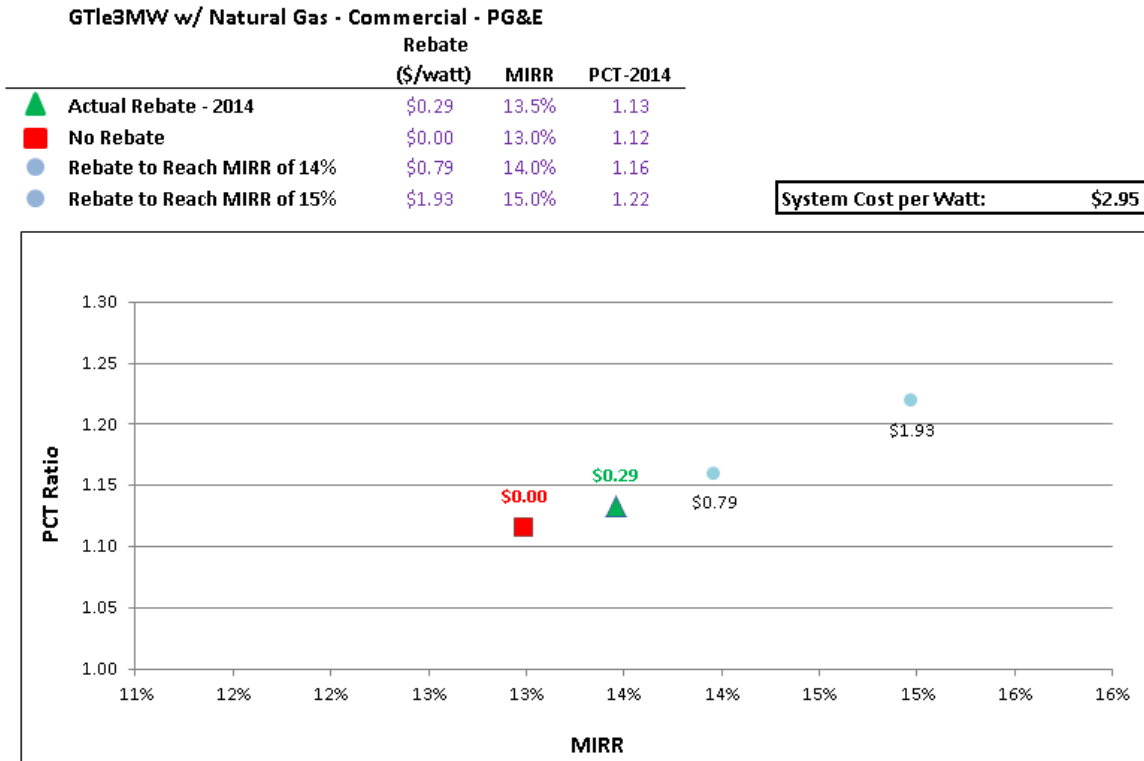


Figure 6-65 provides results of a MIRR analysis for the 2.5 MW gas turbine. This project has a 13% MIRR without any incentive. At 2014 incentive levels under the SGIP for this type of technology and fuel, the MIRR increases to 13.5%.

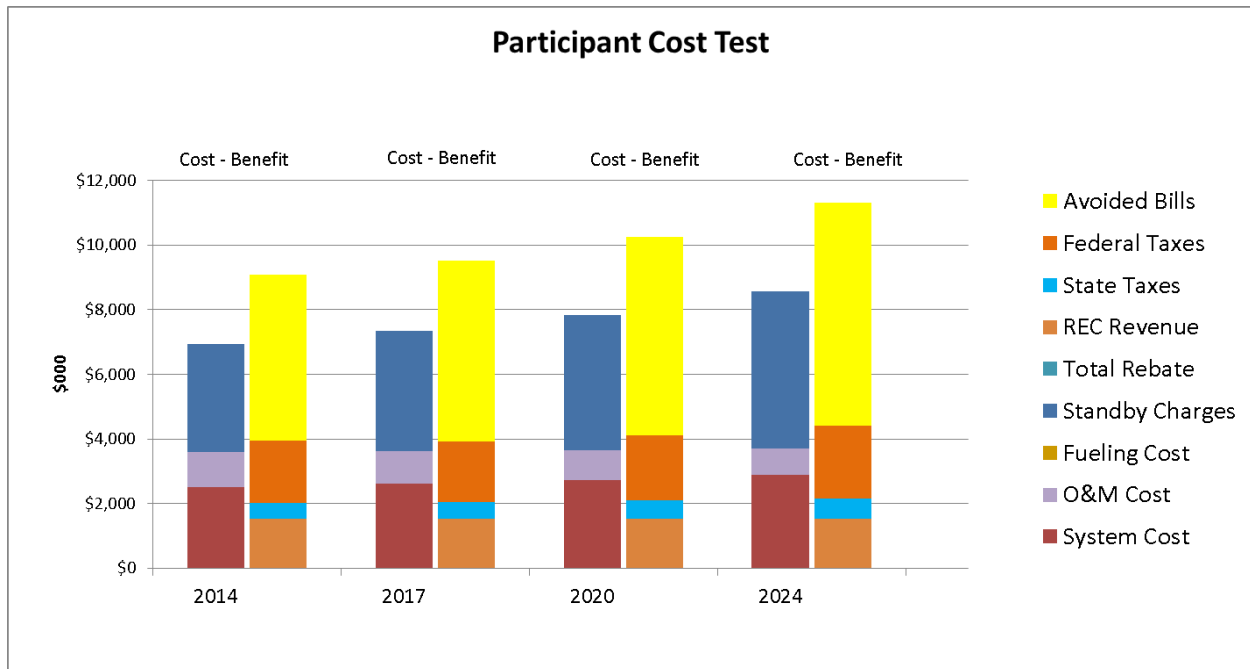


FIGURE 6-65: MIRR ANALYSIS FOR 2.5 MW NATURAL GAS-FUELED GAS TURBINE



Commercial 7 MW Natural Gas-Fueled Gas Turbine Participant Cost Test

Figure 6-66 shows the PCT breakout of costs and benefits for a 7 MW gas turbine fueled by natural gas without incentives. The PCT benefit-cost ratios for the larger gas turbine are lower than the smaller 2.5 MW gas turbine. At this size, standby charges become an increasingly large amount of the overall costs (approximately 38% of the overall costs for 2014), exceeding fueling costs (at approximately 31%). However, steadily rising bill savings push up the benefit-cost ratio from 0.97 in 2014 to 1.01 in 2024.

FIGURE 6-66: REPRESENTATIVE PARTICIPANT TEST RESULT FOR A NATURAL GAS 7 MW GAS TURBINE


Although not shown here, the MIRR results for the 7 MW gas turbine fueled by natural gas are very similar to those found for the smaller 2.5 MW gas turbine.

INTERNAL COMBUSTION ENGINE TECHNOLOGIES

Commercial 500 kW Natural Gas-Fueled IC Engine Participant Cost Test

Figure 6-67 shows the cost and benefits breakout of the PCT results for a 500 kW natural gas-fueled IC engine without incentives. Overall, the 500 kW IC engine fueled by natural gas appears to be an attractive project to participants. The benefit-cost ratio from 2014 to 2024 always exceeds 1; and in fact increases from 1.21 in 2014 to 1.37 by 2024. This occurs due to the combination of high bill savings and federal tax benefits joined by relatively low system costs.



FIGURE 6-67: REPRESENTATIVE PCT RESULT FOR A 500 KW NATURAL GAS FUELED IC ENGINE

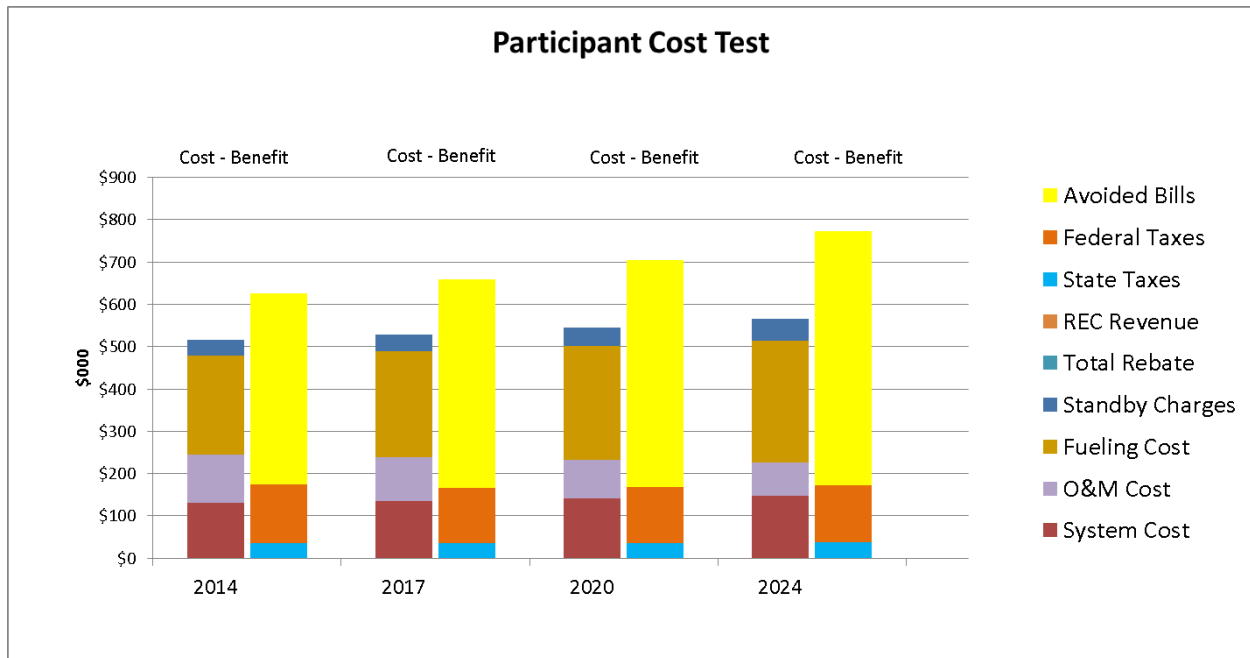
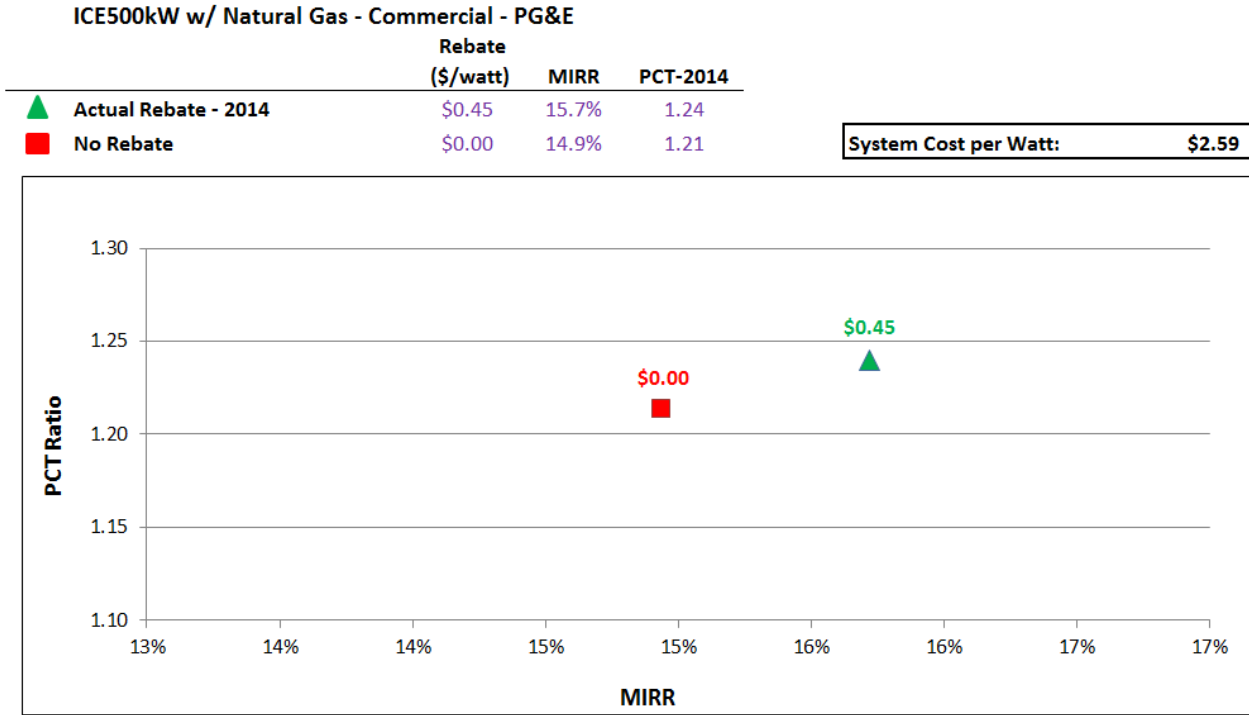


Figure 6-68 presents the MIRR analysis results for a 500 kW natural gas-fueled IC engine. Even without an incentive, the project has a MIRR of 14.9%, which reflects the attractive financial aspects of this technology. Assuming a 2014 PBI-incentive paid out under the SGIP of \$0.45/Watt, this project’s MIRR is increased to 15.7%.



FIGURE 6-68: MIRR ANALYSIS FOR 500 KW NATURAL GAS-FUELED IC ENGINE



Commercial 1500 kW Natural Gas-Fueled IC Engine Participant Cost Test

Figure 6-69 shows the cost and benefit PCT results for a 1500 kW natural gas-fueled IC engine. Like the 500 kW IC engine, the larger 1500 kW IC engine project also presents a very attractive financial situation. Similar to the reasons that drove up the benefit-cost ratio for the smaller IC engine, this project realizes ratios that increase from 1.18 in 2014 to 1.30 in 2024 without incentives.



FIGURE 6-69: REPRESENTATIVE PARTICIPANT TEST RESULT FOR A 1500 KW NATURAL GAS FUELED IC ENGINE

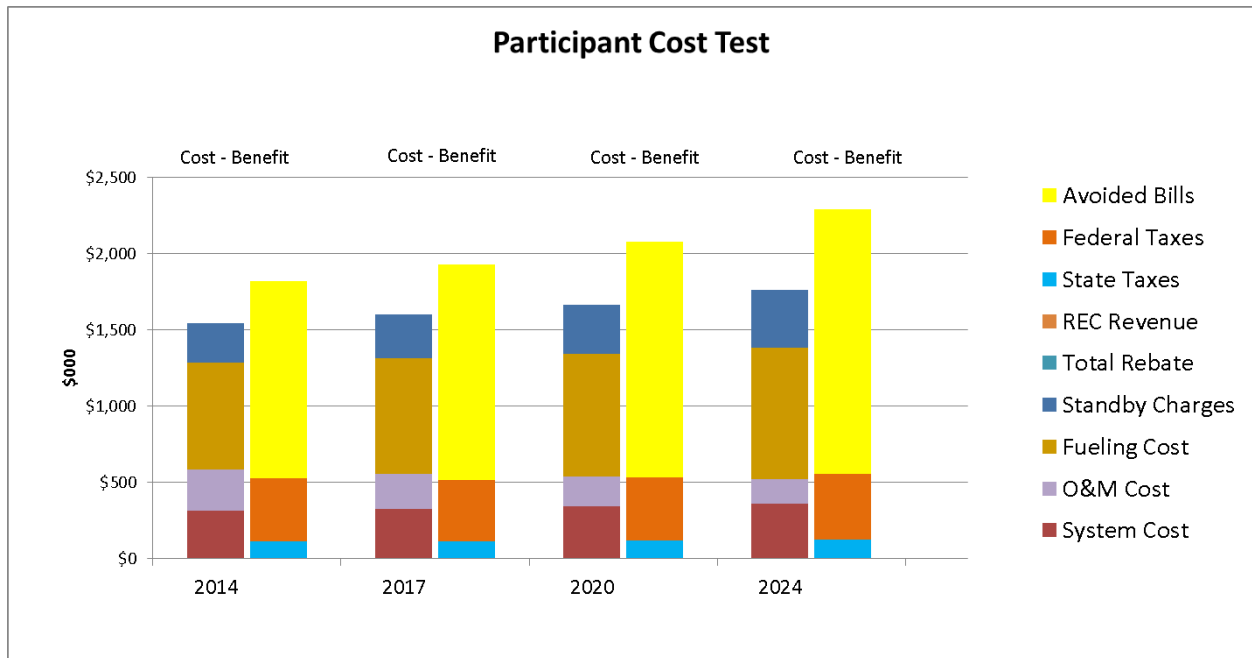
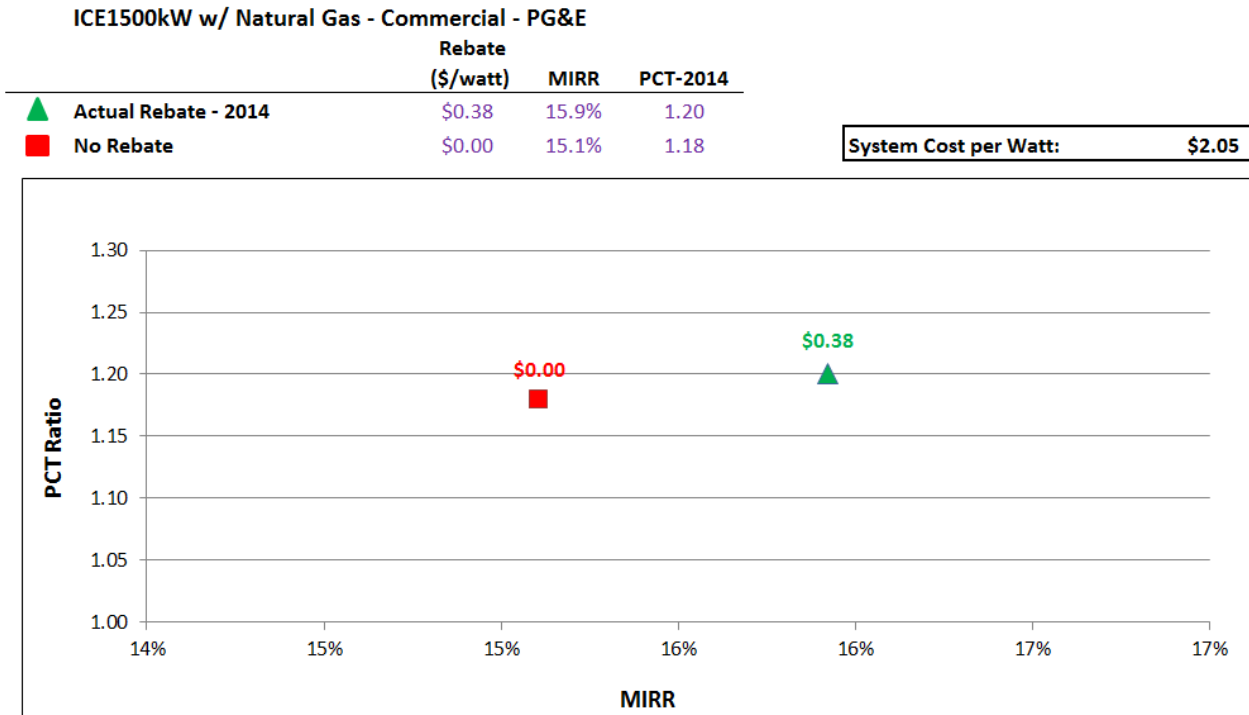


Figure 6-70 presents the MIRR analysis results for a 1500 kW natural gas-fueled IC engine. The MIRR for this project without any incentive is 15.1%. At the PBI incentive level expected at 2014 levels, the MIRR increases to 15.9%.



FIGURE 6-70: MIRR ANALYSIS FOR 1500 KW NATURAL GAS-FUELED IC ENGINE



MICROTURBINE TECHNOLOGIES

Commercial 200 kW Natural Gas-Fueled Microturbine Participant Cost Test

Figure 6-71 provides the cost and benefit components of the PCT for a 200 kW microturbine fueled by natural gas. While not as attractive of an investment as the natural gas-fired IC engines, the 200 kW natural gas fueled microturbine appears to be cost effective without any incentive. The benefit-cost ratio starts at 0.96 in 2014 and increases to 1.07 by 2024. The combination of high bill savings, favorable federal benefits and low system costs all help maintain the project’s cost effectiveness.



FIGURE 6-71: REPRESENTATIVE PCT RESULT FOR A 200 KW NATURAL GAS FUELED MICROTURBINE

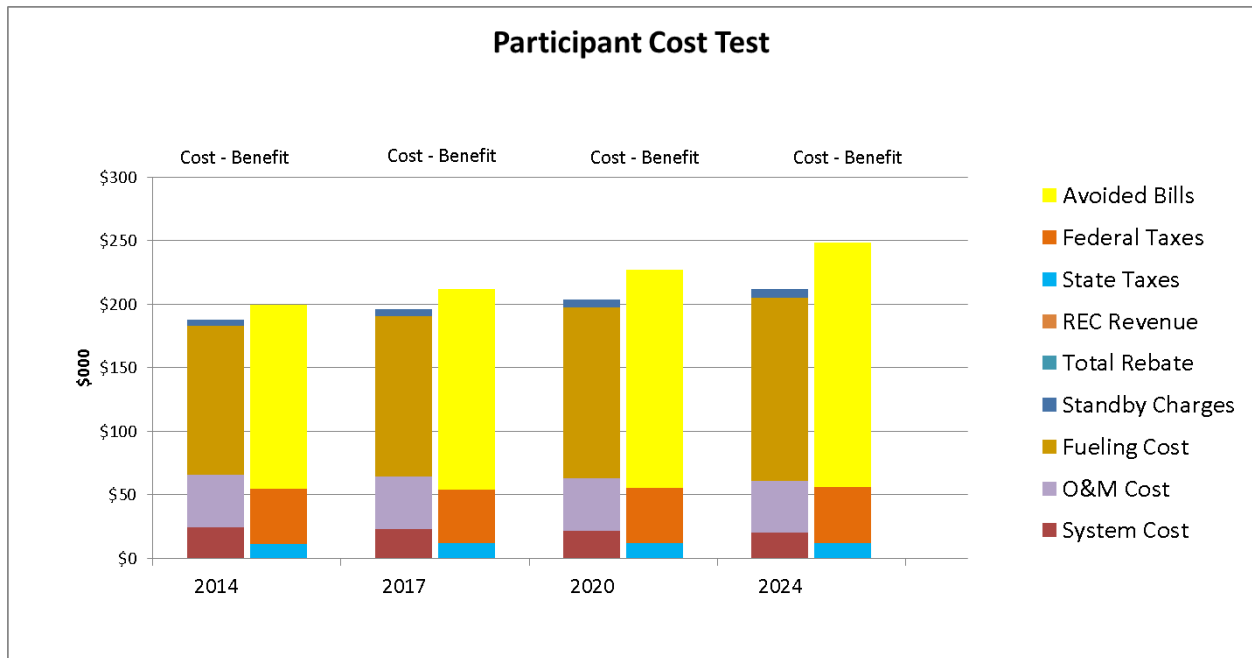
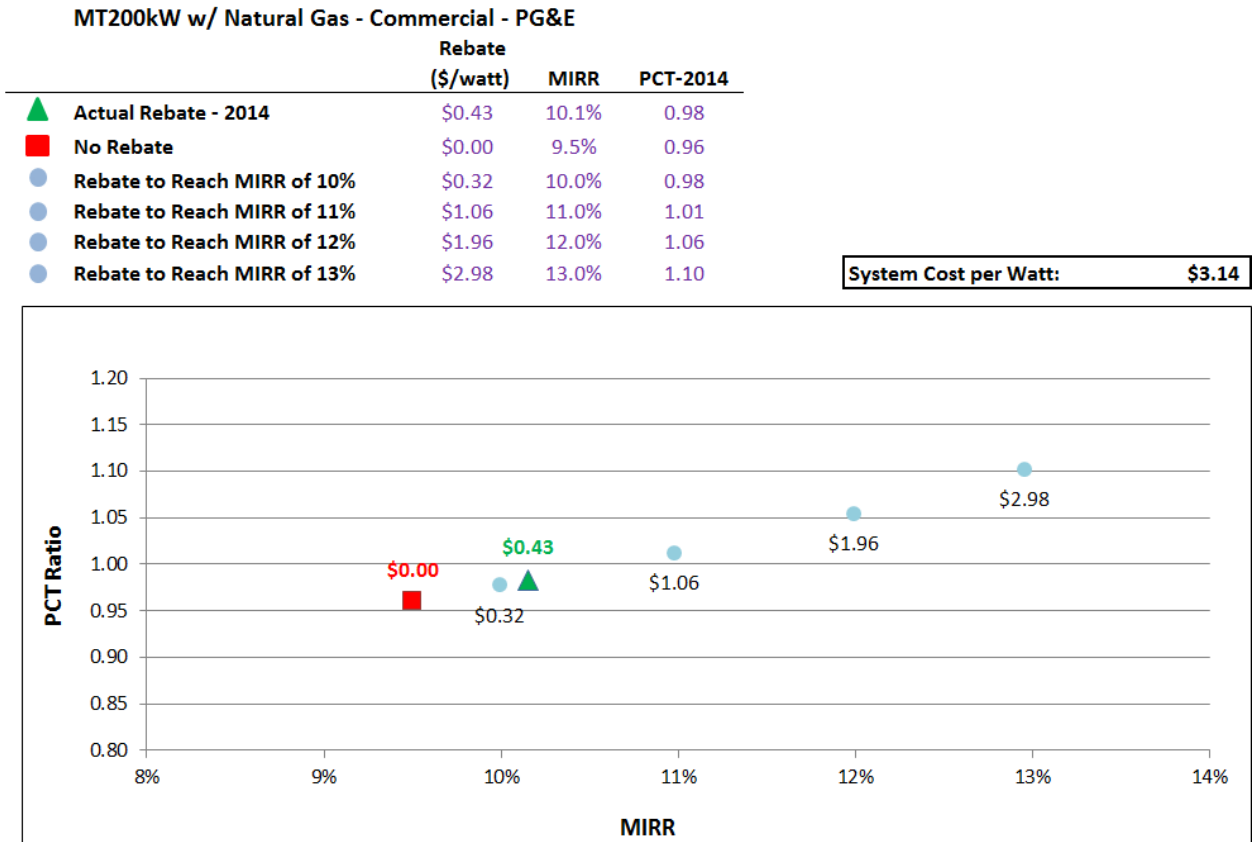


Figure 6-72 shows the results of the MIRR analysis for a 200 kW microturbine fueled by natural gas. Without incentives, the project has a MIRR of 9.5%. With the expected PBI incentive in 2014, the MIRR increases to 10.1%.



FIGURE 6-72: MIRR ANALYSIS FOR 200 KW NATURAL GAS-FUELED MICROTURBINE



Directed Biogas Gas-Fueled Technologies

FUEL CELL TECHNOLOGIES

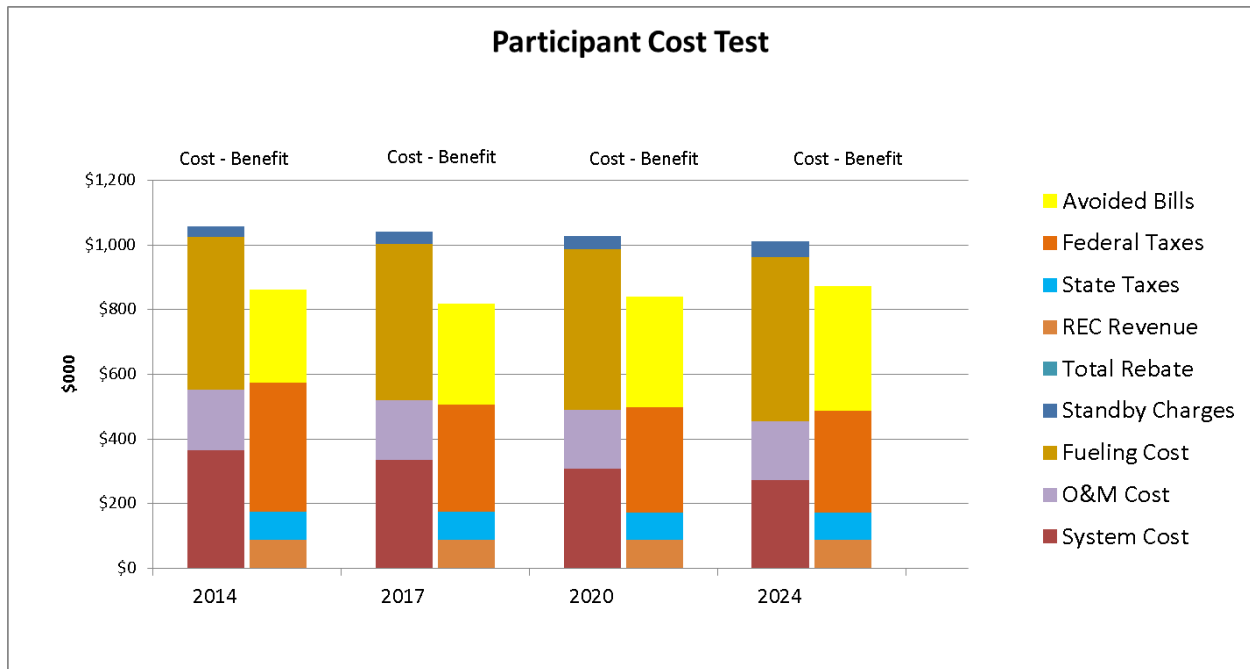
Directed biogas fuel cells face greater fueling costs due to the increased cost to procure and transport biogas in exchange for increased environmental benefits.

Commercial 500 kW CHP Directed Biogas Fuel Cell Participant Cost Test

Figure 6-73 shows PCT results for a 500 kW CHP fuel cell that consumes directed biogas. Fueling charges dominate the cost to participants during all years, followed by system capital and O&M costs. Avoided bills and federal tax treatment are the largest benefits. The cost-benefit ratio to participants is 0.81 during 2014, increasing to 0.86 by 2024.



FIGURE 6-73: REPRESENTATIVE PARTICIPANT TEST RESULT FOR A DIRECTED BIOGAS 500 KW CHP FUEL CELL

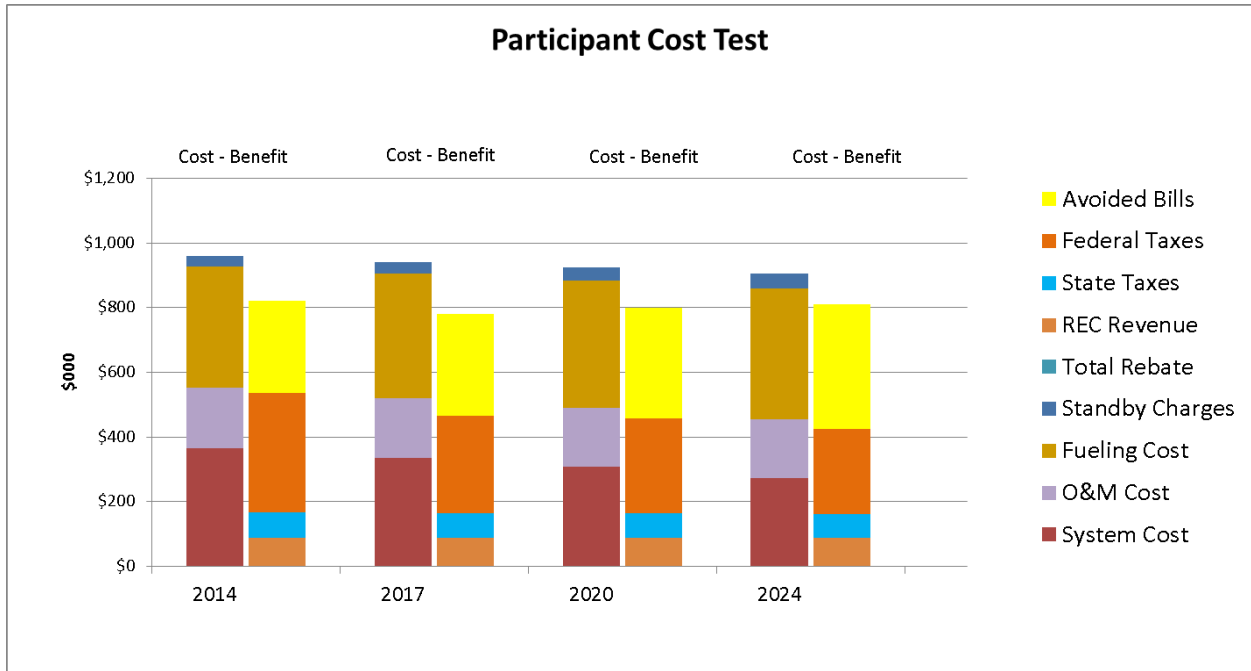


Commercial 500 kW Electric-Only Directed Biogas Fuel Cell Participant Cost Test

Figure 6-74 shows the PCT results for a 500 kW directed biogas electric-only fuel cell. The results are similar to the 500 kW case but in this scenario avoided bill savings are greater due to the higher electrical efficiency of electric-only fuel cells. The participant benefit-cost ratio increases from 0.86 in 2014 to 0.89 by 2024.



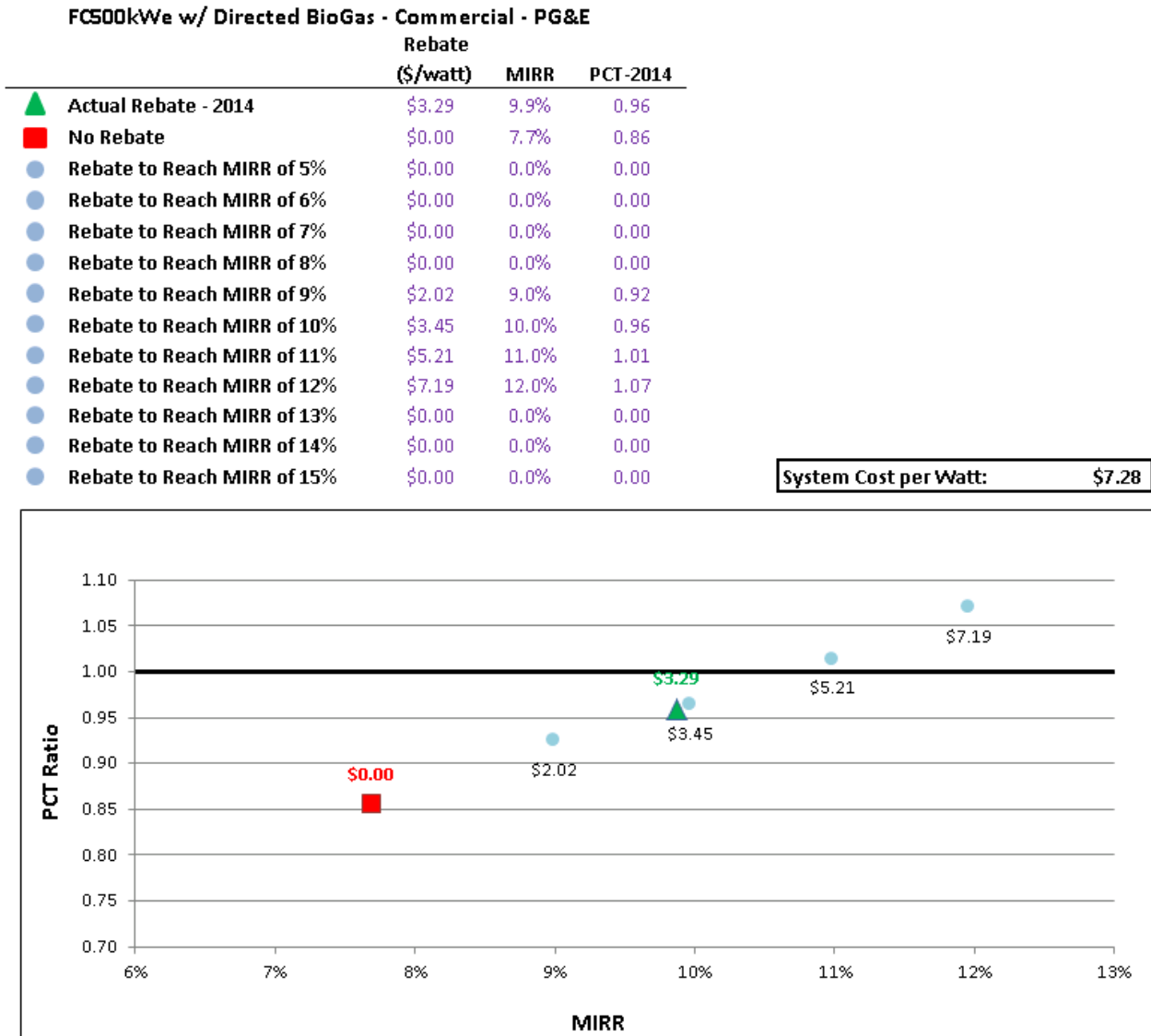
FIGURE 6-74: REPRESENTATIVE PARTICIPANT TEST RESULT FOR A DIRECTED BIOGAS 500 KWW ELECTRIC-ONLY FUEL CELL



The MIRR findings for a 500 kW directed biogas electric-only fuel cell are shown in Figure 6-75.



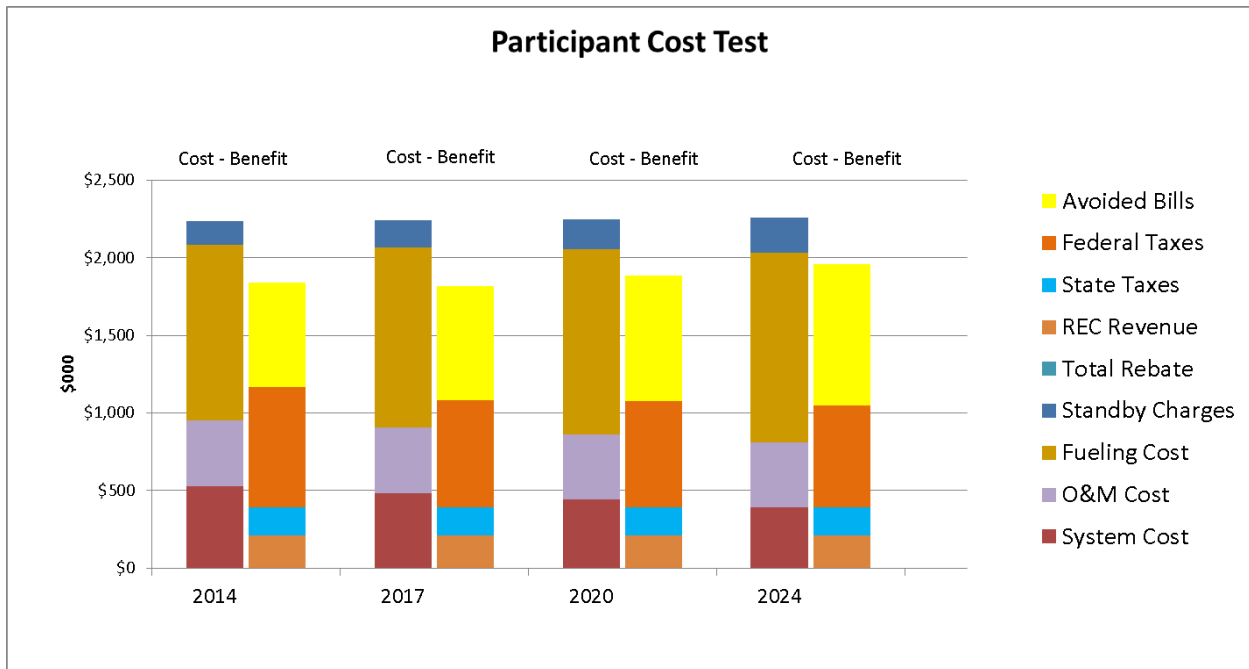
FIGURE 6-75: MIRR ANALYSIS FOR 500 KW DIRECTED BIOGAS ELECTRIC-ONLY FUEL CELL



Without incentives, participants enjoy an MIRR of 7.7% which corresponds to a PCT ratio of 0.86. With the 2014 SGIP incentive, the MIRR increases to 9.9% and the PCT ratio is 0.96. In order to reach an MIRR of 12%, the incentive amount would need to be increased by a factor of 2 to 3. This scenario would result in a PCT ratio of 1.07.

Commercial 1,200 kW CHP Directed Biogas Fuel Cell Participant Cost Test

Figure 6-76 shows the participant test results for a 1,200 kW directed biogas CHP fuel cell. In this scenario, the economies of scale that benefit the cost effectiveness of the onsite biogas fuel cell are not applicable since the increased costs of directed biogas are entirely a function of therms consumed (i.e. variable as opposed to fixed). The participant benefit-cost ratio is 0.82 for 2014 and increases to 0.87 by 2024.

FIGURE 6-76: REPRESENTATIVE PARTICIPANT TEST RESULT FOR A DIRECTED BIOGAS 1,200 KW CHP FUEL CELL


The model shows that directed biogas fuel cells are never cost effective to participants without incentives. While the benefit-cost ratios increase with falling system costs, the systems are not cost effective by 2024.

GAS TURBINE TECHNOLOGIES

Commercial 2.5 MW Directed Biogas-Fueled Gas Turbine Participant Cost Test

Figure 6-77 shows the PCT results for a 2.5 MW gas turbine fueled by directed biogas without incentives. The impacts of the higher fueling costs (due to the higher priced directed biogas) become apparent in the lower benefit-cost ratios. In 2014, fueling costs represent over 60% of the total cost of the project, whereas system capital costs represent only 17%. The result is a benefit-cost ratio of 0.88 in 2014. However, steadily rising bill savings, driven by increasing electricity prices help to increase overall benefits and by 2024, the benefit-cost ratio rises to 0.96.



FIGURE 6-77: REPRESENTATIVE PARTICIPANT TEST RESULT FOR A DIRECTED BIOGAS 2.5 MW GAS TURBINE

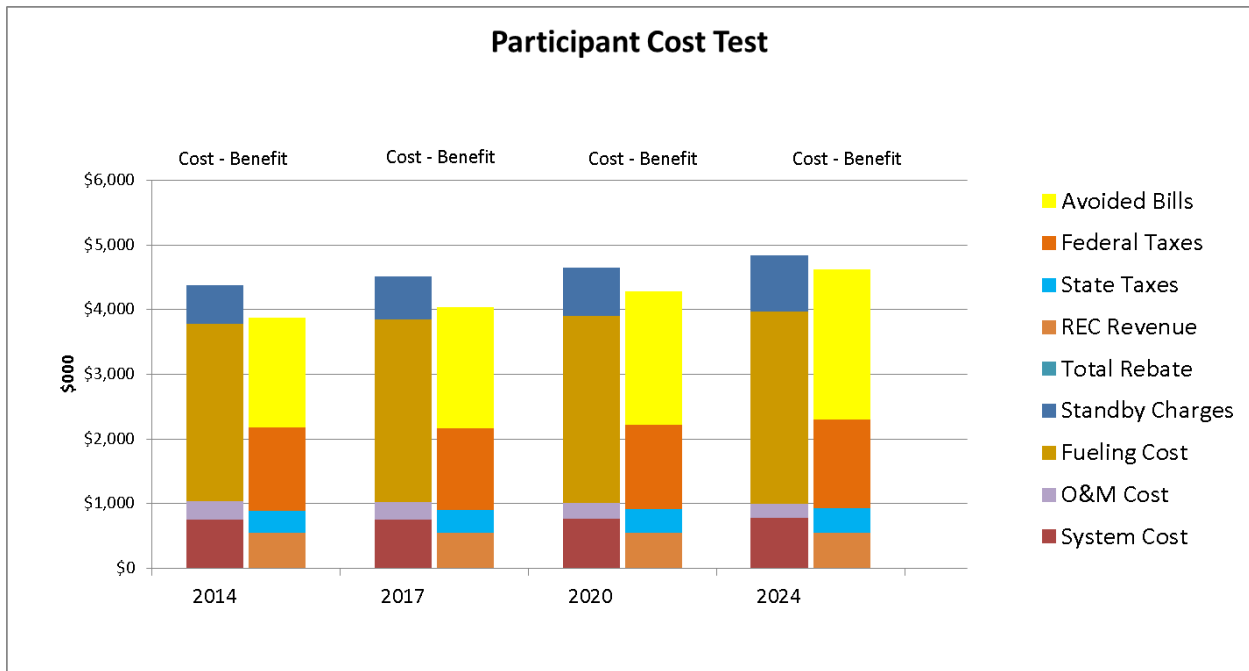
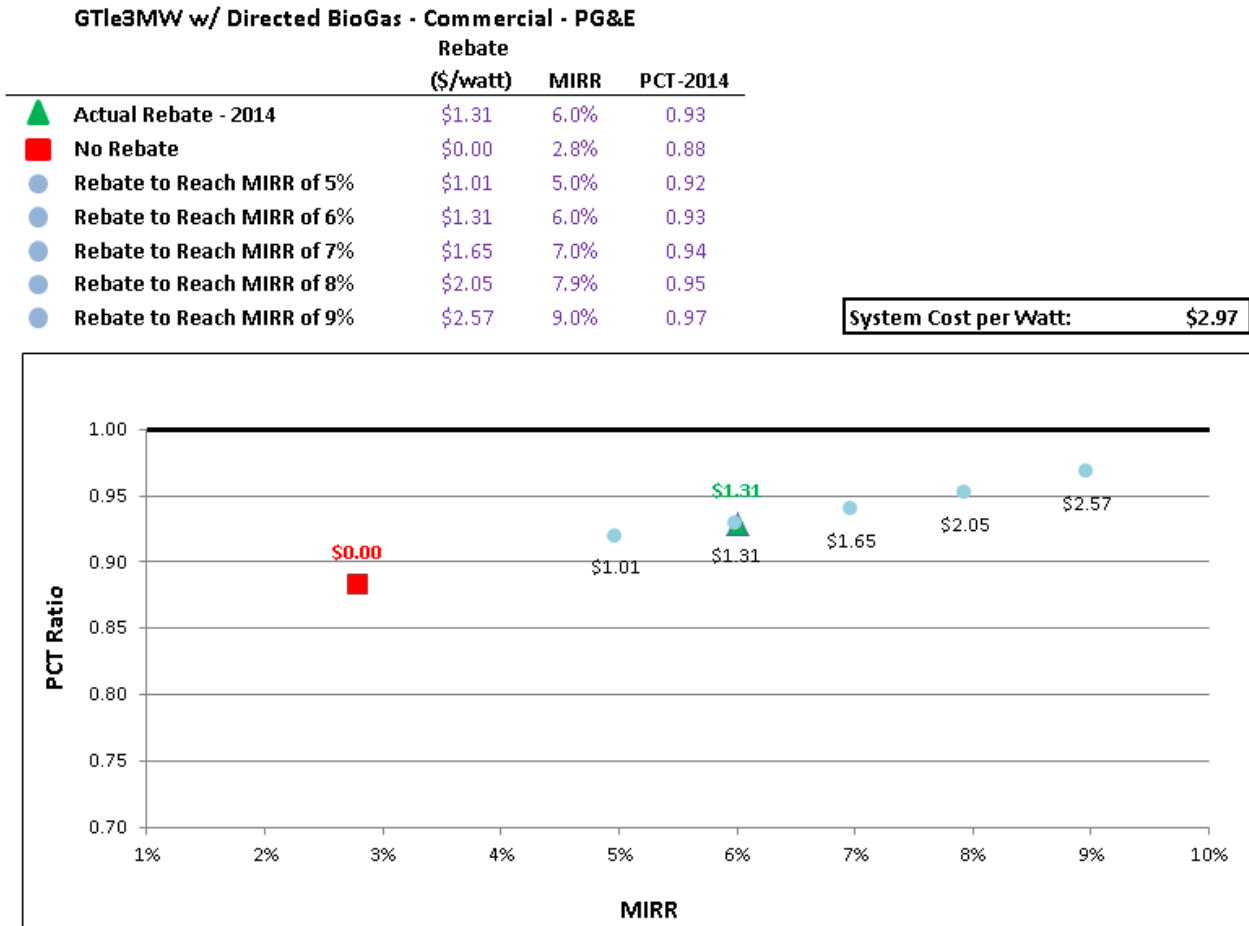


Figure 6-78 shows the PCT results for a 2.5 MW gas turbine fueled by directed biogas. Without incentives, the project has a MIRR of 2.8%. With an expected 2014 PBI incentive of \$1.31 per Watt, the MIRR increases to 6%. To reach a MIRR of 9%, the project would require an incentive level of \$2.57 per Watt. Incentives to reach a MIRR of 10% or higher would exceed the cost of the system.



FIGURE 6-78: MIRR ANALYSIS FOR 2.5 MW DIRECTED BIOGAS-FUELED GAS TURBINE



Commercial 7 MW Directed Biogas-Fueled Gas Turbine Participant Cost Test

Figure 6-79 presents the cost and benefit components of the PCT test on a 7 MW gas turbine fueled by directed biogas. Again, as with the smaller 2.5 MW gas turbine, the higher price of directed biogas has impacts on the cost effectiveness of the project. However, in addition to rising fuel costs, standby charges emerge as a significant fraction of the project costs; accounting for approximately 24% of the overall project costs in 2014. Benefit-cost ratios do climb with increasing bill savings but only increase from 0.82 in 2014 to 0.86 by 2024.



FIGURE 6-79: REPRESENTATIVE PARTICIPANT TEST RESULT FOR A DIRECTED BIOGAS 7 MW GAS TURBINE

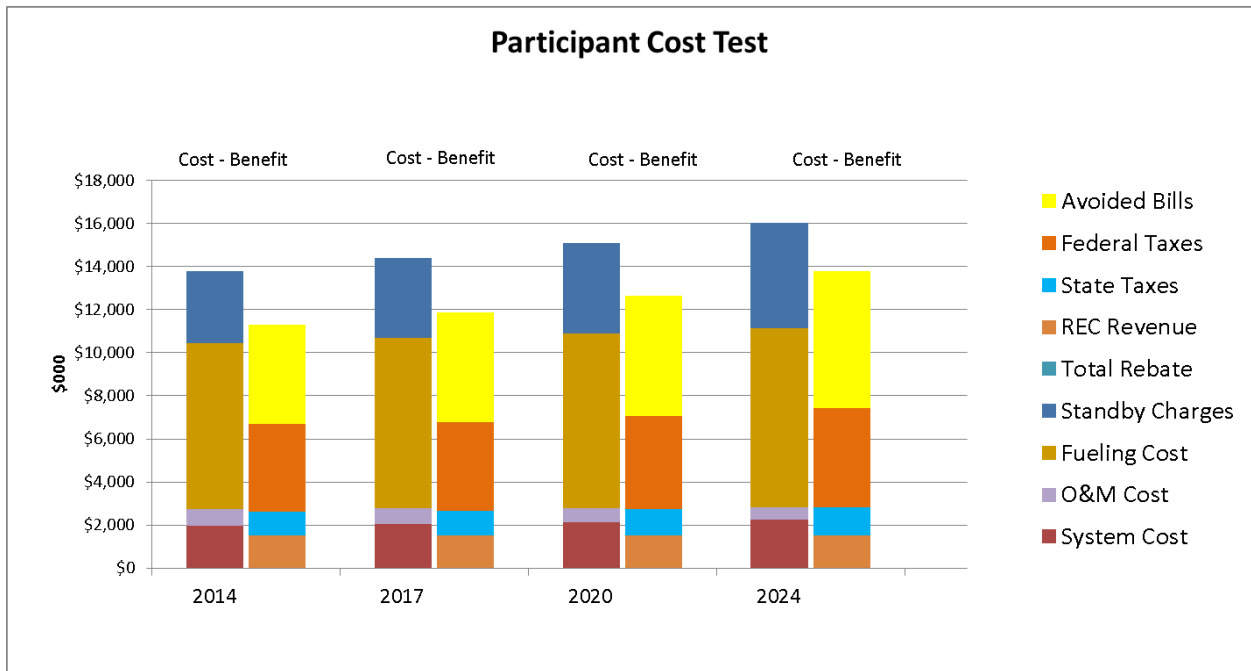
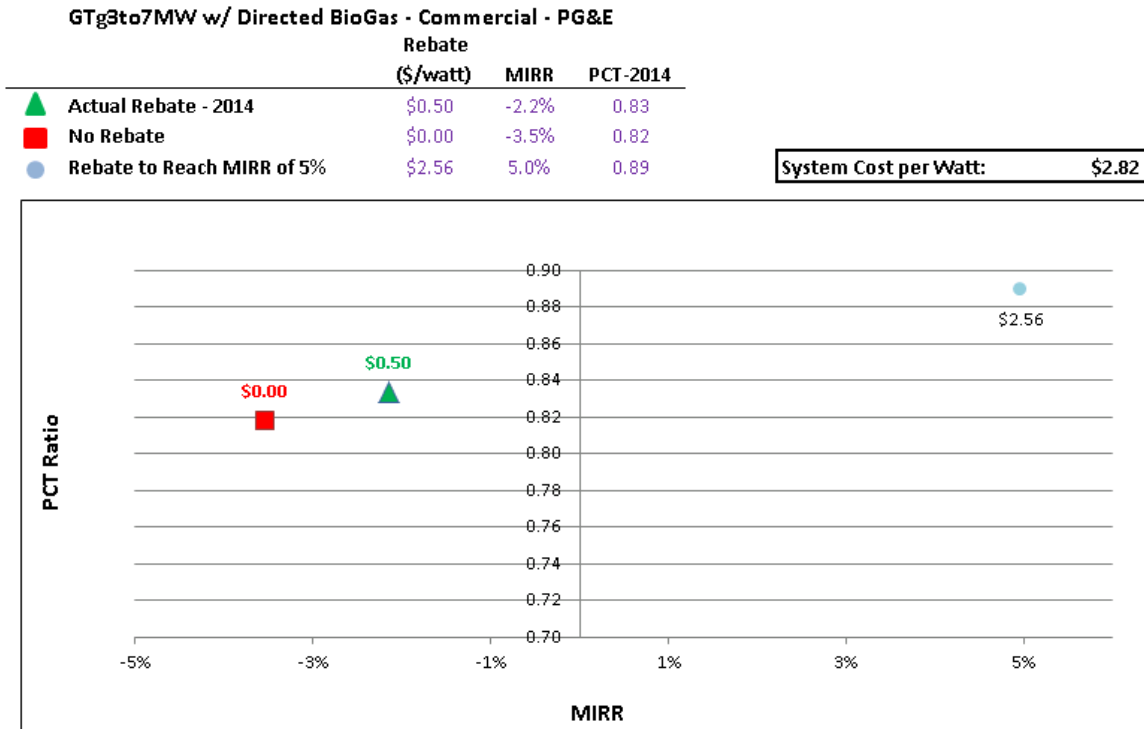


Figure 6-80 shows the MIRR analysis results for the 7 MW gas turbine fueled by directed biogas. Even with an expected 2014 PBI incentive of \$0.50 per Watt, the project fails to achieve a positive MIRR. A PBI incentive equal to \$2.56 per Watt would be necessary to help achieve a MIRR of 5%. An incentive to reach a MIRR of 6% or higher would exceed the cost of the system.



FIGURE 6-80: MIRR ANALYSIS FOR 7 MW DIRECTED BIOGAS-FUELED GAS TURBINE



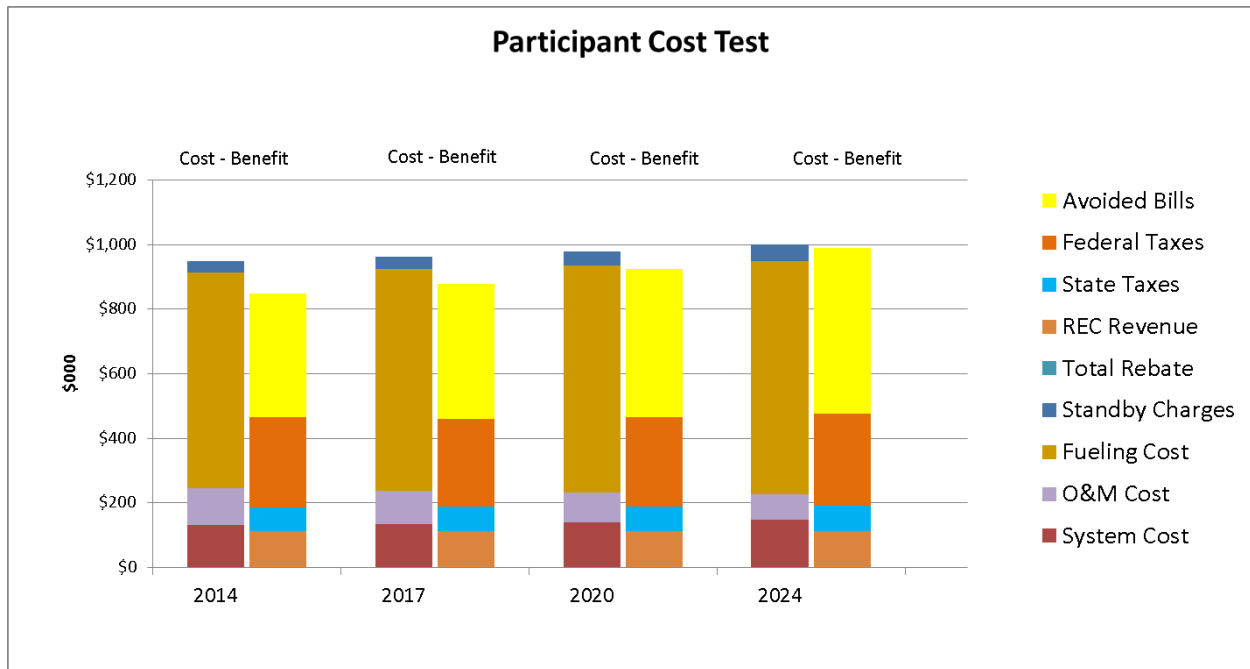
INTERNAL COMBUSTION ENGINE TECHNOLOGIES

Commercial 500 kW Directed Biogas-Fueled IC Engine Participant Cost Test

Figure 6-81 shows PCT results for a representative 500 kW IC engine fueled by directed biogas without incentives. High fueling costs also impact the 500 kW IC engine. However, on a percentage basis, benefits accrue not just from avoided bills but also from REC revenue and favorable federal tax treatment. As a result, the benefit-cost ratio increases from 0.89 in 2014 to 0.99 by 2024.



FIGURE 6-81: REPRESENTATIVE PCT RESULT FOR A DIRECTED BIOGAS 500 KW IC ENGINE



Commercial 1500 kW Directed Biogas-Fueled IC Engine Participant Cost Test

Figure 6-82 shows the PCT results for a 1500 kW IC engine fueled by directed biogas. As with the smaller IC engine, fueling costs from the higher priced directed biogas tend to drive down the cost effectiveness of the project. For example, fueling costs in 2014 represented over 70% of the total project costs. However, increasing bill savings, favorable federal tax treatment (which accounted for over 33% of all the project benefits in 2014) and emerging REC revenue act to push up the benefit-cost ratio over time. The benefit-cost ratio increases from 0.87 in 2014 to 0.96 by 2024 even without SGIP incentives.



FIGURE 6-82: REPRESENTATIVE PARTICIPANT TEST RESULT FOR A DIRECTED BIOGAS 1500 KW IC ENGINE

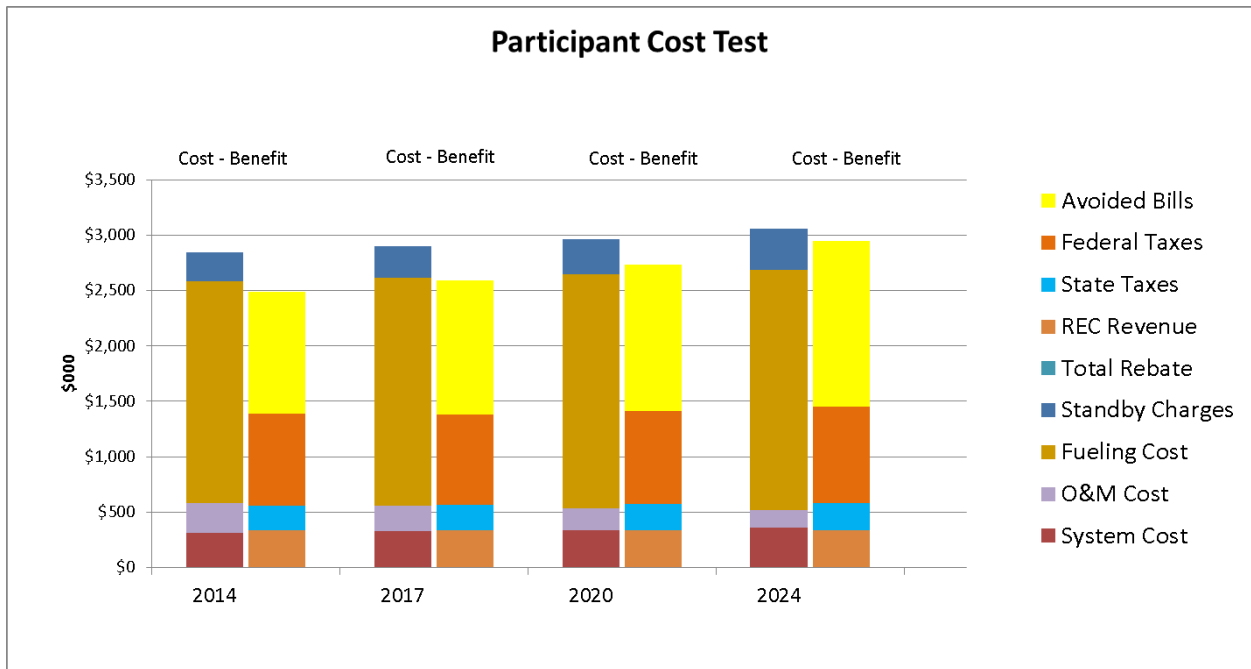
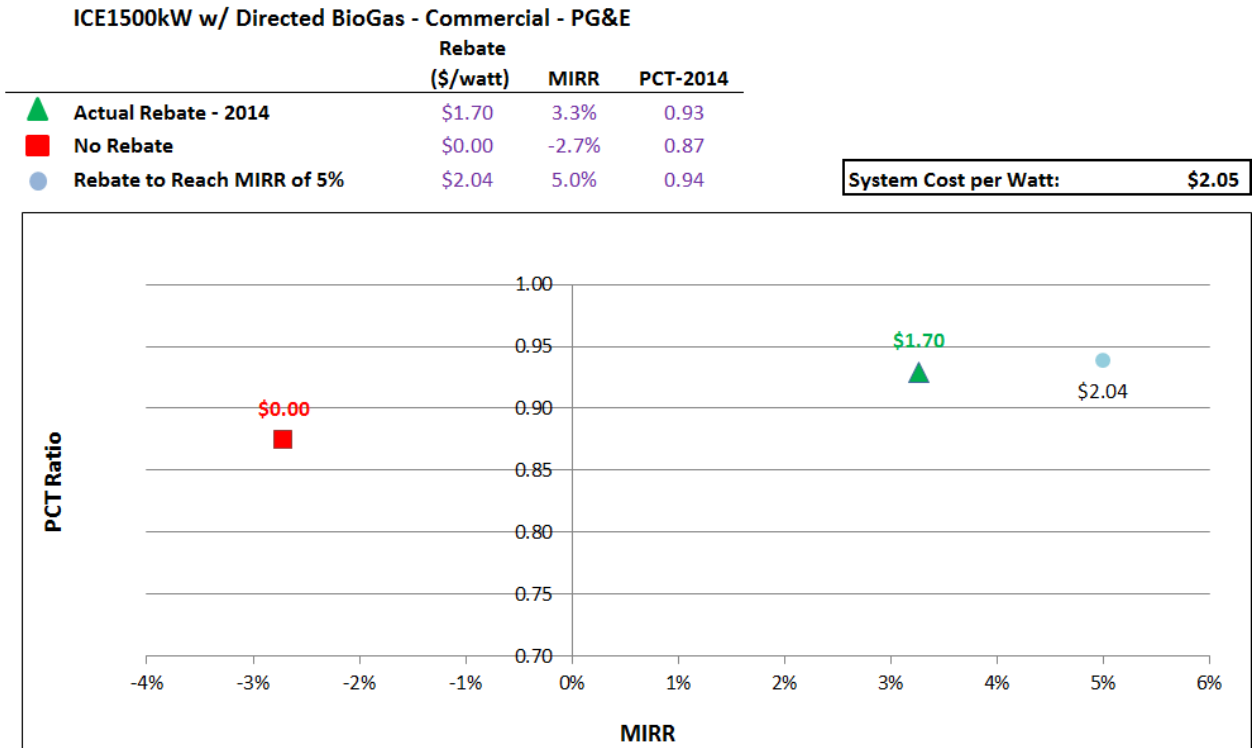


Figure 6-83 presents the results of a MIRR analysis on the 1500 kW IC engine fueled by directed biogas. With the expected 2014 PBI incentive, the MIRR reaches 3.3%. An incentive of \$2.04 per Watt would be needed to increase the project’s MIRR to 5%. Incentives to reach 6% or higher MIRR would exceed the cost of the system.



FIGURE 6-83: MIRR ANALYSIS FOR 1500 KW DIRECTED BIOGAS-FUELED IC ENGINE



MICROTURBINE TECHNOLOGIES

Commercial 200 kW Directed Biogas-Fueled Microturbine Participant Cost Test

Figure 6-84 shows the cost and benefit components of the PCT for a 200 kW microturbine fueled by directed biogas. As indicated by the PCT results, the 200 kW microturbine fueled by directed biogas fails to be cost effective to participants without incentives. The benefit-cost ratio, already low at 0.73 in 2014, increases to only 0.8 by 2024. High fueling costs work against the bill savings recognized by the project.



FIGURE 6-84: REPRESENTATIVE PCT RESULT FOR A DIRECTED BIOGAS 200 KW MICROTURBINE

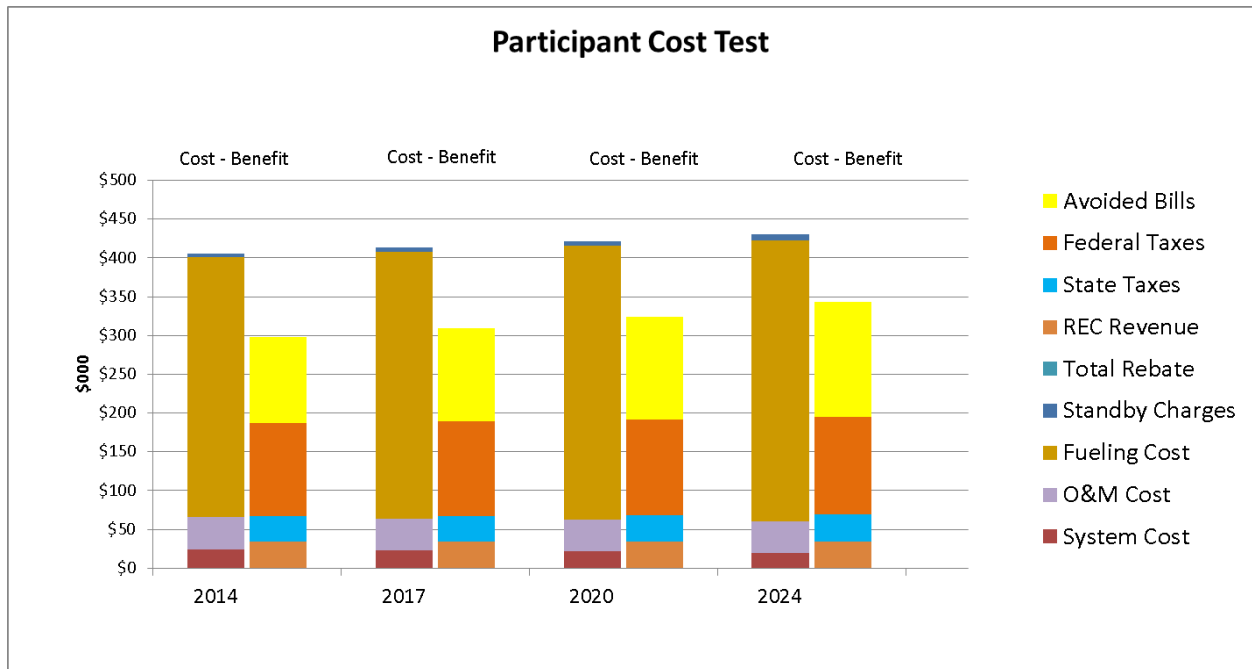
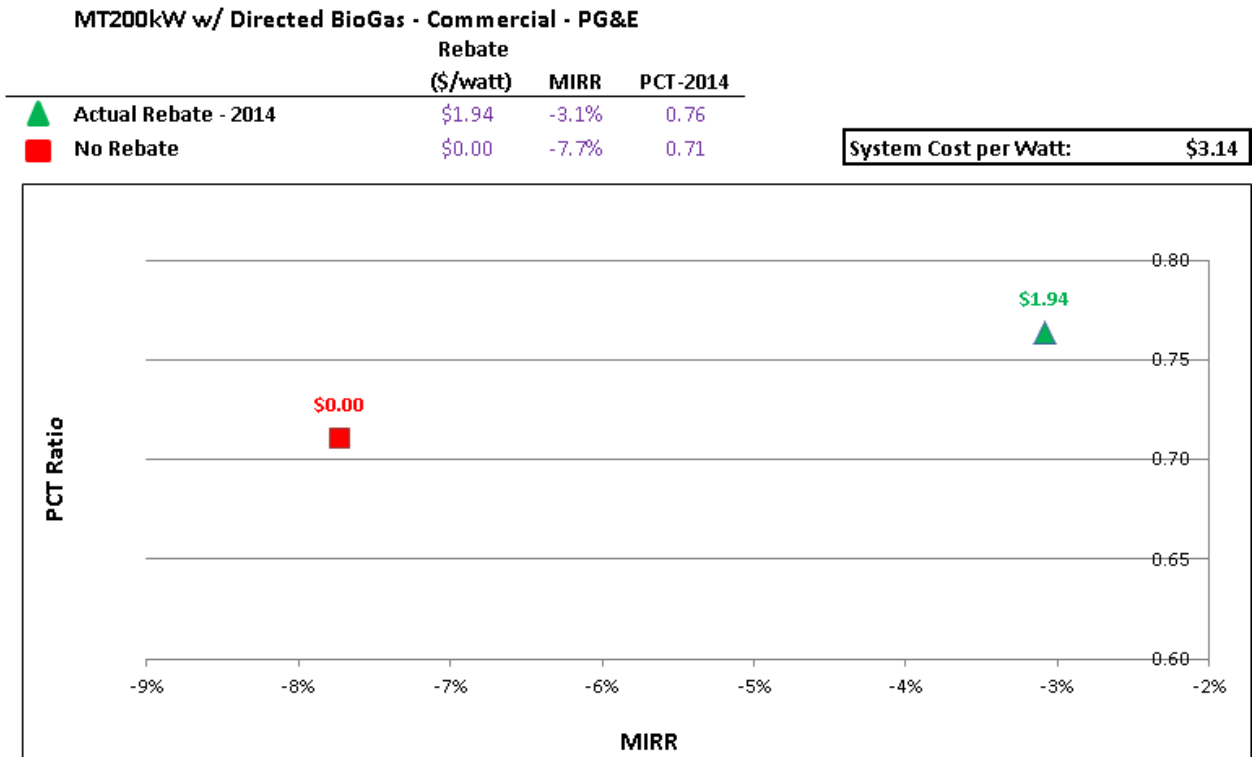


Figure 6-85 provides results of a MIRR analysis for the 200 kW microturbine fueled by directed biogas. Even with an expected 2014 PBI incentive, the project fails to achieve cost effectiveness.



FIGURE 6-85: MIRR ANALYSIS FOR 200 KW DIRECTED BIOGAS-FUELED MICROTURBINE



INTERNAL COMBUSTION ENGINE TECHNOLOGIES

Commercial 500 kW Onsite Biogas-Fueled IC Engine Participant Cost Test

Figure 6-86 shows the PCT cost and benefit results for a representative 500 kW IC engine fueled by onsite biogas. Like the other onsite biogas-fueled projects, the combination of no fueling costs, high bill savings, favorable federal and state tax treatment and REC revenue drives the project to be very cost effective even without SGIP incentives. The benefit-cost ratio extends from 1.25 in 2014 to 1.56 by 2024.



FIGURE 6-86: REPRESENTATIVE PARTICIPANT TEST RESULT FOR AN ONSITE BIOGAS 500 KW IC ENGINE

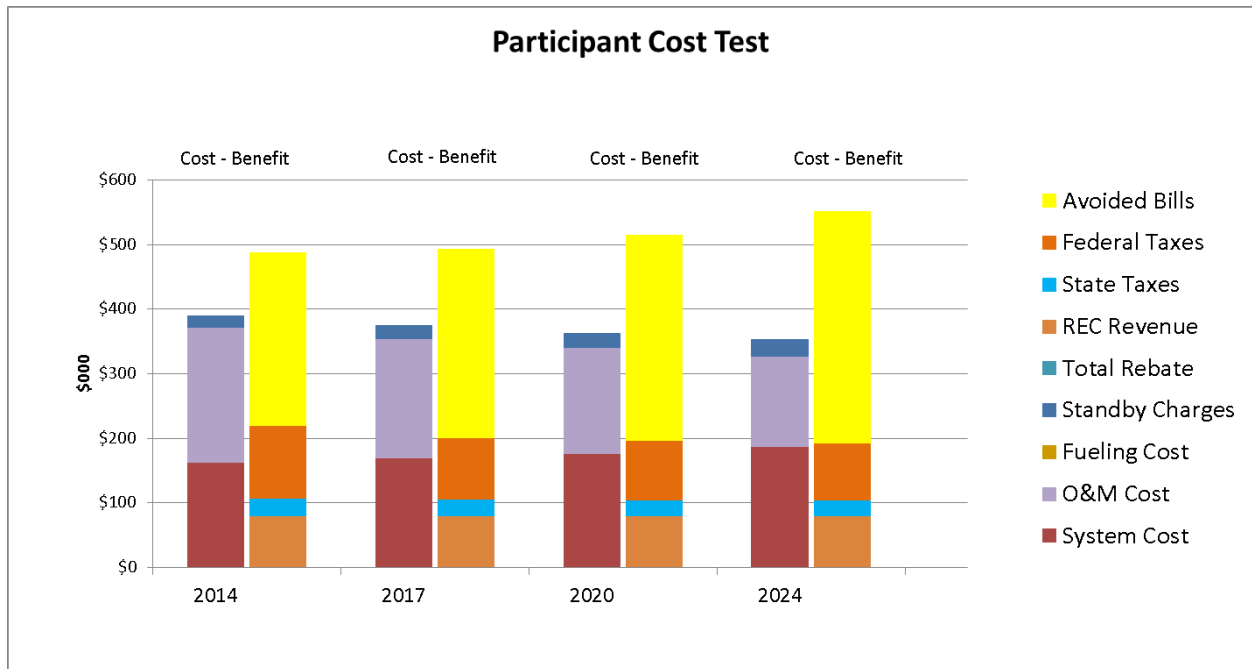
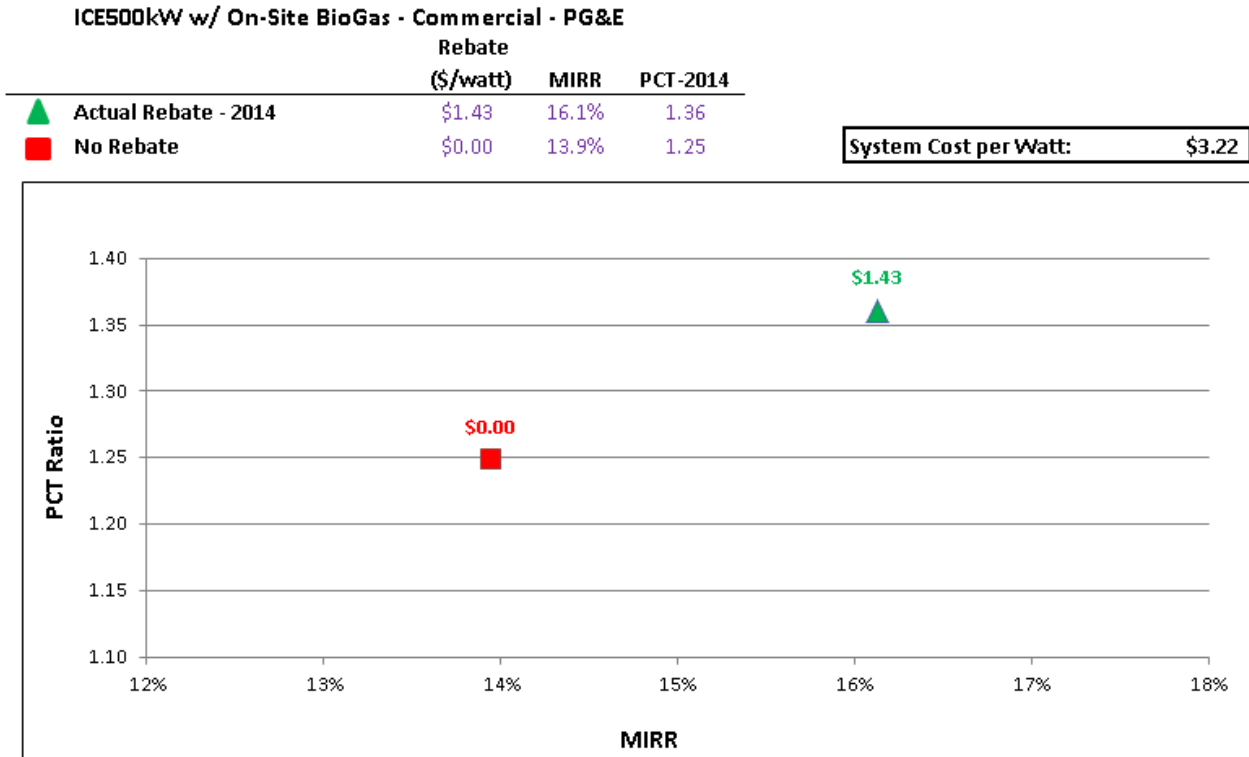


Figure 6-87 presents the MIRR analysis results for the 500 kW IC engine fueled by onsite biogas. Without incentives, the project MIRR is 13.9%. Under an expected 2014 PBI incentive, the project MIRR increases to 16.1%.



FIGURE 6-87: MIRR ANALYSIS FOR 500 KW ONSITE BIOGAS-FUELED IC ENGINE



Commercial 1500 kW Onsite Biogas-Fueled IC Engine Participant Cost Test

Figure 6-88 provides the PCT benefit and cost results for a representative 1500 kW IC engine fueled by onsite biogas. The 1500 kW IC engine project is very similar to the 500 kW project. The same factors that drove the favorable economic situation with the 500 kW engine are at play with the larger IC engine. The net result is a benefit-cost ratio in 2014 of 1.37 and in 2024 of 1.69; both without SGIP incentives.



FIGURE 6-88: REPRESENTATIVE PCT RESULT FOR AN ONSITE BIOGAS 1500 KW IC ENGINE

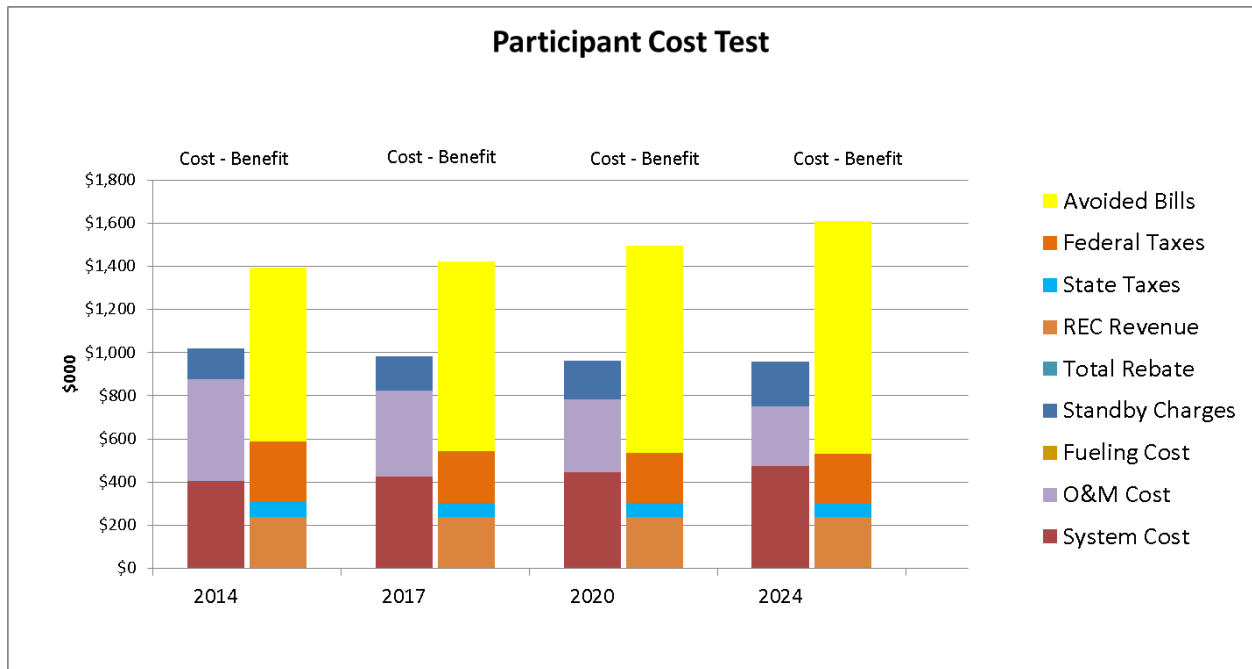
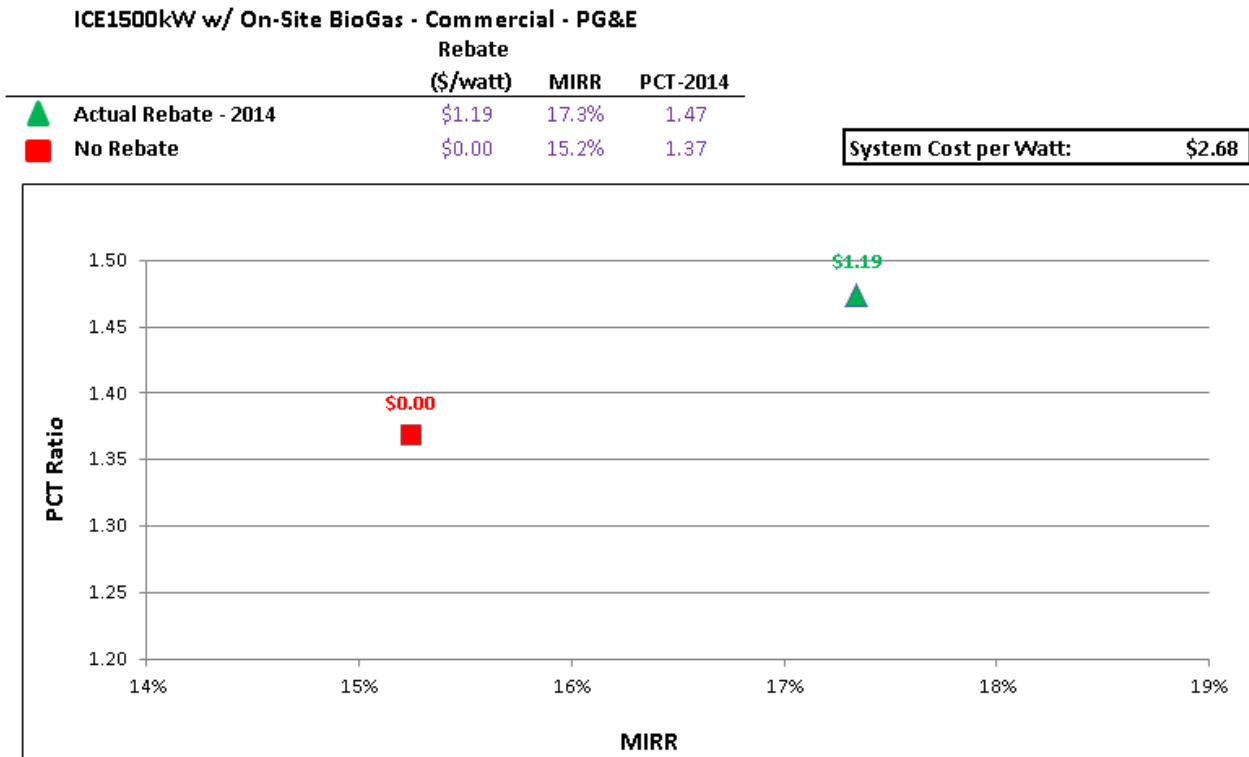


Figure 6-89 presents the MIRR analysis for the 1500 kW IC engine fueled by onsite biogas. The project MIRR without incentives is 15.2%. Under an expected 2014 PBI incentive, the project MIRR increases to 17.3%.



FIGURE 6-89: MIRR ANALYSIS FOR 1500 KW ONSITE BIOGAS-FUELED IC ENGINE



MICROTURBINE TECHNOLOGIES

Commercial 200 kW Onsite Biogas-Fueled Microturbine Participant Cost Test

Figure 6-90 shows the PCT results for a representative 200 kW microturbine fueled by onsite biogas. Although it has a lower power production capability per unit of system cost than either the IC engine or the larger gas turbines, the onsite biogas-fueled microturbine has very attractive economics. The benefit-cost ratios extend from 1.68 in 2014 to 1.98 in 2024 without incentives.



FIGURE 6-90: REPRESENTATIVE PARTICIPANT TEST RESULT FOR AN ONSITE BIOGAS 200 KW MICROTURBINE

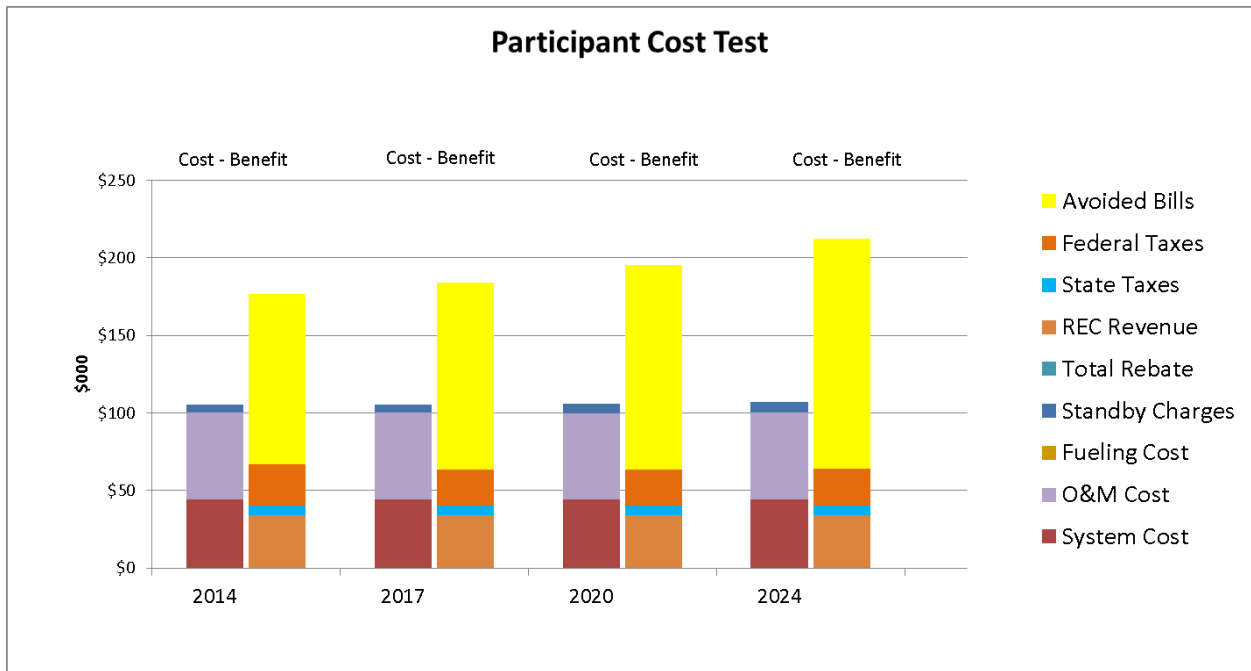
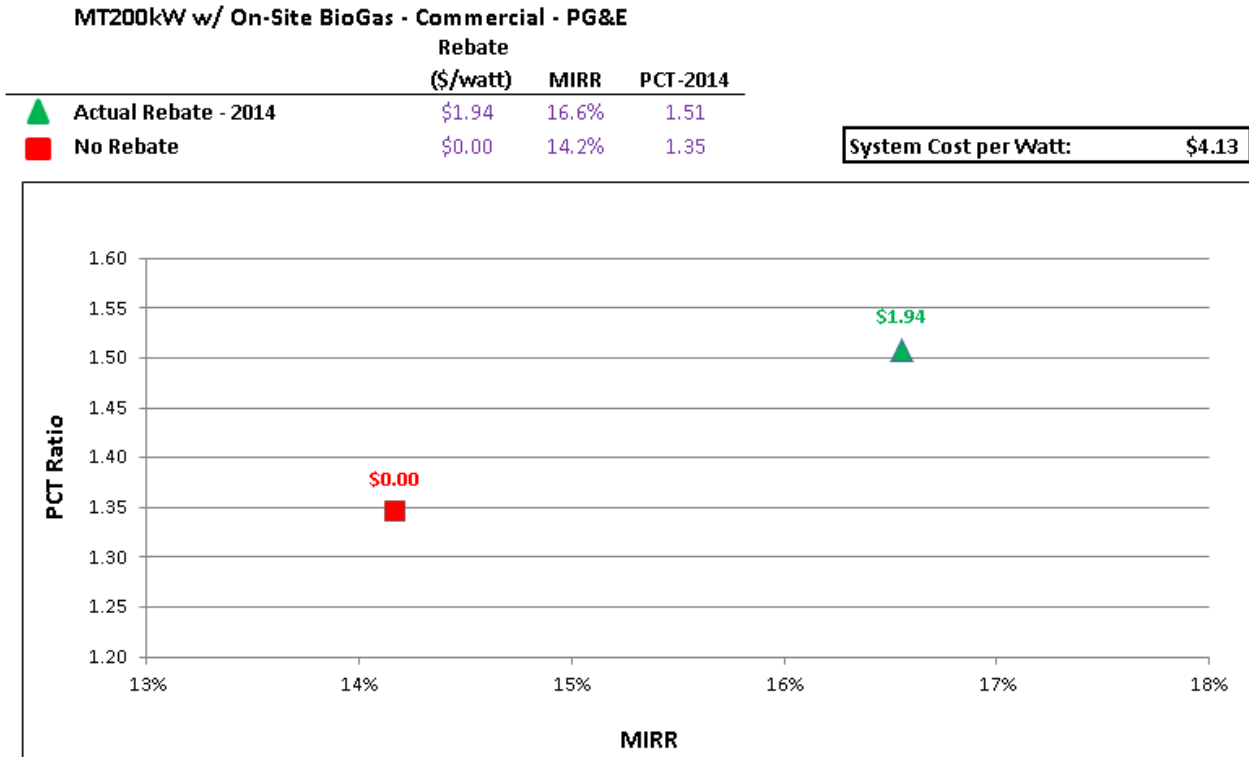


Figure 6-91 shows the results of the MIRR analysis on the 200 kW microturbine fueled by onsite biogas. Without incentives, the project MIRR is 14.2%. Under an expected 2014 PBI incentive, the project MIRR increases to 16.6%.



FIGURE 6-91: MIRR ANALYSIS FOR 200 KW ONSITE BIOGAS-FUELED MICROTURBINE



Summary of MIRR Results

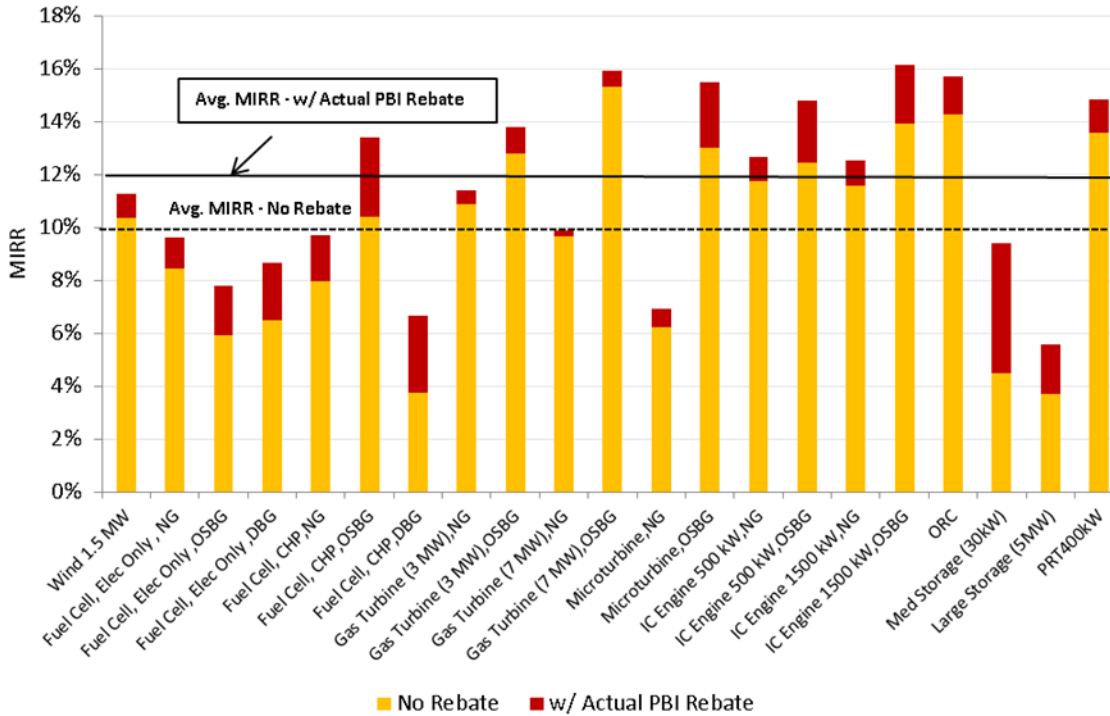
The MIRR analysis allows targeting of incentive levels to help create a “level playing field.” For technologies with equivalent risks, the MIRR feature of the SGIPce model can be used to calculate incentive levels that provide the same MIRR for the different SGIP technologies analyzed for this report.

Figure 6-92 is a summary of the statewide MIRR values for SGIP technologies at 2014 without incentives and with the expected levels of 2014 incentives provided by the SGIP. However, we only consider those SGIP technologies that have MIRR values that are greater than zero when no incentive is supplied by the program.

The dotted line represents the average MIRR value (approximately 10%) across the evaluated SGIP technologies when incentives are not provided.²³ The solid line represents the average MIRR value (approximately 12%) when those same SGIP technologies received incentive levels expected within SGIP in 2014.

²³ The 10% MIRR does not include the MIRR for technologies whose MIRR is negative without an incentive. The average MIRR is calculated as an arithmetic average giving each technology equal weight.

FIGURE 6-92: COMPARISON OF MIRR FOR SGIP TECHNOLOGIES WITHOUT INCENTIVES AND WITH 2014 INCENTIVES



Policy makers can use the MIRR results to estimate incentive levels for SGIP technologies necessary to reach a given return. If a MIRR value of 12% is determined to be the target level, the SGIPce model can provide a corresponding incentive level that matches the target MIRR.²⁴ While the MIRR analysis helps identify possible incentive levels that match target MIRR values, ultimately the selection of incentive values is a policy decision that must take into account market risk and uncertainty that cannot be captured accurately by the model.

6.4 PROGRAM ADMINISTRATOR COST TEST RESULTS

The PAC test examines the net costs of administrating a program made up of participant projects as resource options to the utility. It takes into account the costs incurred by the PA in operating the program (including incentive costs) and excludes any net costs incurred by the participant. The PAC represents the utility’s perspective on the net value of implementing the portfolio of projects making up the program.

Among the benefits allocated to the PAC are fuel and energy costs avoided from operation of the program, reductions in T&D system costs (including deferral of equipment installation to meet increased demand on the T&D system and reduced operating costs), and capacity savings. Note that for commercial customers, the 2014 SGIPce model evaluates the cost effectiveness of SGIP technologies

²⁴ The SGIPce model can generate incentive levels needed to achieve many different MIRR levels.

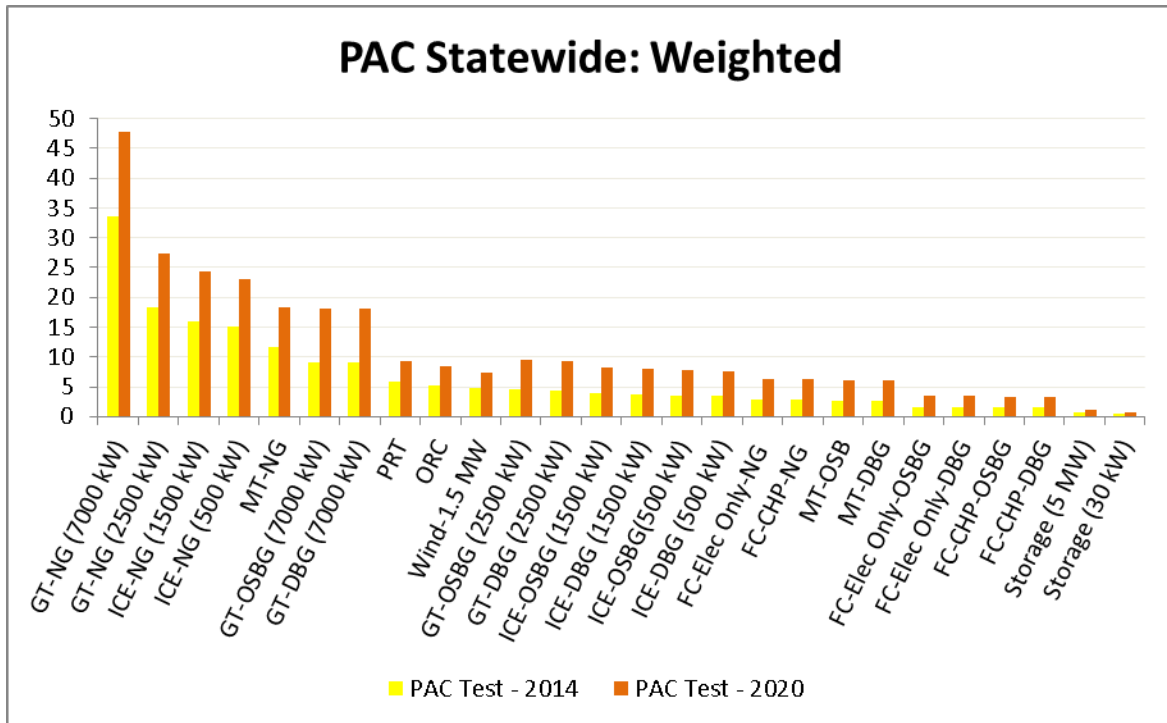


assuming that commercial customers purchase their gas on the wholesale market. Consequently, commercial customers who install SGIP technologies are not assumed to purchase additional utility natural gas; but instead buy natural gas on the spot market.

Table 6-10 lists the PAC test results for SGIP systems evaluated at the utility and statewide levels for 2014 and 2020. The 2014 results are presented using SGIP program incentives for 2014 as specified in the SGIP Handbook. The 2020 results use incentive levels forecast out to 2020 based on existing SGIP Handbook guidelines regarding annual declines in incentive levels by technology. Statewide results are provided on two basis: one where the PAC test results from each PA are weighted equally; and one where the PAC test results are weighted by the electricity sales of the respective IOU service territories.²⁵

Figure 6-93 summarizes the results of the PAC test in a bar chart.

FIGURE 6-93: PROGRAM ADMINISTRATOR COST RESULTS: 2014 AND 2020 (WEIGHTED)



The results presented in Figure 6-93 show that all evaluated SGIP technologies other than stand-alone energy storage have PAC benefit-cost ratios significantly higher than 1. These high PAC benefit to cost ratios result largely due to two factors occurring concurrently: high avoided electricity cost benefits

²⁵ Electricity sales taken from the CEC’s “California Energy Demand: 2014-2024 Final Forecast; Volume 2 (Electricity Demand by Utility Demand Area), January 2014. 2014 electricity sales were estimated at 103, 209 GWh (47.4%) for PG&E; 94,379 GWh (43.4%) for SCE and 20,103 GWh (9.2%) for SDG&E.



being generated at the same time the technology has low or zero fueling costs. As the avoided electricity costs (in the numerator) increase simultaneously with the fuel costs (in the denominator) dropping, the difference creates large benefit to cost ratios.

In addition, Figure 6-93 indicates that larger sized technologies in general have higher benefit to cost ratios. This results because the larger technologies provide a disproportionality greater amount of benefit generated for each dollar of incentive paid out to the technology. The SGIP reduces the amount of incentive paid as the rebated capacity of the technology increases. However, the benefits produced and allocated to the SGIP remain proportional to the total rebated capacity. Consequently, the larger sized technologies generate a greater amount of benefits than their smaller counterparts relative to the amount of incentive paid to the technology. The net result is that larger capacity SGIP technologies (which generate commensurately higher avoided cost benefits) with low or zero fuel costs and low incentive levels result in very high PAC benefit-to-cost ratios.

Stand-alone storage has lower PAC benefit-to-cost ratios. In the case of the modeled 5 MW system, the 2014 and 2020 ratios are 0.81 and 1.10, respectively. For the 30 kW system, the 2014 and 2020 ratios are 0.41 and 0.71, respectively. In general, stand-alone storage shows lower PAC benefit-to-cost ratios due to the lower amount of electricity system benefits (storage is only displacing electricity over a portion of the year and the demand reductions are only pronounced in the SDG&E service territory), there are “fueling” costs associated with charging the storage system and the incentives paid out to storage tend to be higher than for the other SGIP technologies.



TABLE 6-10: STATEWIDE SUMMARY OF COMMERCIAL SECTOR PA TEST RESULTS FOR 2014 AND 2020

Technology	SGIPce System Size (kW)	PG&E		SCE		SDG&E		Statewide - Equal		Statewide - Elec Sales	
		PA Test 2014	PA Test 2020	PA Test 2014	PA Test 2020	PA Test 2014	PA Test 2020	PA Test 2014	PA Test 2020	PA Test 2014	PA Test 2020
Wind Turbine											
- 1.5 MW	1,500	4.45	6.81	5.17	8.04	5.04	7.93	4.89	7.59	4.84	7.47
Fuel Cell - Electric Only											
- Natural gas	500	2.90	6.37	2.90	6.39	2.77	6.12	2.86	6.29	2.89	6.35
- Onsite biogas	500	1.56	3.45	1.55	3.45	1.47	3.27	1.53	3.39	1.55	3.43
- Directed biogas	500	1.56	3.45	1.55	3.45	1.47	3.27	1.53	3.39	1.55	3.43
Fuel Cell - CHP											
- Natural gas powered	1,200	2.73	5.95	3.03	6.66	2.80	6.16	2.85	6.26	2.87	6.29
- Onsite biogas	1,200	1.47	3.23	1.62	3.59	1.49	3.29	1.53	3.37	1.54	3.40
- Directed biogas	1,200	1.47	3.23	1.62	3.59	1.49	3.29	1.53	3.37	1.54	3.40
Gas Turbine - CHP											
- Natural gas powered (2500 kW)	2,500	15.47	22.70	20.62	31.20	20.36	31.18	18.82	28.36	18.28	27.37
- Onsite biogas (2500 kW)	2,500	4.18	8.67	4.88	10.30	4.58	9.76	4.55	9.58	4.54	9.51
- Directed biogas (2500 kW)	2,500	3.81	7.89	4.96	10.58	4.66	9.97	4.48	9.48	4.41	9.31
- Natural gas powered (7000 kW)	7,000	15.78	19.68	47.09	68.79	51.92	78.70	38.26	55.72	33.48	47.68
- Onsite biogas (7000 kW)	7,000	4.49	7.94	12.79	26.40	12.58	26.62	9.95	20.32	9.03	18.11
- Directed biogas (7000 kW)	7,000	4.49	7.94	12.79	26.40	12.58	26.62	9.95	20.32	9.03	18.11
Microturbine - CHP											
- Natural gas powered	200	11.68	18.30	11.59	18.22	11.95	19.02	11.74	18.51	11.67	18.34
- Onsite biogas	200	2.78	6.13	2.72	5.99	2.70	6.00	2.73	6.04	2.74	6.06
- Directed biogas	200	2.78	6.13	2.72	5.99	2.70	6.00	2.73	6.04	2.74	6.06
IC Engine - CHP											
- Natural gas powered (500 kW)	500	14.92	22.85	15.15	23.29	15.19	23.57	15.09	23.24	15.05	23.12
- Onsite biogas (500 kW)	500	3.61	7.73	3.58	7.69	3.53	7.64	3.58	7.69	3.59	7.71



Technology	SGIPce System Size (kW)	PG&E		SCE		SDG&E		Statewide - Equal		Statewide - Elec Sales	
		PA Test 2014	PA Test 2020	PA Test 2014	PA Test 2020	PA Test 2014	PA Test 2020	PA Test 2014	PA Test 2020	PA Test 2014	PA Test 2020
- Directed biogas (500 kW)	500	3.54	7.63	3.54	7.64	3.43	7.43	3.51	7.57	3.53	7.61
- Natural gas powered (1500 kW)	1,500	14.88	22.43	16.93	25.89	16.37	25.21	16.06	24.51	15.95	24.26
- Onsite biogas (1500 kW)	1,500	3.77	7.95	3.96	8.41	3.69	7.88	3.81	8.08	3.85	8.15
- Directed biogas (1500 kW)	1,500	3.58	7.57	4.00	8.56	3.71	7.95	3.76	8.03	3.78	8.05
Organic Rankine Cycle											
- 500 kW	500	5.31	8.47	5.29	8.44	5.19	8.30	5.26	8.40	5.29	8.44
Storage											
- Med storage	30	0.41	0.71	0.41	0.71	0.43	0.74	0.42	0.72	0.41	0.71
- Larger storage	5,000	0.81	1.10	0.80	1.09	0.85	1.16	0.82	1.12	0.81	1.10
PRT											
- 400 kW	400	5.89	9.26	5.85	9.20	5.76	9.07	5.83	9.18	5.86	9.21

APPENDIX A INVESTIGATED SGIP TECHNOLOGIES

A.1 INTRODUCTION

The technical foundation of the cost-effectiveness model is a set of technology-specific workbooks on the different SGIP technologies investigated in this 2015 Study. The workbooks represent compiled performance and cost data from a variety of sources, including the CPUC's SGIP. Secondary sources of information come from the CHP industry, as well as academic institutions, national labs, federal or state energy programs, or other energy research organizations. This appendix explains the methods used for estimating and forecasting costs. It also identifies the sources, assumptions, and results for each individual SGIP technology. SGIP technologies examined in the study include fuel cells, small gas turbines, IC engines, microturbines, wind energy systems, Organic Rankine Cycle systems, pressure reduction turbines, and battery storage.

This appendix begins with a discussion of learning curves and how learning curves are used to project future capital costs of SGIP technologies. Following the discussion on learning curves, we present a discussion on biogas collection and processing costs. A number of SGIP systems can be powered by natural gas or by biogas derived from anaerobic digestion processes (e.g., dairy digesters, landfill gas collection systems, and wastewater treatment facilities). Biogas collection and processing costs are treated independently as they cut across the different SGIP technologies.

Learning Curves and Progress Ratios

The overarching concept behind learning curves is that companies operating in competitive markets can “learn” to manufacture goods more efficiently as they gain experience in the manufacturing and production of the goods. As a company sells more units of some technology or product “X,” it learns ways to decrease production costs. These lower production costs can be transferred to the consumer as lower prices. The level of learning is quantified by a reduction in costs while the metric for gained experience is the total number of units sold.

Learning curves represent an established method for forecasting future performance or costs of technologies. Learning curves fit empirical performance or cost data into trends using power equations. One of the most famous learning curves is Moore's law. Developed in the semiconductor industry, Moore's law accurately predicted “the number of transistors incorporated in a chip will approximately double every 24 months.”¹

Learning curves are based on the premise of “learning by doing.” As technologies undergo development, manufacturers find ways to refine the production process and reduce equipment costs. Increased

1 Moore's Law and Intel Innovation, from <http://www.intel.com/content/www/us/en/history/museum-gordon-moore-law.html>



production also leads to economies of scale. Market competition encourages further innovation and improvements. As a result, future units will cost less to produce due to improved learning.

Mathematically, future prices of a product can be related to its volume of production through a power equation:

$$\text{Price at year } t = P_0 * X^{-E}$$

P_0 is the price at one unit of cumulative production or sales of the product and “X” is the cumulative production or sales in year t divided by the production in year zero. “E” represents the “experience” parameter and determines the steepness of the curve. Large values of E indicate a steep curve with a high learning rate (LR). In this manner, learning rate is a metric for estimating the extent to which technology costs are reduced for each doubling of production.

The progress ratio (PR) is another term used when describing learning curves. The progress ratio is defined mathematically in relationship to the learning curve and the experience parameter (E) as follows:

$$PR = 2^{-E}$$

$$LR = 1 - PR$$

The learning rate is the percentage of expected price drop for a doubling of cumulative production. It is defined as one minus the progress ratio. A learning rate of zero represents no change in the cost of the system over time, regardless of how many units are manufactured. In essence, there is no “learning by doing.” A learning rate of 0.2 indicates that, based on projected shipment volumes, the cost of the unit would be reduced by 20% with doubling of cumulative production.

In the next sections, we show how to develop learning rates and progress ratios and then apply them to project future technology costs. We use IC engines as an example.

Cumulative Production Volumes

In developing learning rates and progress ratios, the starting point is cumulative production volumes of the technology being examined. Table A-1 presents information on IC engines sold in the size range of 500 kW to 1 MW for North America from 2006 to 2013. Table A-1 visually depicts the cumulative volume production information using 500 kW capacity as a proxy for the 500 kW to 1 MW engines. As shown in the chart, the cumulative growth rate in 500 kW IC engines looks to be a linear growth curve. When we fit a linear curve to the data, we found the linear curve fit provided returned a coefficient of determination (R^2) close to 0.97; indicating a good fit. Not all SGIP technologies will have a linear growth. Fuel cells and battery storage technologies for example, may very well show geometric or



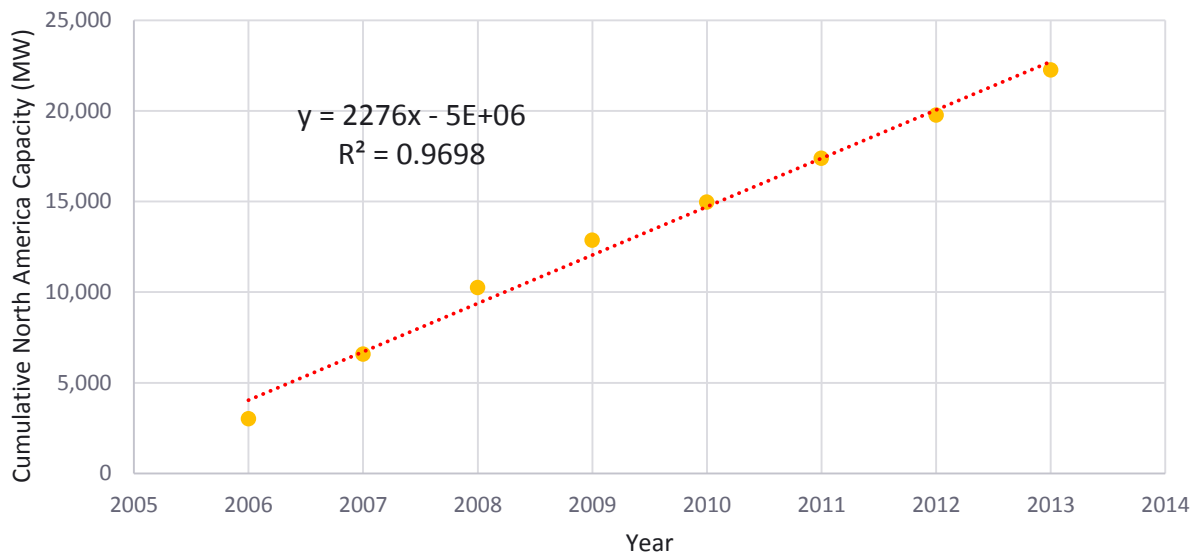
exponential growth rates. Our approach is to fit the cumulative capacity growth data to the appropriate curves.

TABLE A-1: PRODUCTION VOLUMES FOR 500 KW IC ENGINES

Year	Units Ordered	Total Engine Capacity (MW)	Average Engine Capacity per Order (MW)	North American Orders	North America Annual Capacity (MW)	North America Cumulative Capacity (MW)
2006	17,614	11,840	0.67	4,466	3,002	3,002
2007	19,339	13,405	0.69	5,161	3,577	6,579
2008	21,376	16,151	0.76	4,852	3,666	10,245
2009	17,155	13,013	0.76	3,447	2,615	12,860
2010	17,674	13,457	0.76	2,764	2,105	14,965
2011	17,814	13,100	0.74	3,281	2,413	17,377
2012	17,636	13,280	0.75	3,160	2,379	19,757
2013	18,090	13,335	0.74	3,389	2,498	22,255

Source: Diesel & Gas Turbine Worldwide Surveys (2007-2014).

FIGURE A-1: GROWTH IN CUMULATIVE CAPACITY OF 500 KW IC ENGINES





Technology Price Data

Once cumulative growth data are collected, the next step is to obtain cost data that match the cumulative growth data for the examined technology. Table A-2 is a summary of estimated installed costs for 500 kW IC engines from 2006 to 2013. The costs have been adjusted to 2013 dollars using the Consumer Price Index (CPI).

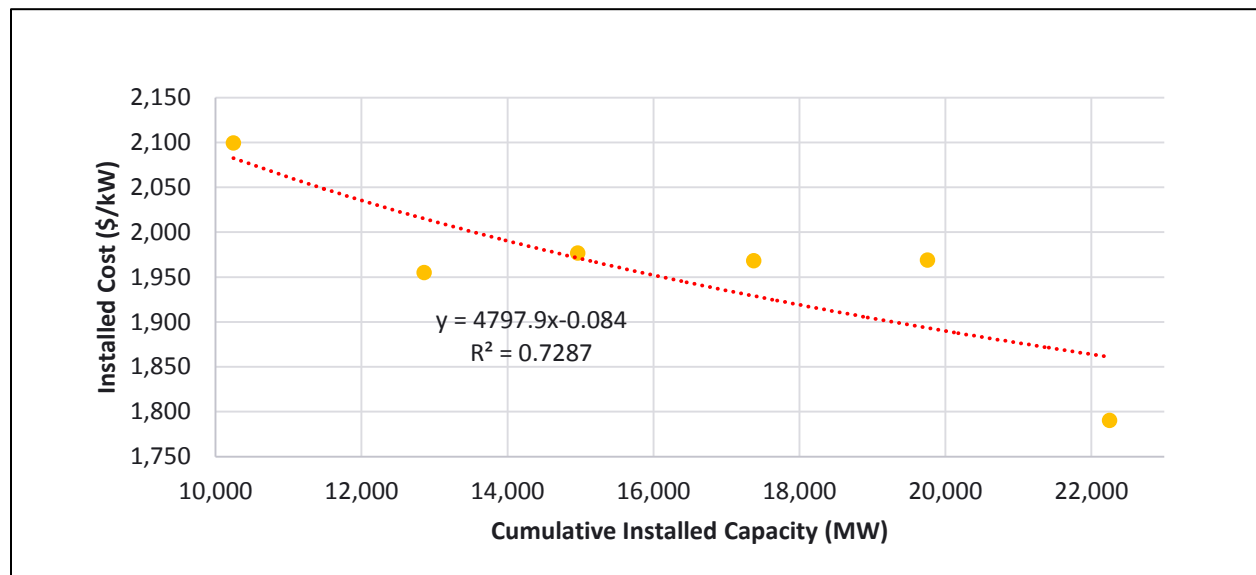
TABLE A-2: ESTIMATED INSTALLED COSTS OF 500 KW IC ENGINES 2006 TO 2013 IN 2013\$

500kW Case				
Year	Capacity (MW)	Cumulative Capacity (MW)	Installed Cost (\$/kW)	Installed Cost (2013 \$/kW)
2006	3,002	3,002	1,250	1,444
2007	3,577	6,579	1,378	1,548
2008	3,666	10,245	1,940	2,099
2009	2,615	12,860	1,800	1,955
2010	2,105	14,965	1,850	1,976
2011	2,413	17,377	1,900	1,968
2012	2,379	19,757	1,940	1,968
2013	2,498	22,255	1,790	1,790

Sources: Diesel & Gas Turbine Worldwide Surveys (2007-2014), US EPA Catalog of CHP Technologies Sep 2014, Commercial and Industrial CHP Technology Cost and Performance Data Analysis for EIA, June 2010, ICF International, Inc. Report - CHP Policy Analysis and 2011-2030 Market Assessment Report, Feb 2012 (for CEC)

Figure A-2 shows that as volume production of 500 kW IC engines increased; there was an associated drop in installed costs, which suggests a learning curve.

FIGURE A-2: DROP IN INSTALLED COST OF 500 KW IC ENGINES WITH INCREASED PRODUCTION





From the power relationship, we can obtain the parameter E, which we need to calculate the learning rate and the progress ratio.

$$\text{Price at year } t = P_0 * X^{-E}$$

Based on a regression fit of the power curve, we find that E in the 500 kW IC engine example is equal to 0.084. From the definition of learning rate and progress ratio, we have:

$$\begin{aligned} \text{LR} &= 1 - \text{PR} \\ \text{PR} &= 2^{-E} \end{aligned}$$

Using the value obtained from the power curve, we then end up with the following values for the learning rate and progress ratio.

E	-0.084
LR	6%
PR	94%

Treatment of Biogas Collection and Clean-Up Costs

Biogas refers to the methane-rich gas that is produced from the naturally-occurring anaerobic biological breakdown (or digestion) of organic materials such as manure or food processing wastes. Biogas is a mixture of methane, carbon dioxide, water, and a variety of other trace compounds. Depending on the source of the biogas and its associated methane content, biogas represents a renewable fuel source with an energy content of approximately half that of natural gas.² Biogas has been used as a fuel resource for hundreds of years but saw increased use for electricity generation purposes in the United States in the mid-1980s following passage of the Public Utility Regulatory Policies Act (PURPA) of 1978.³ Common sources of biogas include landfills, wastewater treatment facilities, food processing plants, and livestock operations (e.g., dairies, swine operations, etc.). Since the startup of the SGIP in 2001, over 50 SGIP projects have been installed that use onsite biogas as a fuel source.

Natural gas prices implicitly reflect costs associated with collecting natural gas from underground reservoirs and processing it to remove water and other contaminants. Similarly, biogas must be collected and processed before use in SGIP technologies. Unlike natural gas resources, it is necessary to also estimate the costs associated with the anaerobic processes that biologically convert the solid or liquid biomass resources to biogas. Biogas conversion costs are not considered as project capital costs

2 Simons, G. and Z. Zhang, "Distributed Generation from Biogas in California," Interconnecting Distributed Generation Conference, March 21, 2001

3 Lusk, P. "Methane Recovery from Animal Manures: The Current Opportunities Casebook," for the National Renewable Energy Laboratory, NREL/SR-580-25145, September 1998



for landfills and wastewater treatment facilities in this study. In the case of both landfills and wastewater treatment facilities, the biological conversion systems are already in place and do not represent costs that must be borne by the biogas-to-energy project.⁴ Conversely, biogas conversion systems (e.g., digesters) are not already in place at dairies or food processing facilities. Consequently, we incorporated the costs of biogas gas collection and conversion systems as part of the overall biogas to energy project costs for energy applications at livestock (dairies and swine operations) and food processing facilities.

A biogas model was developed to estimate the added costs associated with capturing, and cleaning biogas at the source (e.g., dairy, landfill, wastewater treatment facility, etc.). To develop cost estimates, we developed estimates of the flow of biogas needed for the project. The expected input fuel gas flow rate of each technology was estimated as follows:

$$kWh_{in} = \frac{(kW_{rated}) * (8,760) * (CF)}{\eta_{elec}}$$

The energy required to fuel the system for one year (kWh_{in}) is the product of the rated capacity of the system (kW_{rated}), the numbers of hours in the year (8,760) and the average annual capacity factor (CF) of the technology divided by its electrical efficiency (η_{elec}). Capacity factors and electrical efficiency values were based on metered values obtained from SGIP facilities and then compared to other reported test data in order to provide sound engineering estimates of representative biogas flows for each technology.

Biogas flowrates are then estimated based on:

$$SCFD_{BioGasIn} = \frac{(kWh_{in}) * \left(3,412 \frac{Btu}{kWh}\right)}{\left(600 \frac{Btu}{SCF}\right) * \left(365 \frac{days}{year}\right)}$$

The daily flow of biogas ($SCFD_{BioGasIn}$) required for each technology is the product of the required energy input (kWh_{in}) converted to Btu divided by the energy content of the biogas and the number of days in the year. For this study, we assumed biogas had an average higher heating value (HHV) of 600 Btu per standard cubic foot (SCF). Once daily biogas flow rates were established for each technology, capital and operations/maintenance costs were calculated for the appropriate anaerobic digestion, gas capture, and cleanup processes. As a result, biogas collection and processing costs could be provided on a capital and O&M basis or provided in a unit price per energy (i.e., \$ per million Btu), similar to natural gas.

For our analysis, we assume the biomass substrate is animal manure (dairy, swine or poultry) and the gas conditioning/cleanup involves the removal of hydrogen sulfide. Removal of hydrogen sulfide is necessary before biogas is used in internal combustion engines, microturbines, gas turbines, and fuel

4 While the biogas conversion systems are considered to be in place, biogas treatment costs must still be considered for both landfills and wastewater treatment facilities if the biogas is to be used as a fuel.



cells because it is highly corrosive. This severely reduces equipment life, increases O&M costs and negatively impacts a project’s revenue generation potential. For IC engine, microturbine, and gas turbine applications, hydrogen sulfide must be removed to less than 1,000 parts per million (ppm), while for fuel cells it must be reduced to less than 1 ppm by volume.

Table A-3 shows the estimated gas conditioning/cleanup costs used in the cost-effectiveness model for on-site biogas cases. The cost numbers are an average of several cost sources. The costs are highly dependent on the quantity of biogas being processed and contaminants being removed. There are several removal techniques but the most frequently used and most cost-effective is the use of iron-oxide sponge in IC engine, microturbine, and gas turbine applications. Additional techniques are used to clean up the biogas when it is used in fuel cell applications so as to further remove the hydrogen sulfide and reduce poisoning of the stack. The differences in clean-up costs reflect the greater rigor in the removal of the hydrogen sulfide.

TABLE A-3: ESTIMATED BIOGAS CLEANUP AND COLLECTION COSTS

Cost Component	Internal Combustion Engines	Gas Turbines	Microturbines	Fuel Cells
Biogas Conditioning/Cleanup (\$/kW)	387	504	744	807
Biogas Collection costs (\$/kW)	230	230	230	230
O&M costs (\$/kWh)	0.046	0.005	0.008	0.110

Sources: Angela McEliece, RCM International LLC. Personal Communication; Encina Wastewater Authority, Energy and Emissions Strategic Plan; Howard Curren AWTP Biogas Use Study; and Ndegwa et al Anaerobic Digestion: Biogas Utilization and Cleanup.

The gas collection costs are restricted to only those costs related to collection of the biogas once it has been produced from the anaerobic process. Sunk costs such as the digester system or cover are not included as these costs would have been incurred regardless of the generation component. Gas collection costs therefore include only infrastructure costs such as site piping to move the gas to the generator housing and instrumentation costs. These costs are highly site-specific and variable. The costs shown are averages of different literature sources and from personal communication with project developers.^{5,6} For consistency, the estimated O&M costs are based on representative biogas projects in California and are based on 10-year averages that reflect the gas conditioning/cleanup costs.

The following sub-sections describe the development of technology-specific capital costs, O&M costs, growth rates, and learning rates.

5 Angela McEliece, RCM International LLC. Personal Communication. 2014

6 Bill Idlewine, Martin Machinery LLC. 2014

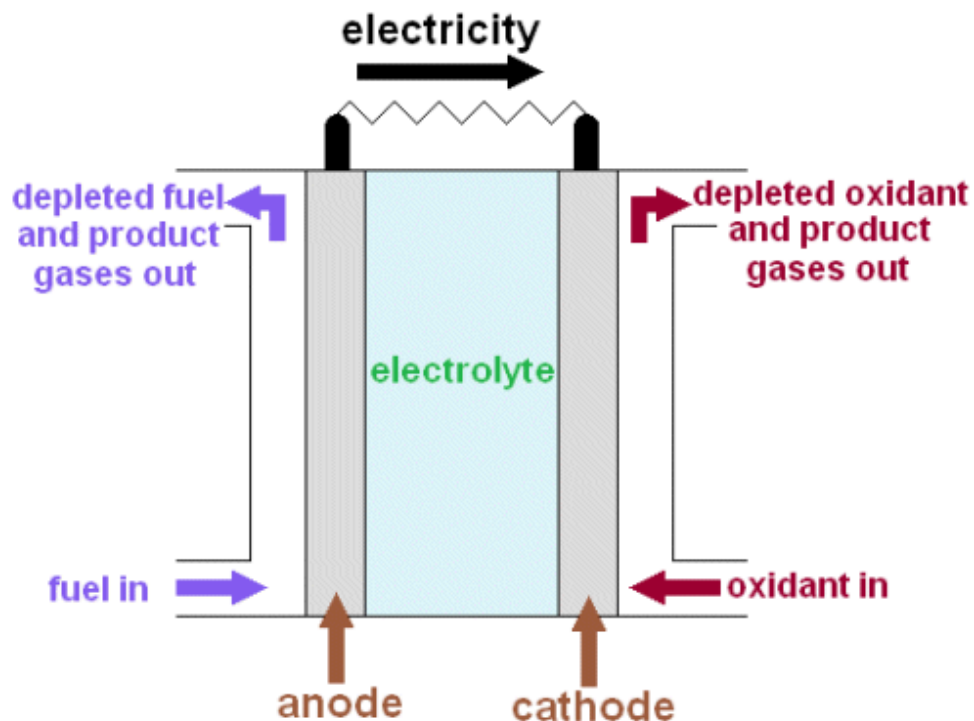
A.2 FUEL CELLS

This sub-section provides a fuel cell technology summary and describes the sources of capital and O&M cost estimates used in the SGIPce model.

Technology Summary

Fuel cells are electro-chemical devices that generate electricity by means of a chemical/oxidation reaction. Broadly speaking, all fuel cells consist of two electrodes (anode and cathode) separated by an electrolyte (solid or liquid). Fuel cells are typically categorized by the type of electrolyte that carries an electrically charged particle from one electrode to another. The overall operating principles of fuel cell operation are summarized in Figure A-3.

FIGURE A-3: GENERIC FUEL CELL SCHEMATIC



Source: green-planet-solar-energy.com

While fuel cells are usually considered an emerging technology in the SGIP, the history of fuel cells spans many years. During the 1950s General Electric was credited with the invention of the first proton exchange membrane fuel cell (PEMFC). International Fuel Cells (which became UTC Power) later developed a 1.5 kW alkaline fuel cell (AFC) for use in the Apollo space missions.⁷ Generally speaking, commercialization of fuel cells for large stationary applications began in the 1990s. Other fuel cell

⁷ <http://www.fuelcelltoday.com/history>



technology types include solid oxide fuel cells (SOFCs), molten carbonate fuel cells (MCFCs), and phosphoric acid fuel cells (PAFCs).

Within the SGIP, fuel cells are categorized by their ability to employ useful heat recovery to serve an on-site thermal load. Fuel cells that recover useful heat to serve thermal loads are considered CHP fuel cells whereas fuel cell technologies that have no useful heat available to serve on-site thermal loads are considered electric-only fuel cells. CHP fuel cells in the SGIP are typically installed at large commercial or industrial facilities like hotels, hospitals, military bases, grocery stores, food processing facilities, or university campuses that have a sufficiently high electrical and thermal load. The CHP fuel cell technology types deployed in the SGIP primarily include PAFCs and MCFCs.

Electric-only fuel cells utilize a large portion of their heat energy internally and therefore do not serve on-site thermal loads. Due to their internal utilization of thermal energy, electric-only fuel cells typically achieve greater electrical conversion efficiencies than CHP fuel cells. SOFCs are the only technology type in the SGIP that operates exclusively as electric-only, however any fuel cell technology that meets minimum performance requirements is able to operate without useful heat recovery (i.e., electric-only).

Global shipments of stationary fuel cells reached almost 125 MW in 2012.⁸ As of December 31, 2013, the SGIP had provided incentives to 238 fuel cell projects representing almost 91 MW of rebated capacity.⁹ The average fuel cell generator is typically 300-500 kW but SGIP projects often consist of several units which combined can total over 1 MW of capacity. Fuel cell projects in the SGIP are primarily fueled by natural gas, onsite biogas, and directed biogas. Onsite biogas applications include food processing facilities and waste water treatment plants. In rare cases, SGIP fuel cell projects are directly fueled by reformed hydrogen gas.

Fuel cells are often selected over traditional combustion-based self-generation technologies for their relatively higher electrical efficiencies. The following sub-section explores the operating characteristics of CHP and electric-only fuel cells.

Technology Operating Characteristics

This sub-section provides a description of the operating characteristics of CHP and electric-only fuel cells.

Typical Efficiencies

Representative electrical conversion efficiencies for various fuel cell technology types are summarized in Table A-4.

8 http://www.fuelcelltoday.com/media/1889744/fct_review_2013.pdf

9 Total project counts and rebated capacities include 5 kW PEMFCs. These fuel cell technologies are not studied in this model but were included in the original 2010 model.



TABLE A-4: REPRESENTATIVE FUEL CELL ELECTRICAL CONVERSION EFFICIENCIES

Fuel Cell Technology Type	Electrical Conversion Efficiency (LHV*)	Source
MCFC – CHP	45 - 49%	http://www.fuelcellenergy.com/assets/PID000152_FCE_DFC1500_r7_hires.pdf
PAFC – CHP	41 - 42%	http://www.doosanfuelcell.com/attach_files/link/PureCell%20Model%20400%20Datasheet.pdf
PEMFC – CHP	42 - 46%	http://www.ballard.com/files/PDF/Distributed_Generation/CLEARgen_Spec_Sheet.pdf
SOFC – Electric Only	52 - 60%	http://www.bloomenergy.com/fuel-cell/es-5710-data-sheet/

* LHV = Lower Heating Value

During 2013, the average electrical conversion efficiencies observed in the SGIP were 35% for CHP fuel cells and 53% for electric-only fuel cells. A distinguishing characteristic of fuel cells is that the electrical conversion efficiency is largely a function of the project life due to degradation in the fuel cell “stack”.¹⁰ The stack is typically replaced at least once during the life of a fuel cell project to mitigate the effects of degradation. Based on SGIP data, the average fuel cell electrical conversion efficiency during first year operations is 43% for CHP fuel cells and 54% for electric-only fuel cells. These first-year efficiencies are used in the cost-effectiveness model.

Useful Waste Heat Recovery

CHP fuel cells can recover useful heat to serve on-site heating and/or cooling loads. Maximum heat recovery rates are summarized in Table A-5.

TABLE A-5: MAXIMUM FUEL CELL HEAT OUTPUT

Fuel Cell Technology Type	Maximum Heat Recovery Rate (MMBtu/h)	Source
MCFC – CHP	2.2 – 3.7	http://www.fuelcellenergy.com/assets/PID000152_FCE_DFC1500_r7_hires.pdf
PAFC – CHP	1.5 – 1.8	http://www.doosanfuelcell.com/attach_files/link/PureCell%20Model%20400%20Datasheet.pdf
PEMFC – CHP	3.24	http://www.ballard.com/files/PDF/Distributed_Generation/CLEARgen_Spec_Sheet.pdf

¹⁰ A single fuel cell does not produce enough power to be suitable for large stationary applications. Consequently, several fuel cells are combined into a “stack” and electronically connected to generate a greater power output.



Actual useful heat recovery rates are dependent on the actual thermal demand at the facility and may be lower than the values shown in Table A-5. During 2013, the average observed useful heat recovery rate was approximately 2 MBtu/kWh. Electric-only fuel cells utilize a large portion of thermal energy internally and, therefore, do not serve the facility's thermal load.

Greenhouse Gas and Criteria Air Pollution Emissions

A distinguishing characteristic of fuel cells is their relatively low criteria air emission rates compared to traditional combustion-based self-generation technologies. Typical criteria emission rates are summarized in Table A-6.

TABLE A-6: FUEL CELL AIR POLLUTANT EMISSION RATES

Technology	CO₂ lb/MWh	NO_x lb/MWh	PM₁₀ lb/MWh
CHP	984	0.010	0.00002
Electric-only	783	0.002	0.00002

Sources: FuelCell Energy, Bloom Energy

Relatively low criteria air pollutant emission rates make fuel cells particularly attractive to project developers considering projects in air quality districts with stringent citing requirements. CHP fuel cells achieve additional air emission reductions when waste heat is used to avoid boiler and/or electric chiller operations.

Generation Profiles and Ramp Rates

Fuel cells are typically installed in baseload (i.e., 24/7) configurations although certain fuel cell types are able to follow loads. Ideally facilities have enough electrical demand that the load will never fully disappear if the generator is running during all hours of the day.

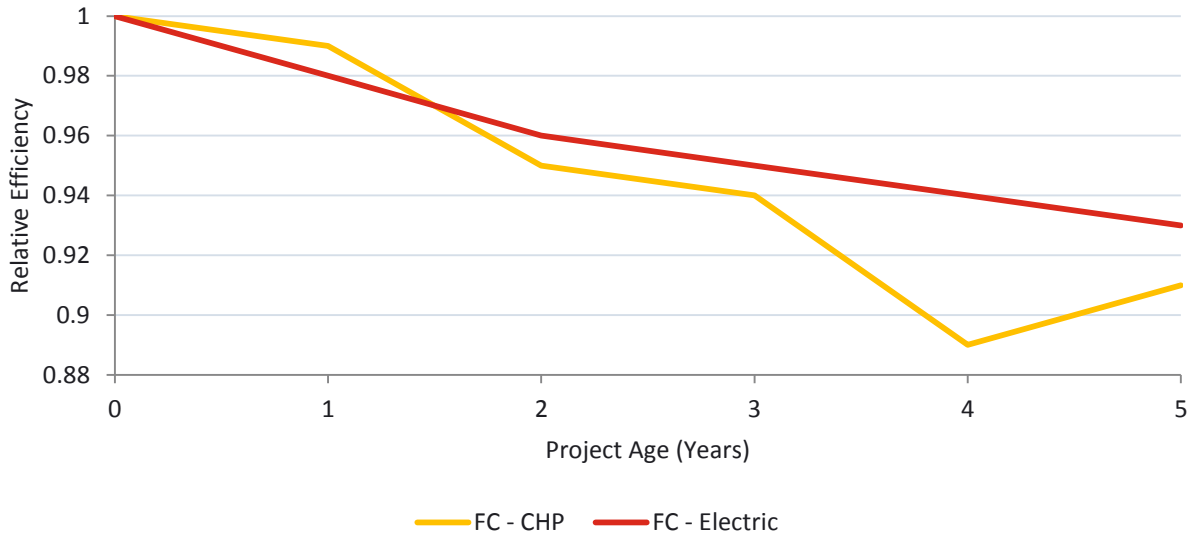
Lifetime and Performance over Time

Figure A-4 illustrates degradation in fuel cells as a function of age.¹¹

¹¹ Note that fuel cell degradation is limited to a project age of five years due to lack of longer term performance data on fuel cells.



FIGURE A-4: FUEL CELL DEGRADATION IN THE SGIP



A typical fuel cell installation is expected to last 20 years; however, certain components must be replaced sooner than 20 years. Notably, the fuel cell stack must be replaced at least once every 10 years due to degradation effects. After five years of operation, electrical conversion efficiencies are 5-10% lower than at the start of life.

Current Technology Capital Costs

Stationary fuel cell prices vary by fuel cell type (SOFC, PEMFC, PAFC, and MCFC) and size. Due to the immaturity of this technology, cost uncertainty is high. For the purposes of this analysis, there are only three costs categories: Fuel Cells CHP (1.2 MW), Fuel Cells CHP (500 kW), and Fuel Cells Electric-Only (500 kW). The 1.2 MW and 500 kW CHP categories are based on literature sources for PAFC and MCFCs while the electric only 500 kW category is reflective of the SOFC technology. In 2011, the DOE presented installed costs for CHP systems from 100 kW to 3 MW to be in the \$3,500 - \$5,500 per kW range.¹² This estimate is broadly consistent with the Oak Ridge National Lab 2011 estimates of \$4,700 per kW for a 400 kW PAFC and \$3,500 per kW for a 3 MW MCFC.¹³ The DOE 2011 estimate was forecast to decrease to \$3,000 / kW in 2015 based on an estimated three-fold increase in production (from 30 MW to 100 MW) during that timeframe. However, in 2014, the EPA estimates total installed cost for a 300 kW MCFC at \$10,000 / kW, a 400 kW PAFC at \$7,000 / kW, and a 1,400 kW MCFC at \$4,600 / kW.¹⁴ This suggests that costs have not come down as much as forecast by the DOE in 2011 (those forecasts were based on a tripling of production capacity; Fuel Cell Today suggests a doubling of capacity from 2011 to 2013).¹⁵

12 http://www.hydrogen.energy.gov/pdfs/11014_medium_scale_chp_target.pdf

13 http://cta.ornl.gov/cta/Publications/Reports/ORNL_TM2011_101_FINAL.pdf

14 EPA Catalog of CHP Technologies

15 http://www.fuelcelltoday.com/media/1889744/fct_review_2013.pdf



SGIP data from 2001 to present also show no substantial trends in cost reductions over time for these technologies. Due to these figures being estimated at the hundreds or thousands precision, no attempt was made to account for regional or dollar year cost impacts.

While costs have not come down much, the literature does suggest there are cost savings from increasing capacity, with units greater than 1 MW in the \$3,500 - \$4,500 per kW range and units less than 1 MW in the \$5,000 to \$10,000 per kW range. The SGIP data do not show strong evidence of cost savings due to scale, but many of the higher capacity projects are likely multiple installations of smaller units.

Given the uncertainty in the literature and SGIP self reported costs; we recommend the conservatively high value for the larger CHP category (1.2 MW) of \$4,500 per kW. For the 500 kW CHP category, we recommend \$7,500 per kW.

Current Technology Operating and Maintenance Costs

EPA and DOE/UC Berkeley suggest O&M costs to be \$0.03 - \$0.05 per kWh, including stack replacements every 5 years.¹⁶ We recommend \$0.04 / kWh for all capacities.

Total 2013 Cost Estimates

Table A-7 summarizes the cost data developed for fuel cells. Two CHP fuel cell size categories are considered (500 and 1,200 kW) and one electric-only fuel cell size category (500 kW). For CHP fuel cells, waste heat handling costs are embedded into system costs and are not shown separately.

¹⁶ <http://www.cesa.org/assets/Uploads/Stationary-FC-overview-9.28.2010-revised-Lipman.pdf>



TABLE A-7: FUEL CELL COST ESTIMATES

	Cost Data		
	CHP FC 500 kW	CHP FC 1,200 kW	Electric-only FC 500 kW
Electricity Generation System			
<i>Equipment</i>	3,750	2,250	3,750
<i>Labor</i>	2,625	1,575	2,625
<i>Balance of Plant</i>	1,125	675	1,125
<i>Additional Air Pollution Control</i>	-	-	-
<i>Other Costs</i>	-	-	-
System Cost per kW	7,500	4,500	7,500
Waste Heat Handling System (If Separate)			
<i>Equipment</i>	-	-	-
<i>Labor</i>	-	-	-
<i>Balance of Plant</i>	-	-	-
<i>Other Costs</i>	-	-	-
Waste Heat Handling Cost per Btu	-	-	-
Biogas Capital Costs			
<i>Gas Collection</i>	230	230	-
<i>Gas Clean Up</i>	807	563	-
<i>Other Costs</i>	-	-	-
Total Biogas Costs per kW	1,037	793	-
Total System Costs per kW*	8,537	5,293	7,500
O&M Costs			
<i>Electrical</i>	0.04	0.04	0.04
<i>Biogas Capture</i>	-	-	-
<i>Biogas Clean Up</i>	0.33	0.15	-
<i>Air Pollution Control</i>	-	-	-
Total O&M Costs per kWh*	0.37	0.19	0.04

* Total system cost per kW and total O&M costs per kW include costs associated with biogas collection and cleanup (see Appendix section A-1). These costs are not applied to projects that are fueled by natural gas or directed biogas. Furthermore, the increased cost of directed biogas procurement is handled elsewhere in the model.



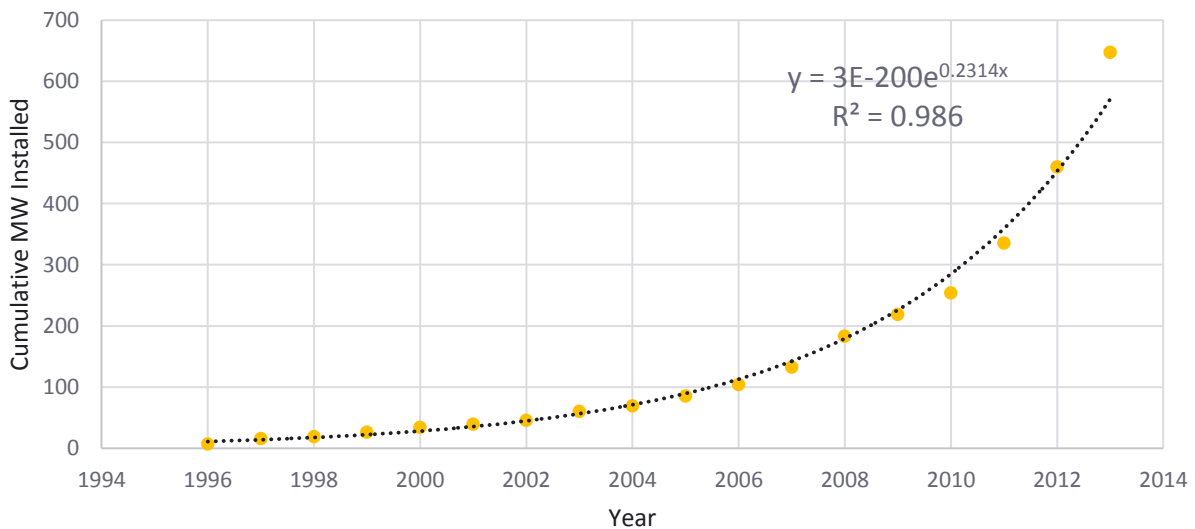
Estimating Future Capital Costs

In this section, we present the sources of data used when calculated learning curves and developing estimates of future costs. A single growth rate and progress ratio is assumed for all fuel cell technologies and size categories.

Technology Growth

Fuel cell growth is estimated based on historical global stationary fuel cells installed capacity figures. Figure A-5 shows the cumulative stationary fuel cell capacity installed over time and an exponential curve fit. Based on these, we estimate an exponential growth rate of 23%.

FIGURE A-5: FUEL CELL GROWTH RATE



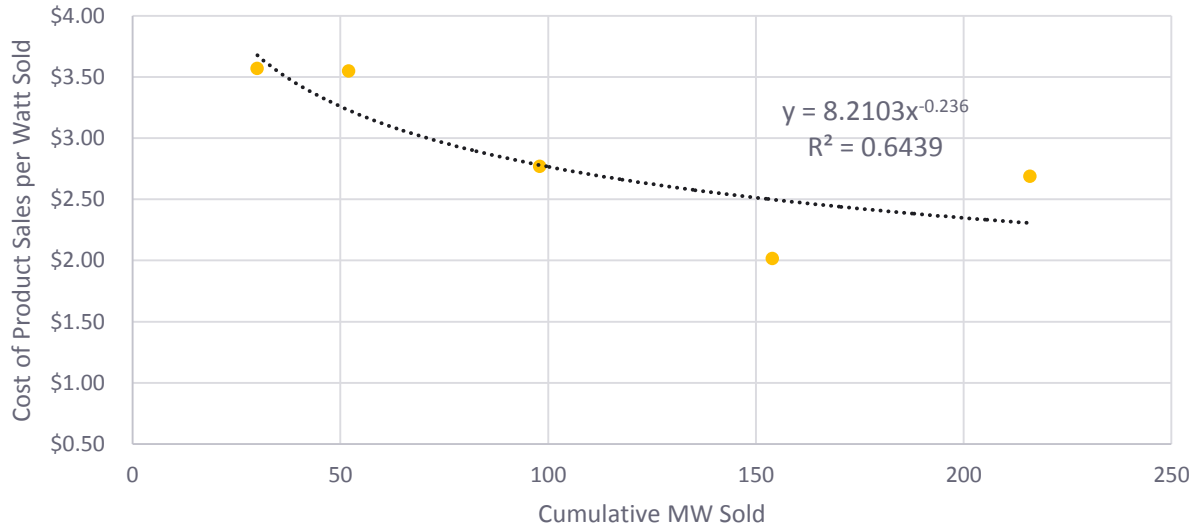
Source: Fuel Cell Today: The Fuel Cell Industry Review 2013 http://fuelcelltoday.com/media/1889744/fct_review_2013.pdf

Developing Learning Curves

Learning curves are determined from the relationship between cumulative sales and costs per Watt. For internal consistency, it is important that sales volumes and cost data be compiled using the same underlying assumptions. For this analysis, data from FuelCell Energy (a MCFC manufacturer) is used as a proxy for all fuel cells. Specifically, annual sales volumes and costs of product sales and revenues from FuelCell Energy’s annual reports are used to determine the progress ratio for MCFC manufacturing. This progress ratio is assumed to be applicable to all fuel cells. Figure A-6 shows FuelCell Energy’s costs of product sales per Watt sold as a function of cumulative capacity sold.



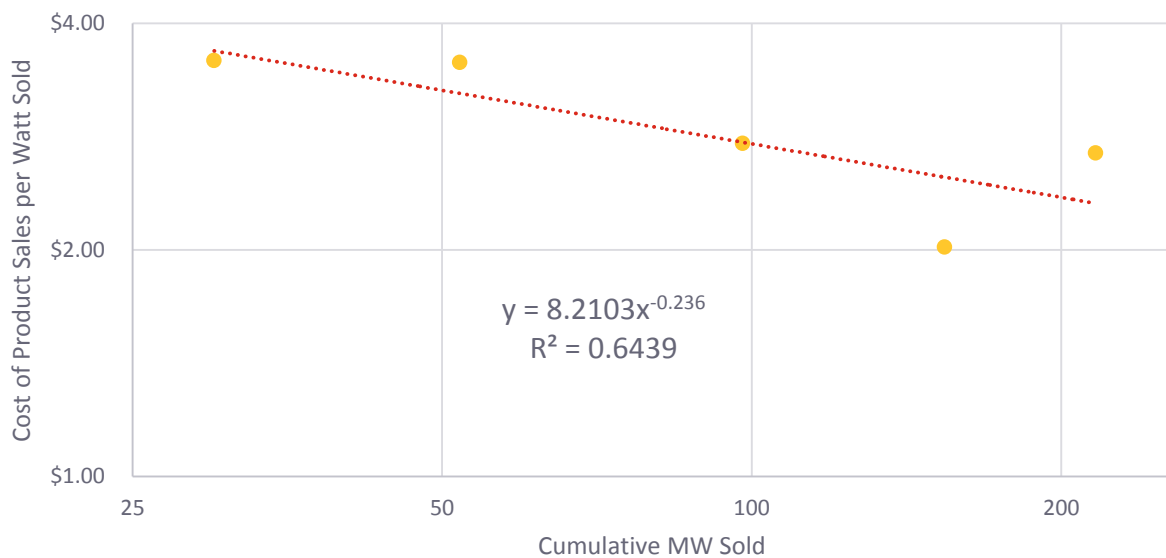
FIGURE A-6: FUEL CELL LEARNING CURVE



Source: FuelCell Energy Annual Statements <http://fcel.client.shareholder.com/annuals.cfm>

Based on the information in Figure A-5 and Figure A-6, we calculate a progress ratio of 85%. This estimate is in-line with an Oak Ridge National Lab report that suggests a range of progress ratios from 0.78 to 0.88.¹⁷ Figure A-7 shows the learning curve information on a log-log scale for comparison.

FIGURE A-7: LOG-LOG FUEL CELL LEARNING CURVE

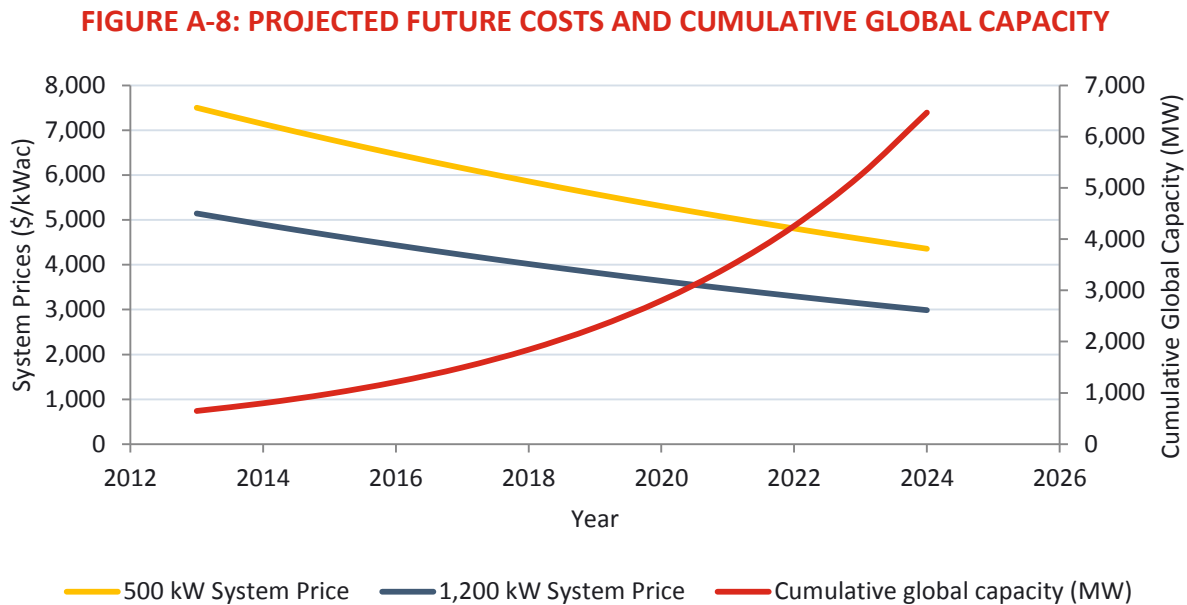


¹⁷ Status and Outlook for the U.S. Non-Automotive Fuel Cell Industry



Projected Future Costs

Figure A-8 summarizes the projected future costs and cumulative global capacity based on the growth rate and progress ratio defined above.



A.3 SMALL GAS TURBINES

This section provides a summary of the small gas turbine technology and describes the sources of capital and O&M cost estimates used in the cost effectiveness model. The discussion addresses two turbine size categories separately (2,500 kW and 7,000 kW). We further discuss the development of growth models and learning curves based on annual installed generation capacity, cumulative generation capacity, and historical cost data. We use the learning curve models to develop learning and progress ratios. We then use the growth models and learning ratios to project future installed costs.

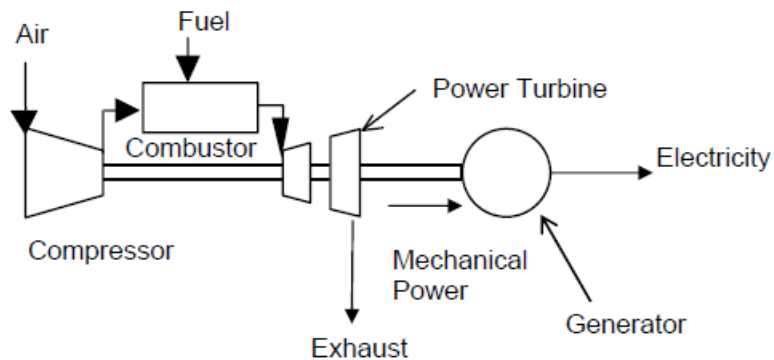
Technology Summary

Gas turbines are a mature technology that has been used for power generation and CHP applications for decades. They are favored because of their high efficiency, high reliability, and low emissions. Gas turbines account for 32% of central station power plant capacity and 63% of total installed CHP capacity.¹⁸ Gas turbines operate on the principle of the Brayton Cycle, a thermodynamic cycle where atmospheric air is compressed, heated, and expanded. Figure A-9 shows the basic configuration and components of a gas turbine system. The power is produced by the expansion of hot gases in the turbine which in turn provides mechanical power to rotate an electric generator. Gas turbines are high

¹⁸ EPA Catalog of CHP Technologies, 2014

temperature devices ideally suited for CHP applications because the exhaust heat produces high quality hot water or steam.¹⁹ For purposes of the cost effectiveness model, we assume the gas turbines are primarily fueled with natural gas and only consider use of biogas for the 2.5MW case in a landfill or waste water treatment facility.

FIGURE A-9: SCHEMATIC OF A GAS TURBINE SYSTEM²⁰



Gas turbine sizes can range anywhere from 500 kW to 250 MW systems. However, for the purposes of this cost effectiveness study, we evaluated two size categories of gas turbines: those less than 3 MW in capacity and those in the 3 to 7 MW size range. Within these size ranges, we use 2.5 MW and 7 MW as representative gas turbine capacities for modeling purposes. These smaller gas turbine systems operate in power-only generation or as CHP. In CHP applications the exhaust output produces steam or hot water. The steam or hot water is used in absorption chillers, or for additional power generation (i.e., through a bottoming cycle). Gas turbines run on natural gas, biogas, landfill gas, or fuel oils, and have a typical time to overhaul ranging from 25,000 to 50,000 hours. The major manufacturers include Kawasaki, GE, and Solar Turbines.

Technology Operating Characteristics

Gas turbines have a demonstrated history of being economical and reliable, especially for baseload and peak power configurations.

Typical Efficiencies

Gas turbines show electrical efficiencies ranging from 24% to 36% (HHV) depending on size. They have low part-load efficiency. Table A-8 shows reported electrical and total system efficiency for a nominal 7,000 kW system from two different sources.

19 http://www.understandingchp.com/AppGuide/Chapters/Chap4/4-3_Gas_Turbines.htm

20 US EPA, "Technology Characterization: Gas Turbines," Catalog of CHP Technologies (2014).

**TABLE A-8: GAS TURBINE ELECTRICAL EFFICIENCIES FOR TYPICAL 7,000 KW SYSTEMS**

Gas Turbine Technology	Electrical Conversion Efficiency (HHV)	Total System Efficiency (HHV)	Source
GT 7,000 kW – CHP	29%	70%	US EPA Catalog of CHP Technologies, 2014.
GT 7,000 kW – CHP	32%	65%	Self-Generation Incentive Program systems

Useful Waste Heat Recovery

For the purposes of this study, gas turbines were assumed to have the ability to recover 3,564 MBtu of useful waste heat per MWh of generated electricity. This information is based on data from metered projects in SGIP.

Criteria Air Pollution Emissions

Gas turbines are among the cleanest fossil-fueled power generation equipment available and with exhaust gas treatment or lean burn achieve very low emissions compared to IC engines or microturbines. However, turbine operating load has a significant effect on emissions level of NO_x, CO, and VOCs. Although maximum efficiency and optimum combustion is achieved at higher loads, NO_x emissions are also higher. Lower loads produce more incomplete combustion, resulting in higher emissions of CO and VOCs. Table A-9 shows average emissions levels for CO₂, NO_x and PM₁₀ for both 2.5 MW and 7 MW systems.

TABLE A-9: AVERAGE GAS TURBINE AIR POLLUTANT EMISSIONS RATES^{21:22:23}

Technology	CO ₂ lb/MWh	NO _x lb/MWh	PM ₁₀ lb/MWh
Gas turbine	1,199	0.070	0.05635

Generation Profiles and Ramp Rates

Gas turbines operate in peaking or baseload configurations. Figure A-10 illustrates a generation profile of an inland processing site such as a refining or food processing facility which fits with a baseload situation. Ramping of gas turbine operation is used for bringing the system up into power from a cold

²¹ US EPA, "Technology Characterization: Gas Turbines," Catalog of CHP Technologies (2014).

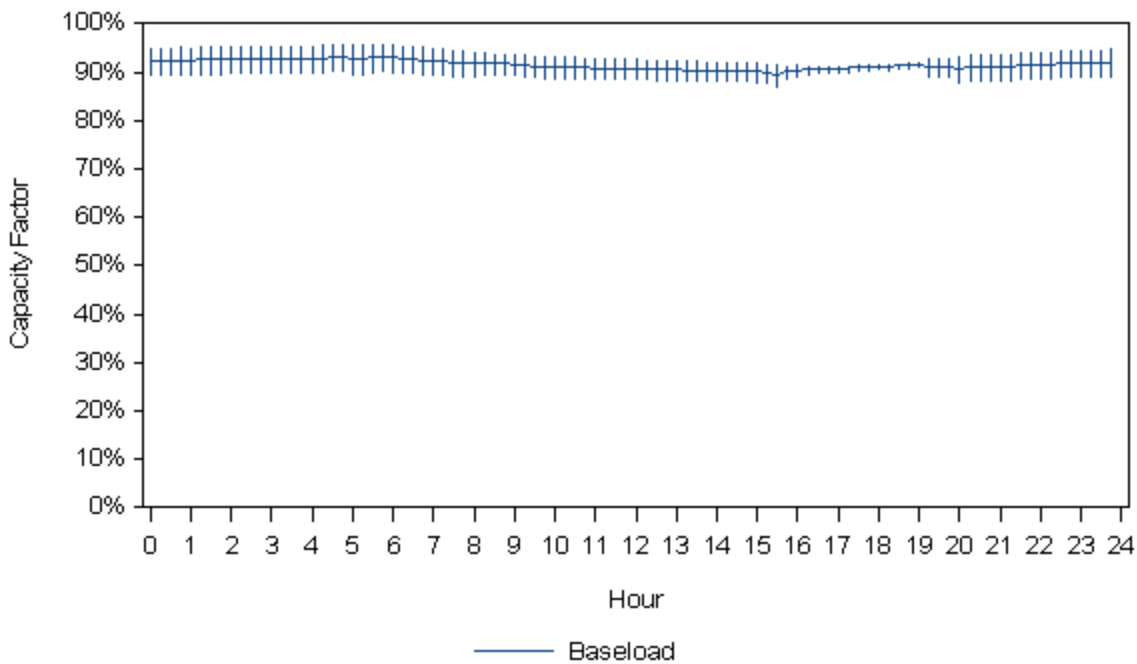
²² Distributed Energy Resources Emissions Survey and Technology Characterization, E2I, Palo Alto, CA, Ameren, St. Louis, MO, CEC, Sacramento, CA, New York Independent System Operator, Albany, NY, and New York Power Authority, White Plains, NY: 2004. 1011256

²³ Neil D. Strachan, and Alexander E. Farrell. 2004. "Emissions from Distributed Generation." Carnegie Mellon Electricity Industry Center, CEIC Working Paper 02-04. www.cmu.edu/ceic.



start or for reacting to some changes in demand. Gas turbines ramp up slowly from a cold condition to avoid temperature shocks. System efficiencies decrease substantially when gas turbines are operated at part-load. According to Solar Turbines, their gas turbines have an average ramp rate of 0.5% of nameplate power output per second.

FIGURE A-10: GAS TURBINE MEAN HOURLY CAPACITY FACTORS FOR INLAND TYPE PROCESS



Lifetime and Performance over Time

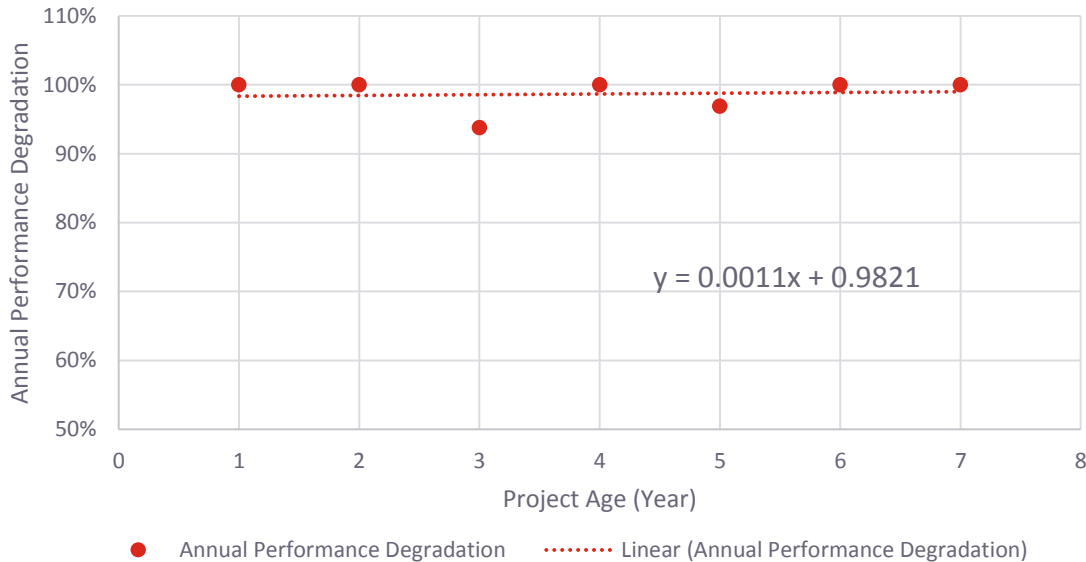
A typical gas turbine installation is expected to last 20 years. Figure A-11 illustrates performance degradation for metered SGIP systems; consequently, it is based on a small number of systems. The results show a near zero performance degradation, perhaps because of the limited number of metered sites. In addition, the projects are relatively new (i.e. less than five years old), and can be expected to show less degradation than older projects. Other sources, such as a report on Avoided Cost Estimates (Figure A-12) submitted to the Idaho Public Utilities Commission in 2002, reported annual degradation factor estimates of 1.75% for Gas Turbines,²⁴ while other studies have reported degradation factors of up to 2.5%²⁵ per year.

24 Jay K. Johnson, Idaho Public Utilities Commission, *Avoided Cost Estimate* (2002).

25 Rolf Kehlhofer, *Combined-Cycle Gas & Steam Turbine Power Plants* (Tulsa, Okla.: PennWell, 2009).

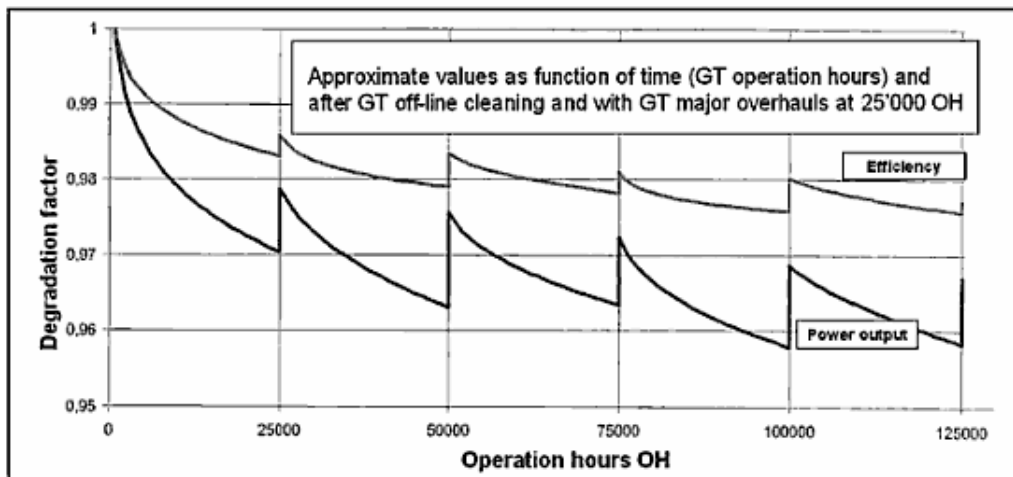


FIGURE A-11: GAS TURBINE DEGRADATION IN THE SGIP



Source: SGIP Performance Data

FIGURE A-12: DEGRADATION FACTOR VERSUS OPERATION HOURS



Source: Combined-Cycle Gas & Steam Turbine Power Plants (Tulsa, Okla.: PennWell, 2009)

Current Technology Capital Costs

Table A-10 summarizes the cost data developed for gas turbines in the 2.5 MW and 7 MW size ranges. The costs shown are for California installed systems with the required air emissions control equipment. The onsite biogas data show the additional costs associated with biogas collection and clean-up for the 2,500 kW gas turbine system. We do not include the cost of the anaerobic digester or cover in the cost effectiveness model. We assume these are sunk costs that would have been incurred whether or not the



gas turbine system was installed. We do include the gas piping costs because these are costs associated with installing and fueling the gas turbine system. The cost data are sourced from current literature^{26, 27, 28, 29} and manufacturers. Costs obtained for the same item are adjusted by taking the median data point. All costs are presented in 2013 dollars.

Current Technology Operating and Maintenance Costs

Maintenance for gas turbines includes “on-line running” maintenance, predictive maintenance, plotting trends, performance testing, fuel consumption, heat rate, vibration analysis, and preventive maintenance. Daily maintenance includes visual inspection of filters and site conditions. Routine inspections are required every 4,000 hours. Typical overhaul for these units requires 25,000-50,000 hours (up to 5.7 years of continuous operation), and includes complete inspection and rebuilding of components to restore the system to performance standards.

TABLE A-10: GAS TURBINE CAPITAL COST ESTIMATES

Average System Size (kW) / Gas Turbines	Cost Data		
	Natural Gas 2,500 kW	Onsite Biogas 2,500 kW	Natural Gas 7,000 kW
Electricity Generation System			
<i>Equipment</i>	1,766	1,766	1,710
<i>Labor</i>	596	596	559
<i>Balance of Plant</i>	-	-	-
<i>Additional Air Pollution Control</i>	-	-	-
<i>Other Costs</i>	570	570	515
System Cost per kW	2,933	2,933	2,784
Waste Heat Handling System (If Separate)			
<i>Equipment</i>	-	-	-
<i>Labor</i>	-	-	-
<i>Balance of Plant</i>	-	-	-
<i>Other Costs</i>	-	-	-
Waste Heat Handling Cost per Btu	-	-	-
Total Equipment Cost	2,933	2,933	2,784

26 US EPA, "Technology Characterization: Gas Turbines," Catalog of CHP Technologies (2014).

27 ICF International, Inc. - *CHP Policy Analysis and 2011-2030 Market Assessment Report*, Feb 2012 (for the CEC)

28 Study of Equipment Prices in the Power Sector. Dirk Pauschert. 2009.

29 Estimated Cost Of New Renewable and Fossil Generation in California. California Energy Commission 2014.



Average System Size (kW) / Gas Turbines	Cost Data		
	Natural Gas 2,500 kW	Onsite Biogas 2,500 kW	Natural Gas 7,000 kW
Biogas Capital Costs			
<i>Biogas Collection</i>	-	230	-
<i>Biogas Clean Up</i>	-	504	-
<i>Other biogas treatment costs</i>	-	-	-
Total Biogas Costs per kW	-	734	-
Total System Costs per kW*	2,933	3.667	2,784
O&M Costs			
Electrical	0.0127	0.0127	0.012
Biogas Capture	-	-	-
Biogas Clean Up	-	0.005	-
Air Pollution Control	-	-	-
Total O&M Costs per kWh*	0.0127	0.017	0.012

Estimating Future Capital Costs

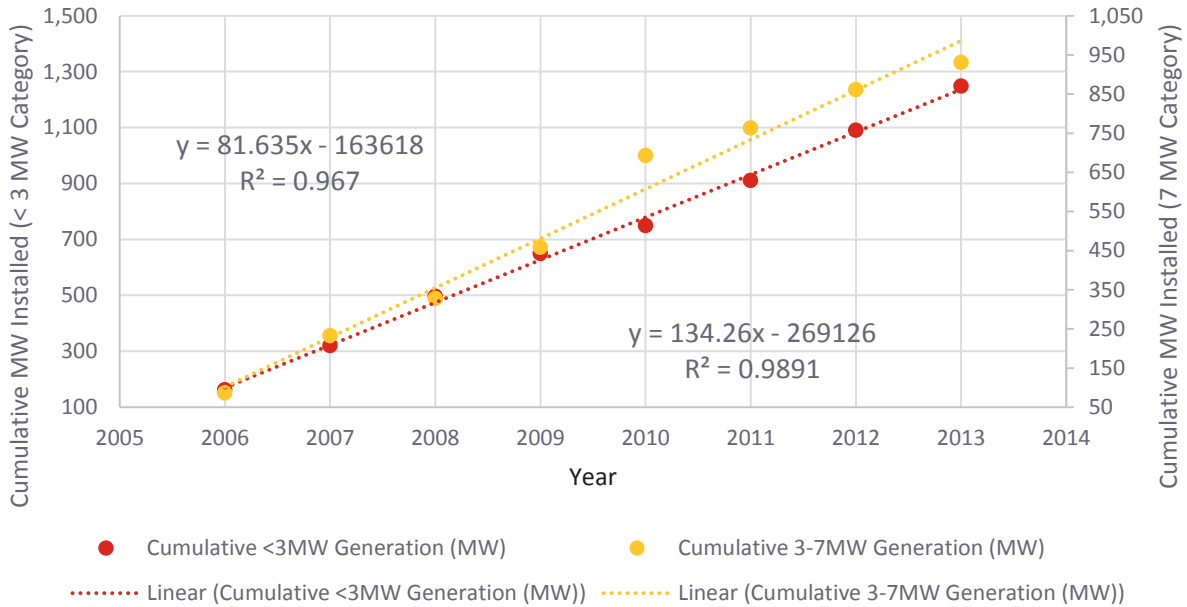
Future capital costs are based on the progress ratio obtained from technology learning curves and from historical growth rate data. In this section, we present what we used in the model, how we calculated learning curves and how this was applied to estimate future costs. Different progress ratios and growth rates are obtained for the two of turbine size categories.

Technology Growth

The volume of equipment being manufactured is obtained from the Diesel & Gas Turbine Worldwide Power Generation Order Surveys for the past eight years. For gas turbines, a linear growth model best fits the data because this is a mature technology with a tremendous market share. The linear model predicts an annual North America growth of approximately 82 MW and 134 MW of generation capacity for the less than 3 MW and 3-7 MW size categories respectively. We limit the data to North American sales to exclude diesel turbine sales.



FIGURE A-13: GAS TURBINE GROWTH RATE



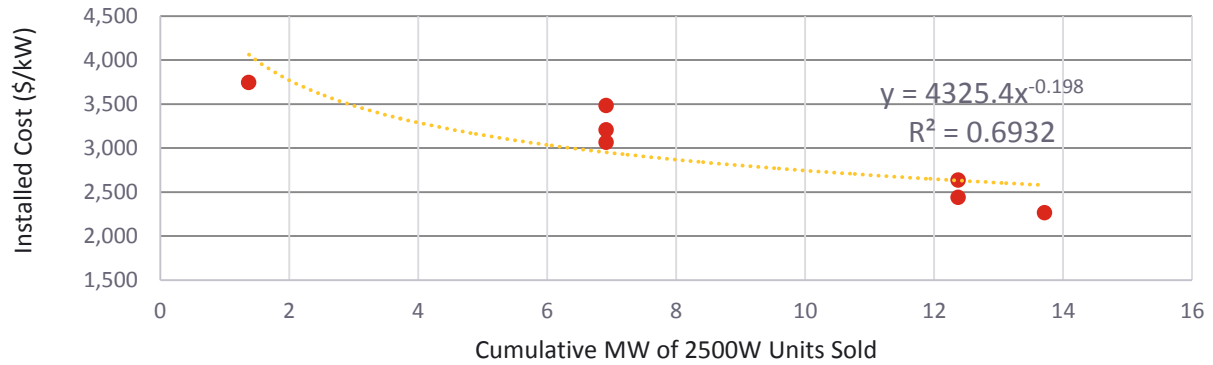
Source: Diesel & Gas Turbine Worldwide Surveys (2007-2014)

Developing Learning Curves

Learning curves provide a way of forecasting future costs based on a log relationship of historical installed cost and the cumulative capacity. Figure A-14 and Figure A-16 show the learning curves for the 2.5 MW and 7 MW gas turbine sizes and from these curves we estimate learning rates of 13% and 6% respectively.



FIGURE A-14: GAS TURBINE LEARNING CURVE (2.5 MW SYSTEMS)



Sources: Diesel & Gas Turbine Worldwide Surveys (2007-2014), US EPA Catalog of CHP Technologies Sep 2014, Commercial and Industrial CHP Technology Cost and Performance Data Analysis for EIA, June 2010, ICF International, Inc. Report - CHP Policy Analysis and 2011-2030 Market Assessment Report, Feb 2012 (for California Energy Commission)

FIGURE A-15: LOG-LOG LEARNING CURVE FOR 2.5 MW GAS TURBINES

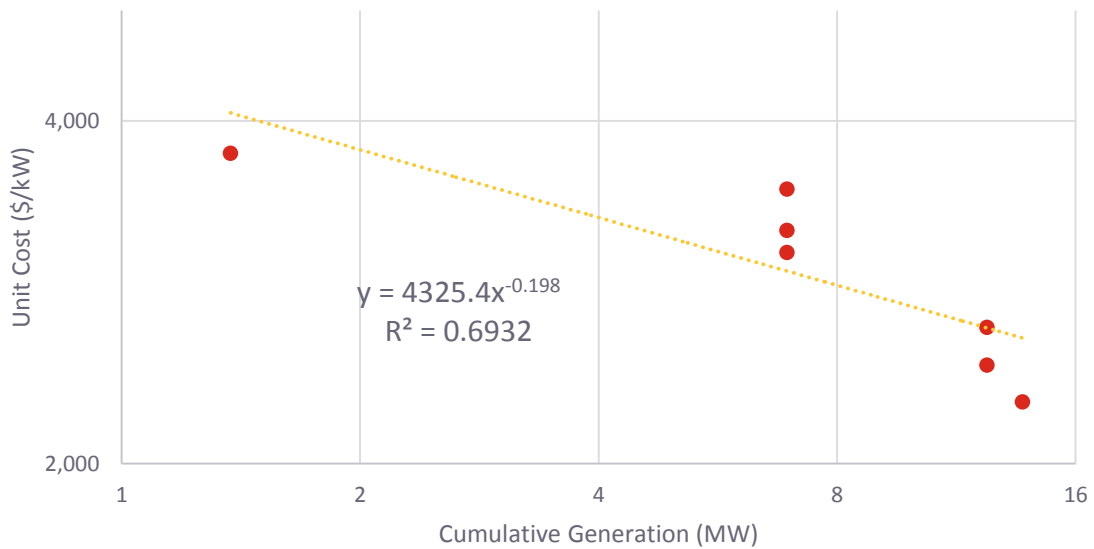
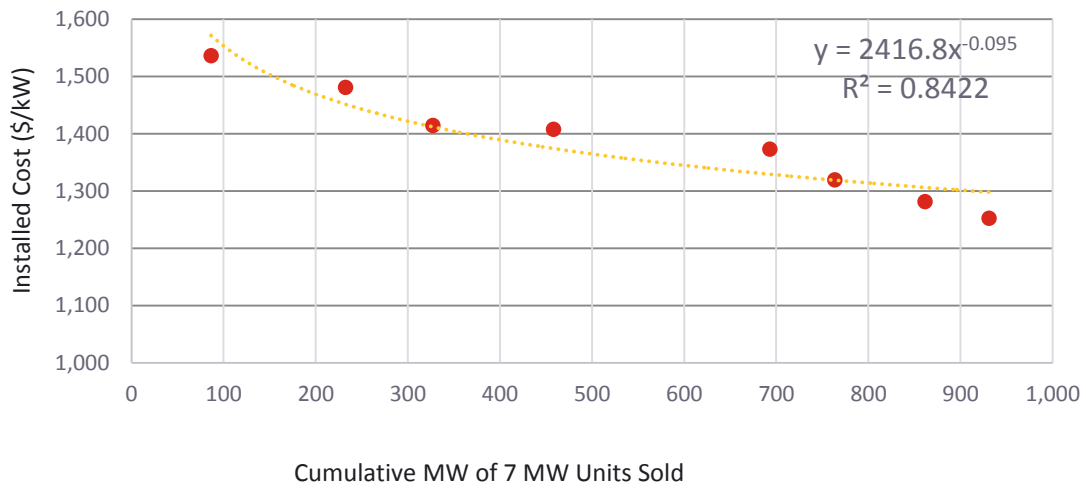


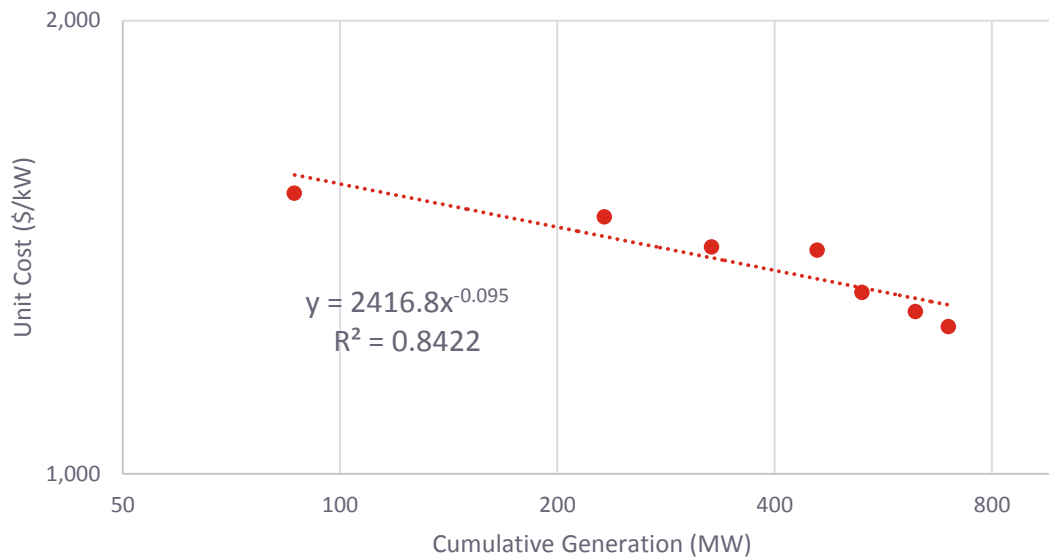


FIGURE A-16: GAS TURBINE LEARNING CURVE FOR 7 MW SYSTEMS



Sources: Diesel & Gas Turbine Worldwide Surveys (2007-2014), US EPA Catalog of CHP Technologies Sep 2014, Commercial and Industrial CHP Technology Cost and Performance Data Analysis for EIA, June 2010, ICF International, Inc. Report – CHP Policy Analysis and 2011-2030 Market Assessment Report, Feb 2012 (for the CEC)

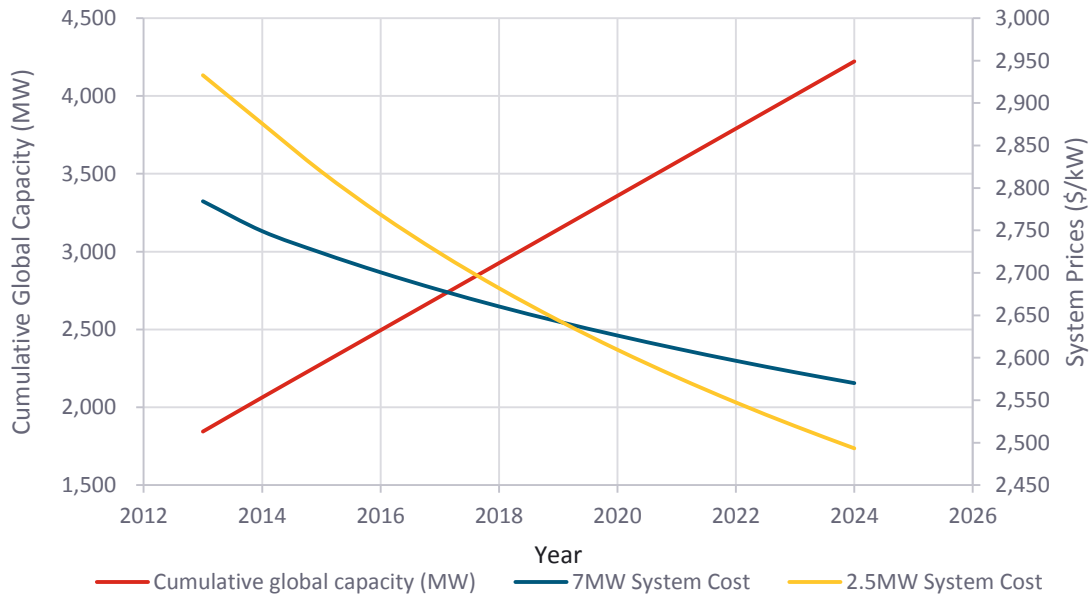
FIGURE A-17: LOG-LOG LEARNING CURVE FOR 7 MW GAS TURBINES



Projected Future Costs

Figure A-18 summarizes the projected future costs and cumulative global capacity based on the growth rate and progress ratios obtained above for the representative 2.5 MW and 7 MW gas turbine sizes. The relatively steep progress for the 2.5 MW gas turbine suggests there is a good opportunity to reduce costs through learning.

FIGURE A-18: PROJECTED FUTURE COSTS AND CUMULATIVE GLOBAL CAPACITY

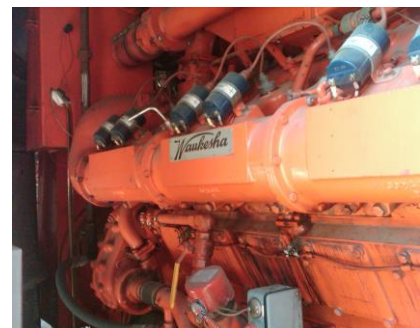


A.4 INTERNAL COMBUSTION ENGINES

This sub-section provides a summary of the IC engine technology and describes the sources of capital and O&M cost estimates used in the cost effectiveness model. The discussion addresses two representative engine sizes separately (500 kW and 1,500 kW). We further discuss the development of growth models and learning curves, annual installed generation capacity, cumulative generation capacity, and historical cost data. We use the learning curve models to develop learning and progress ratios. We then use the growth models and learning ratios to project future installed costs.

Technology Summary

IC engines are a very common source of generation technology across the world. IC engines are installed frequently because they are relatively economical, have high reliability, and have high availability. IC engines are also a proven technology that has been used for over a century in diverse applications. IC engines can be





classified into two broad categories (compression versus ignition) depending on how the fuel is ignited. Diesel engines are designed to operate when the compression of the fuel/air mixture gets hot enough to self-ignite. These compression ignition diesel engines tend to have high NOx emissions and, consequently, are used infrequently in California due to stringent NOx emission control requirements. Spark ignition engines require a spark to ignite the compressed fuel/air mixture. Spark ignition engines using natural gas or biogas are a common CHP technology used in California. The air/fuel mixture ignites in a control chamber designed to direct the expanding combustion gases to push a piston which rotates an attached crankshaft. The crankshaft transmits torque and shaft power that rotates a generator to produce electricity. IC engines range in capacity from 10 kW to 5 MW. The heat generated in the combustion process is typically recovered in a heat exchanger and used to produce hot water or low quality steam. This heat can then be used for such applications as space heating, in an absorption chiller, or to preheat boiler water. The major IC engine manufacturers include Tecogen, Caterpillar, MAN, GE Jenbacher, Deutz, and Waukesha.

Technology Operating Characteristics

IC engines have a demonstrated history of being relatively economical to install and of having short start-up times, high availability, and highly reliability. They are a common CHP technology. A major challenge for IC engine is control of air emissions (particularly NOx) so as to meet required standards. Most often IC engines control NOx emissions through the use of “post combustion” devices such as catalytic systems. These air pollution control systems represent increased system costs as well as O&M costs.

Typical Efficiencies

In general, IC engines show electrical efficiencies ranging from 27% to 36% (HHV) depending on engine size. IC engines demonstrate high part-load efficiency; with electrical efficiency ranging from 27% to 39% with a related load range of 30% to 100%. This means that an IC engine can match or follow the electric load demand within this window without a significant efficiency penalty. Typical observed efficiencies on IC engines deployed in the SGIP are 27% for electrical conversion (HHV) and 49% for total system efficiency (HHV).

TABLE A-11: REPRESENTATIVE IC ENGINE ELECTRICAL CONVERSION EFFICIENCIES

IC Engine Technology	Electrical Conversion Efficiency (HHV)	Total System Efficiency (HHV)	Source
IC Engine 500 kW – CHP	27%	80%	EPA Catalog of CHP Technologies, 2014.
IC Engine 1,500 kW – CHP	37%	78%	EPA Catalog of CHP Technologies, 2014

Useful Waste Heat Recovery

In IC engine CHP applications, waste heat is recovered from the exhaust gas, the engine cooling water jacket, and the lube oil system as illustrated in Figure A-19. The useful heat recovered can be used to preheat boiler water, provide onsite space heating or be used in absorption chiller applications to provide cooling depending on the application site's heat demand needs. Fuel use efficiency significantly improves when IC engines are used to produce hot water or low pressure steam. Thermal efficiency ranges from 35% to 48% with overall efficiency increasing to over 70%.

FIGURE A-19: COMBINED HEAT AND POWER SYSTEM OUTPUT³⁰

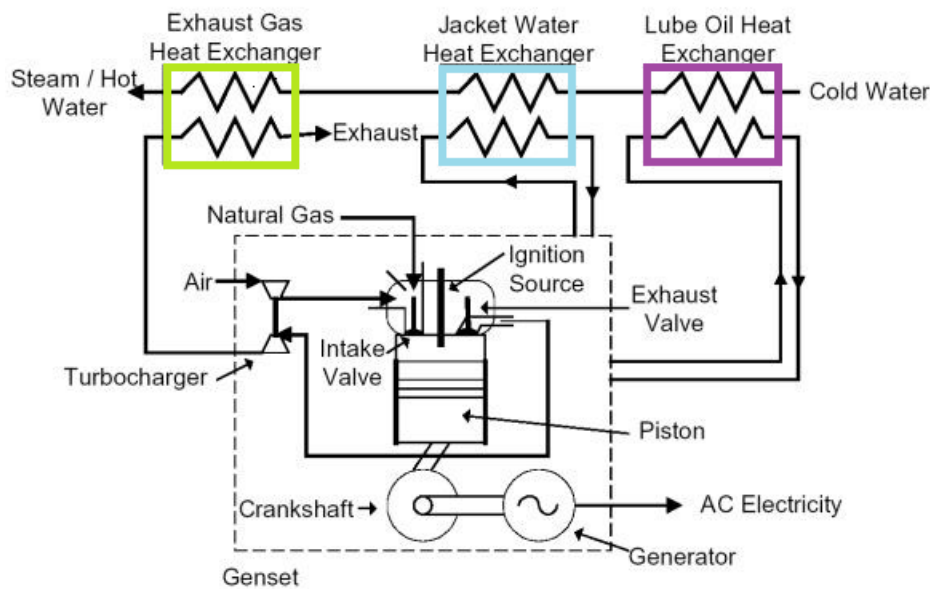


Table A-12 shows the range of useful heat recovery as reported by the Environmental Protection Agency (EPA)'s CHP Catalog. The large variance between the reported values shown in Table A-12 is due to the very site-specific nature of thermal demand. In addition, there can be variation in useful heat recovery depending on whether IC engine system is designed to be electrical load following or designed to match the site's thermal load. Sites designed to match thermal load tend to have a higher recovery rate.

TABLE A-12: IC ENGINE USEFUL HEAT RECOVERY RATE

IC Engine	Useful Heat Recovery Rate (MBTU/MWh)	Source
IC Engine (1,500kW)	4,385	http://www.epa.gov/chp/documents/catalog_chptech_full.pdf , 2014
IC Engine (1,500kW)	2,813	http://cpuc.ca.gov/puc/energy/distgen/sgip .

³⁰ http://www.energysolutionscenter.org/distgen/AppGuide/Chapters/Chap4/4-1_Recip_Engines.htm.



We use a slightly higher useful heat recovery rate of 4,630 MBtu/MWh in the SGIPce model. This useful heat recovery rate was selected to ensure IC engines meet the GHG emission target.

Criteria Air Pollution Emissions

Air pollution emission control is a major challenge to increased IC engine applications in California. The primary pollutants of concern are nitrogen oxides, carbon monoxide, volatile organic compounds and particulate matter. Sulfur oxides may be a pollutant when biogas is the fuel. IC engine emissions control strategies fall into one of two broad control categories: those used in rich-burn engines versus those used in lean-burn engines. The smaller engine sizes (i.e., less than 500kW) tend to be rich-burn and use a three-way catalyst (TWC) to control emissions of the three major pollutants (NO_x, CO and VOCs). The larger engines (1,500 kW) are available with lean-burn selective catalytic reduction (SCR) emissions control to control NO_x. In general, the TWC system increases operating and maintenance costs by 25%. Lean-burn engines equipped with SCR use consumable ammonia or urea, which adds to the O&M cost and makes it less cost effective for smaller IC engines. For lean-burn engines, additional oxidation catalysts are used to control the CO and VOCs. Typical criteria emission rates for IC engines are summarized in Table A-13.



TABLE A-13: AVERAGE IC ENGINES AIR POLLUTANT EMISSION RATES^{31:32:33}

Technology	CO ₂ lb/MWh	NO _x lb/MWh	PM ₁₀ lb/MWh
IC Engine –Non-Renewable fuel	1,066	0.070	0.06006
IC Engine –Renewable fuel	0	0.070	0.06969

Generation Profiles and Ramp Rates

IC engines operate in a baseload or load-following configuration, depending on site-specific needs and design. A major advantage of IC engines is the ability to be responsive and rapidly ramp up or down to meet electric load demand. Ramp rates range from 8 to 600 kW per minute. Ramp rates are important as they provide SGIP technologies the ability to load follow but also may play an important part in providing possible firming of intermittent generation sources (such as solar PV or wind) entering the

³¹ US EPA, "Technology Characterization: Gas Turbines," Catalog of CHP Technologies (2014)

³² Salas, William, Li, Changsheng, Mitloehner, Frank, and John Pisano. 2008. *Developing and Applying Process-Based Models for Estimating Greenhouse Gas and Air Emission from California Dairies*. CEC PIER Energy-Related Environmental Research. CEC-500-2008-093

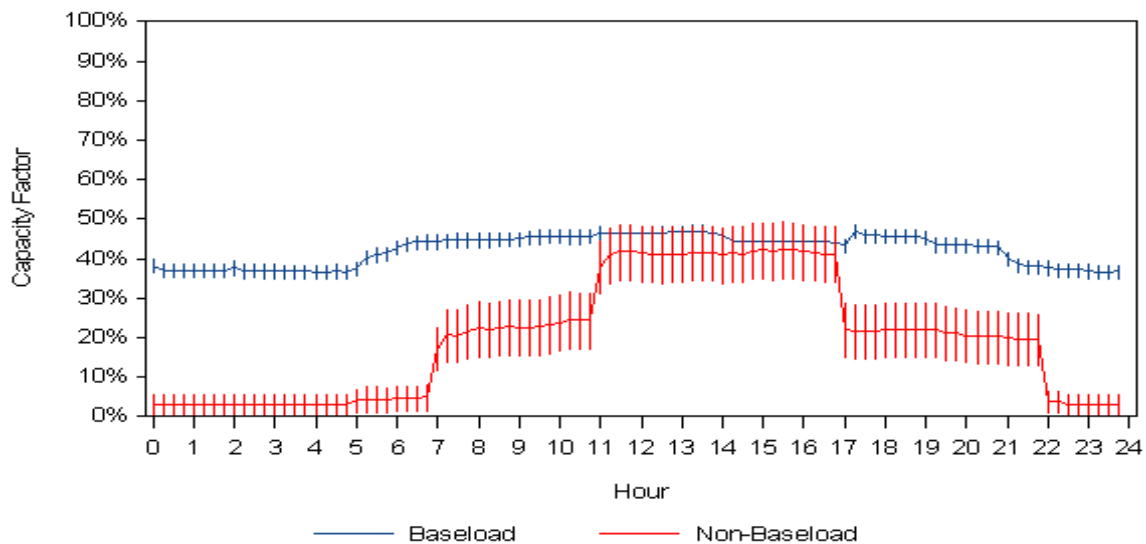
³³ San Joaquin Valley Last Update: 3/6/2013 Waste Gas-Fired IC Engine**Best Available Control Technology (BACT) Guideline 3.3.1



grid. At the same time, IC engines provide thermal energy that can help offset onsite boilers, thereby reducing fuel cost and lowering GHG emissions.

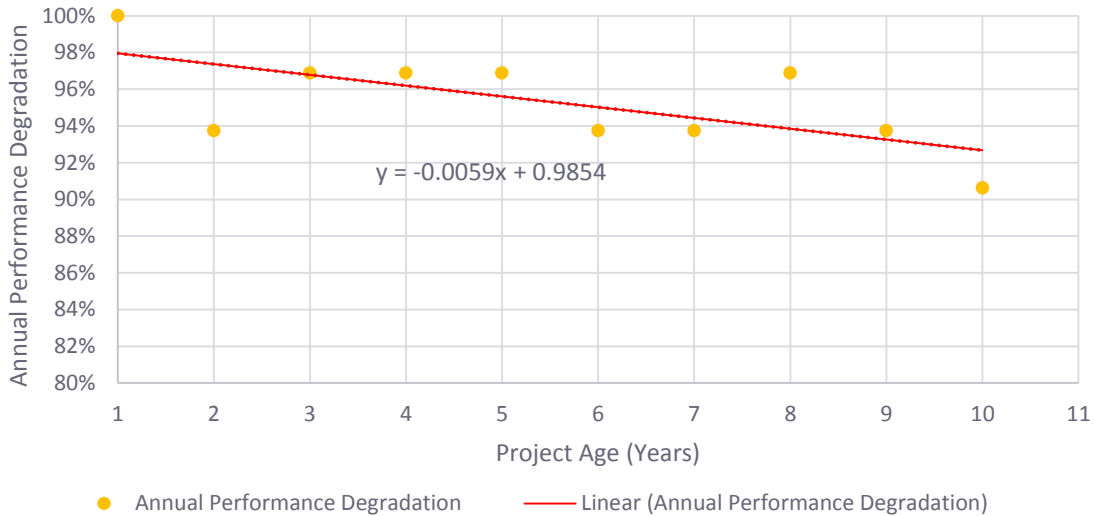
Figure A-20 illustrates a typical generation profile of an inland occupancy site such as an institutional building (universities, offices, and hotels) with an electric load and a thermal hot water requirement. The system responds to the coincident demand for electricity and hot water during the day/evening hours and ramps down during the off demand hours at night. The case illustrated in Figure A-20 also shows the potential for IC engines to providing firming electricity to the grid particularly if operated in a baseload scenario.

FIGURE A-20: MEAN HOURLY CAPACITY FACTORS FOR IC ENGINES USED IN INLAND TYPE OCCUPANCY APPLICATIONS



Lifetime and Performance over Time

A typical IC engine installation is expected to last 20 years. This assumes proper engine maintenance and rebuilding/replacement of certain components as directed in the manufacturers’ recommendations. Figure A-21 illustrates the performance degradation over time for SGIP systems with the trend being about 0.6% per year.

FIGURE A-21: IC ENGINE DEGRADATION IN THE SGIP


Source: SGIP Performance Data

Current Technology Capital Costs

Table A-14 summarizes the cost data developed for IC engines in the less than 500 kW and 1,500 kW size ranges respectively. The costs shown are for California installed systems with the required air emissions control equipment. The onsite biogas data show the additional costs associated with the biogas collection and biogas clean-up. For the biogas collection we do not include the cost of the digester or cover because we assume these are sunk costs that would have been incurred whether or not the CHP system was installed. We do include the gas piping costs because these are costs associated with installing and fueling the IC engine system. The cost data are sourced from current literature^{34,35,36} and expert field practitioners whom we contacted. Costs obtained for the same item are adjusted by taking the median data point. Generally, IC engine systems are packaged as a unit that includes the engine, generator, and waste heat recovery system. At installation, the waste heat recovery system is tailored to the use application and those costs are highly variable. All costs are presented in 2013 dollars.

Current Technology Operating and Maintenance Costs

Maintenance costs include routine replacement of engine oil and filters, engine coolant and spark plugs. For the on-site biogas case, maintenance cost includes biogas cleanup components. The O&M costs are obtained from current literature sources and from field experts who we contacted. Engine

34 US EPA Combined Heat and Power Partnership, Catalog of CHP Technologies Sep 2014

35 ICF International, Inc. Report - *CHP Policy Analysis and 2011-2030 Market Assessment Report*, Feb 2012 (for the CEC)

36 Commercial and Industrial CHP Technology Cost and Performance Data Analysis for EIA, June 2010



manufacturers recommend routine maintenance at 500-2,000 hours and a major overhaul at 30,000-72,000 hours of operation.

Table A-14 shows the O&M costs used for the two engine categories.

TABLE A-14: IC ENGINE COST ESTIMATES

Average System Size (kW) / IC Engines	Cost Data			
	Natural Gas 500 kW	Onsite Biogas 500 kW	Natural Gas 1500 kW	Onsite Biogas 1500 kW
Electricity Generation System				
<i>Equipment</i>	583	583	605	605
<i>Labor</i>	-	-	-	-
<i>Balance of Plant</i>	-	-	-	-
<i>Additional Air Pollution Control</i>	645	645	645	645
<i>Other Costs</i>	1,158	1,158	601	601
System Cost per kW	2,386	2,386	1,851	1,851
Waste Heat Handling System (If Separate)				
<i>Equipment</i>	-	-	-	-
<i>Labor</i>	-	-	-	-
<i>Balance of Plant</i>	-	-	-	-
<i>Other Costs</i>	167	167	167	167
Waste Heat Handling Cost per Btu	167	167	167	167
Total Equipment Cost	2,553	2,553	2,018	2,018
Biogas Capital Costs				
<i>Gas Collection</i>	-	230	-	230
<i>Gas Clean Up</i>	-	387	-	387
<i>Other Costs</i>	-	-	-	-
Total Biogas Costs per kW	-	617	-	617
Total System Costs per kW*	2,553	3,170	2,018	2,635
O&M Costs				
<i>Electrical</i>	0.023	0.023	0.018	0.018
<i>Biogas Capture</i>	-	-	-	-
<i>Biogas Clean Up</i>	-	0.046	-	0.034
<i>Air Pollution Control</i>	-	0.005	-	0.005
Total O&M Costs per kWh*	0.023	0.074	0.018	0.056



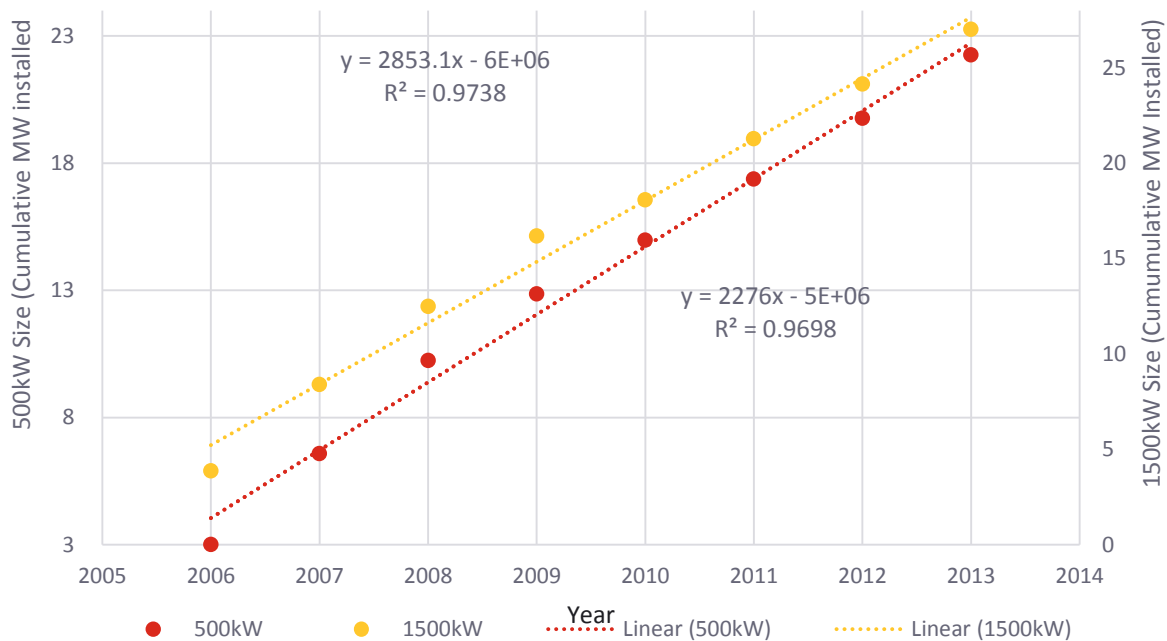
Estimating Future Capital Costs

Future capital costs are based on the progress ratio obtained from technology learning curves and from historical growth rate data. In this sub-section, we present what we used in the model, how we calculated learning curves, and how this was applied to estimate future costs. Different progress ratios and growth rates are obtained for the two of engine size categories.

Technology Growth

The volume of equipment being manufactured is obtained from the Diesel & Gas Turbine Worldwide Power Generation Order Surveys for the past eight years. We specifically use the subset data from North America. This data set reflects natural gas spark ignition engines representative of the spark ignition engines used in California. For IC engines, a linear growth model best fits the data because this is a mature technology and we expect a moderate amount of market growth. The linear model predicts an annual North America growth of about 2,300 MW and 2,900 MW of generation capacity for the 500kW and 1,500 kW engine categories respectively.

FIGURE A-22: IC ENGINE GROWTH RATE



Sources: Diesel & Gas Turbine Worldwide Surveys (2007-2014)

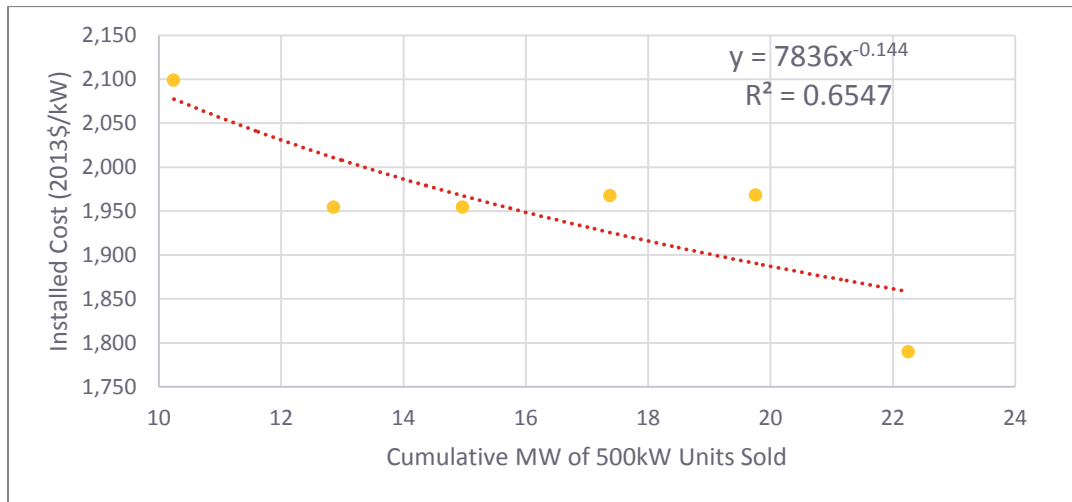
Developing Learning Curves

Figure A-23 and Figure A-25 show learning curves for the 500 kW and 1,500 kW size categories. Based on these curves we estimate learning ratios of 2% and 9% respectively. These low learning ratios



indicate that IC engine technology has well known manufacturing characteristics and there is limited potential for cost reductions due to learning. From Figure A-23 we derive a learning ratio of 9% from the log-log relationship of the installed cost and the cumulative generation capacity. This means that each time the cumulative capacity sold doubles we get a cost reduction of 9%. From Figure A-23 we note that at 10MW cumulative capacity, installed costs were \$2,100/kW. At 20MW cumulative capacity, we have installed costs of approximately \$1,900/kW. This is a 9% cost reduction when the cumulative capacity doubles.

FIGURE A-23: IC ENGINE LEARNING CURVE (500 KW)



Sources: Diesel & Gas Turbine Worldwide Surveys (2007-2014), US EPA Catalog of CHP Technologies Sep 2014, Commercial and Industrial CHP Technology Cost and Performance Data Analysis for EIA, June 2010, ICF International, Inc. Report - CHP Policy Analysis and 2011-2030 Market Assessment Report, Feb 2012 (for California Energy Commission)



FIGURE A-24: LOG-LOG IC ENGINE 500 KW LEARNING CURVE

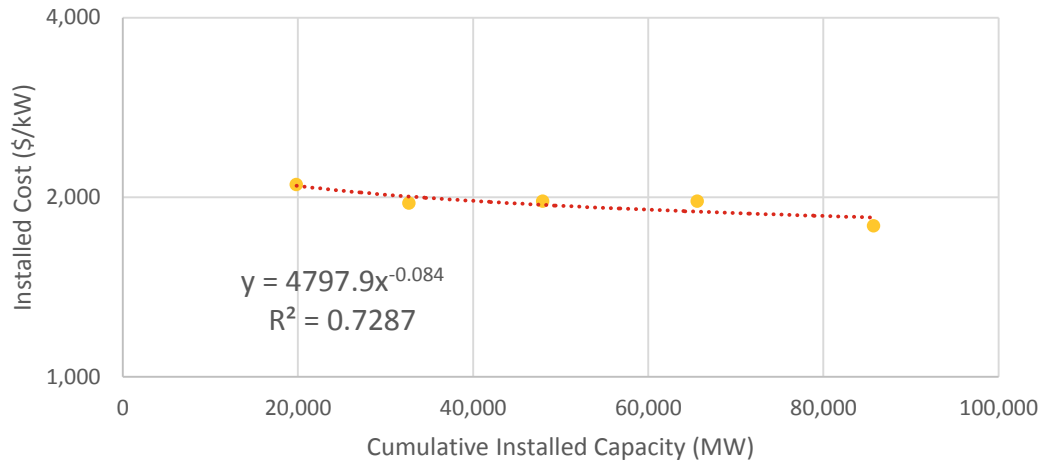
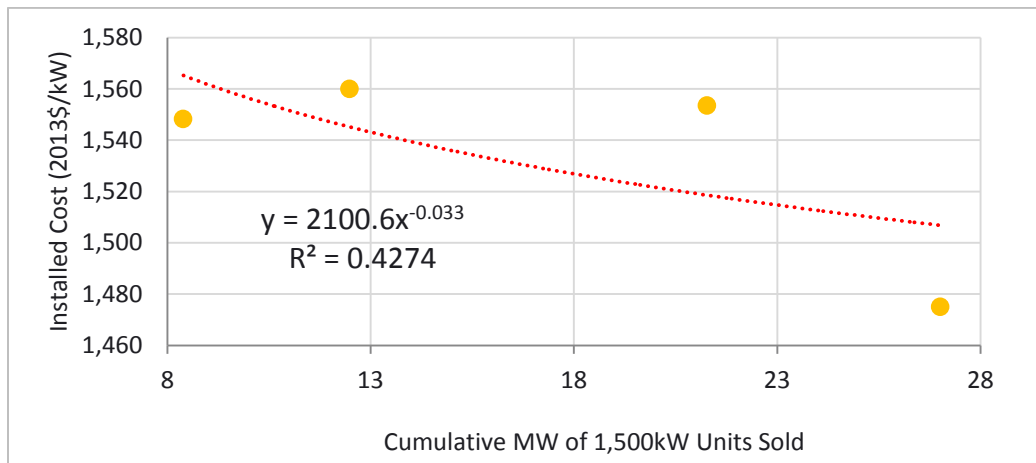


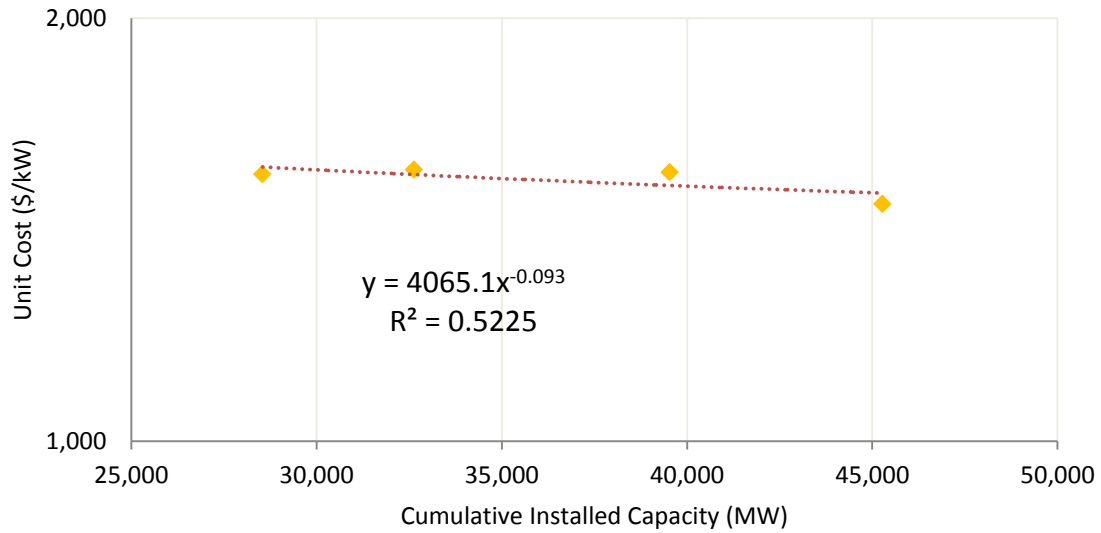
FIGURE A-25: IC ENGINE LEARNING CURVE (1,500 KW)



Sources: Diesel & Gas Turbine Worldwide Surveys (2007-2014), US EPA Catalog of CHP Technologies Sep 2014, Commercial and Industrial CHP Technology Cost and Performance Data Analysis for EIA, June 2010, ICF International, Inc. Report - CHP Policy Analysis and 2011-2030 Market Assessment Report, Feb 2012 (for California Energy Commission)



FIGURE A-26: LOG-LOG IC ENGINE 1500 KW LEARNING CURVE



Projected Future Costs

Coupling the learning ratio derived from the learning curve information with the growth model from the cumulative generation capacity data enables us to predict installed cost. The projected future cost curves for the 1,500 kW engine category is shown in Figure A-27. The 500 kW engine projected future cost is shown in Figure A-28.

FIGURE A-27: PROJECTED FUTURE COSTS AND CUMULATIVE CAPACITY (1,500 KW)

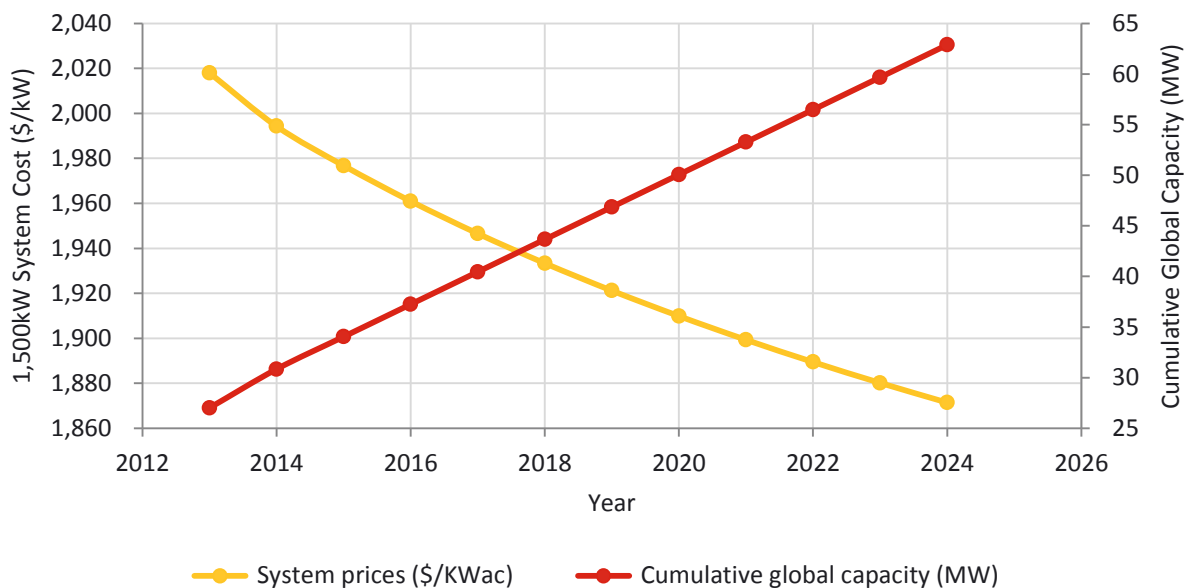
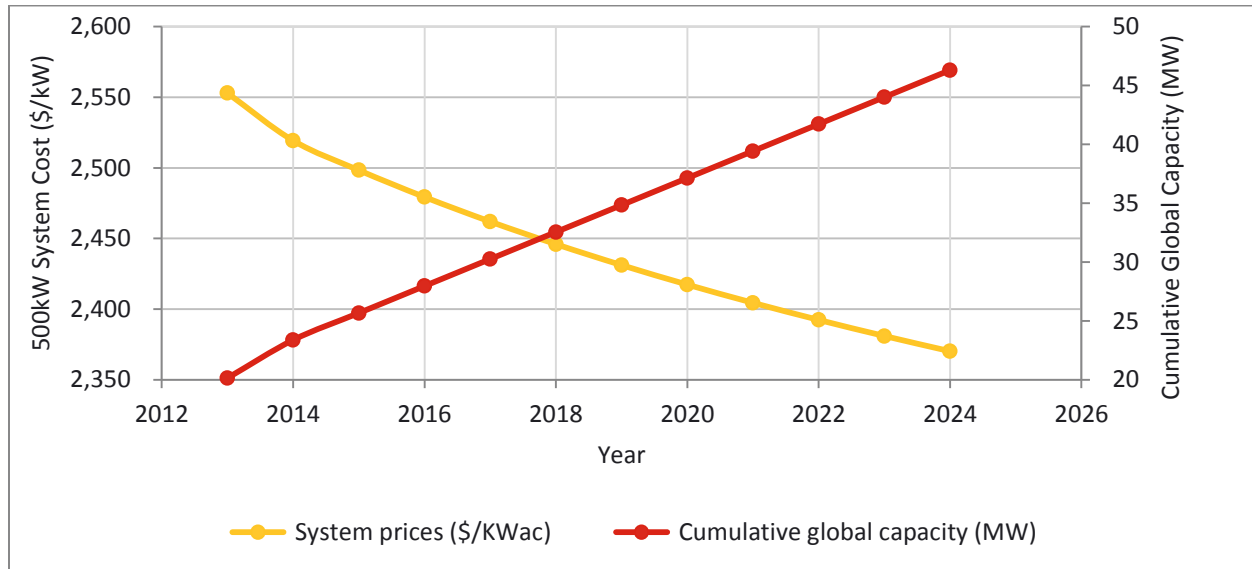


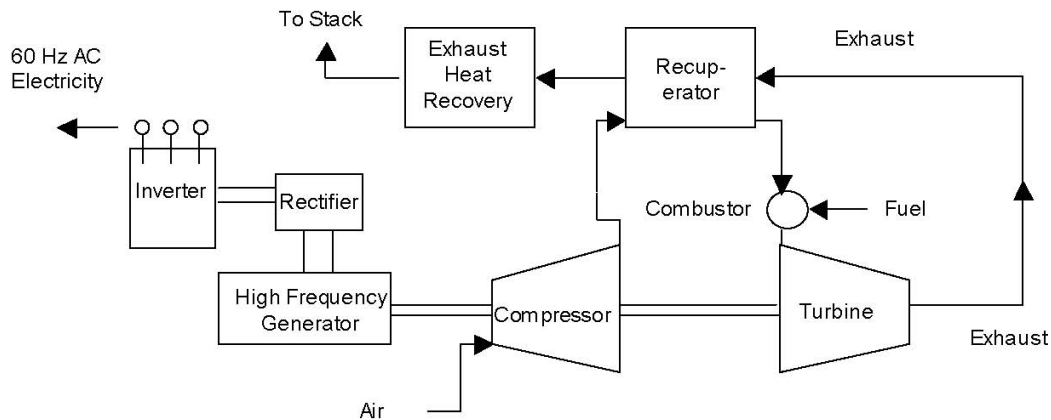
FIGURE A-28: PROJECTED FUTURE COSTS AND CUMULATIVE CAPACITY (<500 kW)


A.5 MICROTURBINES

This sub-section provides a microturbine technology summary and describes the sources of capital and O&M cost estimates used in the SGIPce model.

Technology Summary

Microturbines are small electricity generators that burn gaseous and liquid fuels to create high-speed rotation that turns an electrical generator. The size range for microturbines available and in development is from 30 to 250 kW. Many times, multiple units are installed onsite to reach higher electrical and thermal demands. Microturbine systems operate on the same thermodynamic cycle as larger gas turbines, known as the Brayton Cycle. They are able to run on a variety of fuels, including natural gas, sour gases (high sulfur, low Btu content), and liquid fuels such as gasoline, kerosene, and diesel fuel/distillate heating oil. In resource recovery applications, they burn waste gases that would otherwise be flared or released directly into the atmosphere. This can include landfills and coal mines where byproduct gases serve as essentially free fuel. Basic components of the microturbine system include the combustor, compressor, turbine, and recuperator (Heat Exchanger). Thermal output of these systems can range from 400-600°F, which is high enough to be used to heat building space, drive absorption chillers, produce hot water, or to supply other thermal needs in building or industrial processes. Figure A-29 below show a basic schematic of a microturbine CHP system and components.

FIGURE A-29: SIMPLE SCHEMATIC OF MICROTURBINE-BASED CHP SYSTEM³⁷


Capstone Turbine Corporation is a leader in production of microturbines and is headquartered in Los Angeles. Capstone represents about 70% to 80% of the total units sold in the world market annually. The majority of Capstone's units sold are their 65kW system, making it the most commonly sold microturbine unit on the market today. Capstone also has the highest prevalence of microturbine installations through the SGIP.

Technology Operating Characteristics

This section provides a description of the operating characteristics of microturbine technology.

Typical Efficiencies

Two common microturbine systems used in the U.S. marketplace are the Capstone C65 and the Ingersoll Rand MT 250. According to the manufacturer specification sheets the electrical efficiencies for the Capstone C65 and Ingersoll-Rand IR75 are rated at 29% and 30% (LHV), respectively. In contrast, measured data for microturbines installed in the past under the SGIP showed electrical efficiencies of approximately 23% (HHV) and 21% (LHV).

Many factors can affect the efficiencies of microturbine systems. Ambient temperatures have a noticeable effect on both the power output and efficiency of these units. Decreased air mass flow rates will result in a power decrease, while efficiency decreases because the compressor requires more power to compress air of higher temperature. The same effect goes for altitude changes. It takes more work for the microturbine to compress the higher-altitude, less dense air, reducing the efficiency of the units. Figure A-30 from Capstone shows how its C65 model performs with changes in ambient air temperature. For the purposes of this study, microturbines were assumed to have an electrical efficiency of approximately 21% (HHV), shown in Table A-15 below.

³⁷ Energy Nexus Group. "Technology Characterization: Microturbines." Catalog of CHP Technologies. 2008.



FIGURE A-30: C65 NET POWER & EFFICIENCY VS. AMBIENT TEMPERATURE AT SEA LEVEL³⁸

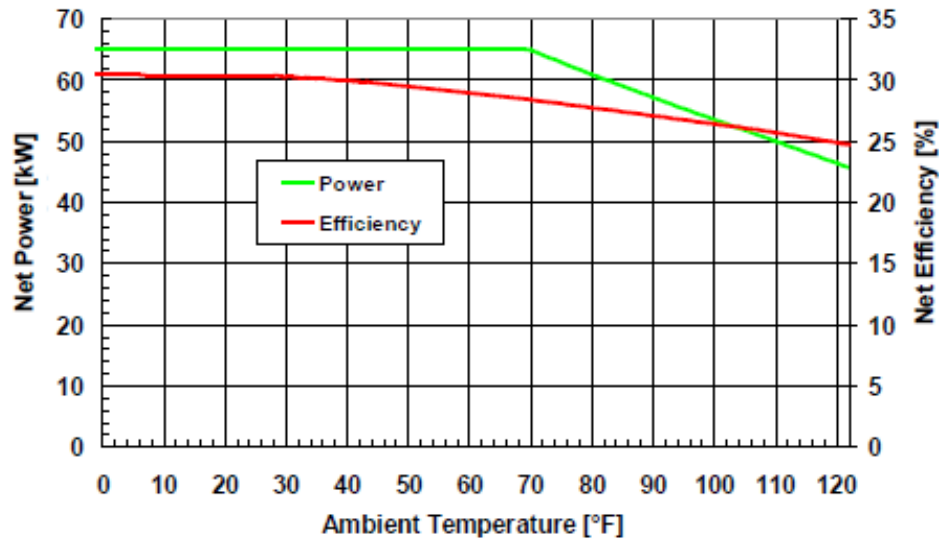


TABLE A-15: MICROTURBINE ELECTRICAL CONVERSION EFFICIENCY

Technology Type	Electrical Conversion Efficiency (HHV)	Source
Microturbine	21%	SGIP metered data

Useful Waste Heat Recovery

Like other CHP systems deployed under the SGIP, useful waste heat recovery was metered for microturbines. Using an average electrical efficiency for microturbines of approximately 21% and the CPUC requirement of at least 60% overall efficiency, microturbine systems were assumed to have the ability to recover 1,993 MBtu of useful waste heat per MWh of generated electricity, as seen in Table A-16 below.

TABLE A-16: MICROTURBINE USEFUL HEAT RECOVERY RATE

Technology Type	Useful Heat Recovery Rate (MBtu/MWh)	Source
Microturbine	1,993	SGIP metered data

Criteria Air Pollution Emissions

Low inlet temperatures and high fuel-to-air ratios result in low NOx emissions, while d higher electrical efficiencies result in lower CO₂ emissions. Typical criteria emission rate are summarized below in Table A-17.

³⁸ Capstone Turbines, Specification Sheet for C65 System.

**TABLE A-17: MICROTURBINE AIR POLLUTANT EMISSIONS RATES^{39,40}**

Technology	CO ₂ lb/MWh	NO _x lb/MWh	PM ₁₀ lb/MWh
Microturbine	1,828	0.070	0.086

Generation Profiles and Ramp Rates

Microturbines can be designed to meet the base load electric and thermal demand of host sites as well as designed to load follow the host site's changing electric and thermal demands. In addition, putting multiple units of microturbines together provides additional flexibility in meeting electrical and thermal energy demands. The Consortium for Electric Reliability Technology Solutions (CERTIS) has studied the behavior of microturbines during load changes. At higher load settings, step changes were accomplished at a rate of 1.2 to 3.6 seconds per kW whereas at lower load settings, step changes were accomplished at a rate of 4.4 to 7.6 seconds per kW. CERTIS concluded that for Capstone units, the transition time during power increase and decrease were much faster when the microturbine power output was above 10 kW.

Lifetime and Performance over Time

Interviews with microturbine manufacturers indicate that with scheduled overhaul and scheduled maintenance, microturbines should provide more than 100,000 hours of operation. As such, a 20 year lifetime is a conservative value for this technology. A degradation factor of 5% was determined from a 2012 Cadmus report on CHP inputs, data sources, and potential study results.⁴¹

Current Technology Capital Costs

The total capital costs for a 200 kW microturbine are broken down into equipment cost and installation costs. Basic equipment cost includes the cost of turbo generator package, heat recovery equipment, and gas booster compressor. The equipment costs are around \$2,152/kW, which represents 67% of the total project installation cost. The other costs include labor, material, piping, engineering and project management and are typically around \$1,052/kW; the remaining 33% of the overall project cost. Other costs are often referred to as *soft costs* because they vary widely with the installation and are site-specific. The microturbine equipment and other cost values used in the model were obtained from three literature sources from 2011 to 2014 and adjusted to 2013 dollars using the CPI inflation calculator.^{42,43,44} All sources provided total installed cost values; however, only the EPA report provided

³⁹ US EPA Combined Heat and Power Partnership, Catalog of CHP Technologies Sep 2014

⁴⁰ Capstone Applications. April 2008. Technical Reference Capstone MicroTurbine™ Systems Emissions.

⁴¹ http://www.pacificorp.com/content/dam/pacificorp/doc/Energy_Sources/Integrated_Resource_Plan/2013IRP/2013IRP_CHP-Memo-LCOEexcel_10-04-12.pdf

⁴² EPA - Catalog of CHP technologies, 201



equipment and other cost breakouts. The ratio of these breakout costs were applied to the ICF and NREL total installed costs to estimate their equipment and other costs values. The final total, equipment, and other cost values in the model come from the average of all the sources equivalent values. Table A-18 below summarizes the microturbine installed costs as well as O&M costs.

Current Technology Operating and Maintenance Costs

Microturbines require regular maintenance and the requirements will vary with fuel type, site conditions, and type of operation. Typical maintenance schedule for a Capstone microturbine includes the following:

- » Replace air and fuel filters after 8,000 hours
- » Inspect/replace fuel injectors, igniters, thermocouples after 16,000–20,000 hours
- » Replace battery (stand-alone units) after 20,000 hours
- » Major overhaul, core turbine replacement after 40,000 hours

The electrical O&M costs were broken out in the NREL onsite DG system study⁴⁵ and compared to its total installed cost. The ratio between these two values was then applied to the 2014 EPA Catalog of CHP Technologies total installed cost value⁴⁶ and ICF's 2012 CHP market assessment⁴⁷ total installed cost to estimate electrical O&M costs. The final electrical O&M cost estimate is based on the average of these three sources' values.

43 ICF - Combined Heat and Power Market Assessment, 2012

44 NREL - Onsite Distributed Generation Systems for laboratories, 2011

45 <http://www.nrel.gov/docs/fy11osti/50686.pdf>

46 http://www.epa.gov/chp/documents/catalog_chptech_full.pdf

47 <http://www.energy.ca.gov/2012publications/CEC-200-2012-002/CEC-200-2012-002-REV.pdf>



Total 2013 Cost Estimates

Table A-18 summarizes the cost data developed for 200 kW microturbines as discussed above.

TABLE A-18: COST ESTIMATES

	Cost Data
Average System Size (kW)	200
Electricity Generation System	
<i>Equipment</i>	2,152
<i>Labor</i>	-
<i>Balance of Plant</i>	-
<i>Additional Air Pollution Control</i>	-
<i>Other Costs</i>	1,052
System Cost per kW	3,204
Waste Heat Handling System (If Separate)	
<i>Equipment</i>	-
<i>labor</i>	-
<i>Balance of Plant</i>	-
<i>Other Costs</i>	-
Waste Heat Handling Cost per Btu	-
Total Equipment Cost	3,204
Biogas Capital Costs	
<i>Anaerobic Digester Gas Collection</i>	230
<i>Gas Clean Up</i>	744
<i>Other Costs</i>	-
Total Biogas Costs per kW	974
O&M Costs	
<i>Electrical</i>	0.026
<i>Biogas Capture</i>	-
<i>Biogas Clean Up</i>	0.008
<i>Air Pollution Control</i>	-
Total O&M Costs per kWh	0.0338



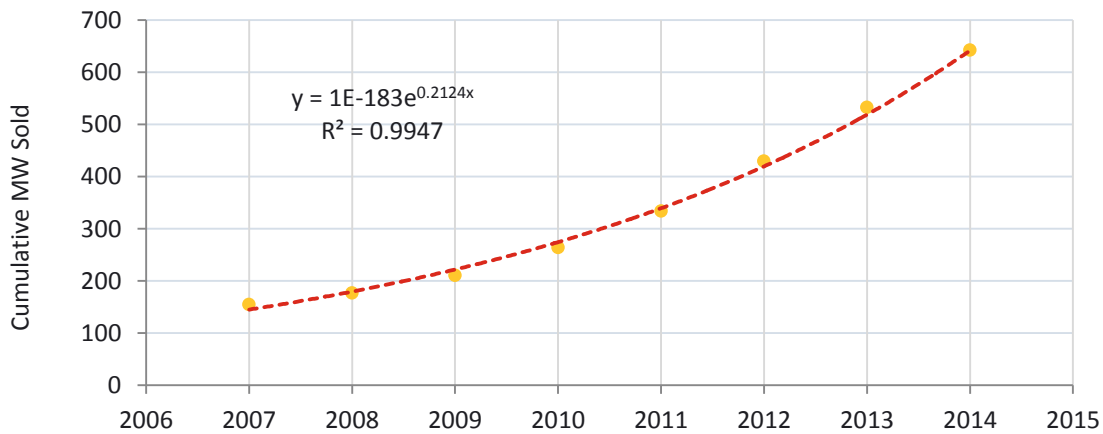
Estimating Future Capital Costs

In this sub-section, we present the sources of data used when calculating learning curves and developing estimates of future costs.

Technology Growth

Microturbine growth rate calculations are based on the generation orders as reported from Capstone Turbine Corporation's annual reports from 2007 to 2014. The exponential growth model fits the data best and is used to calculate future growth. Based on these, we estimate an exponential growth rate of 24%. Figure A-31 shows the yearly cumulative capacity sold and its exponential curve fit.

FIGURE A-31: MICROTURBINE GROWTH RATE



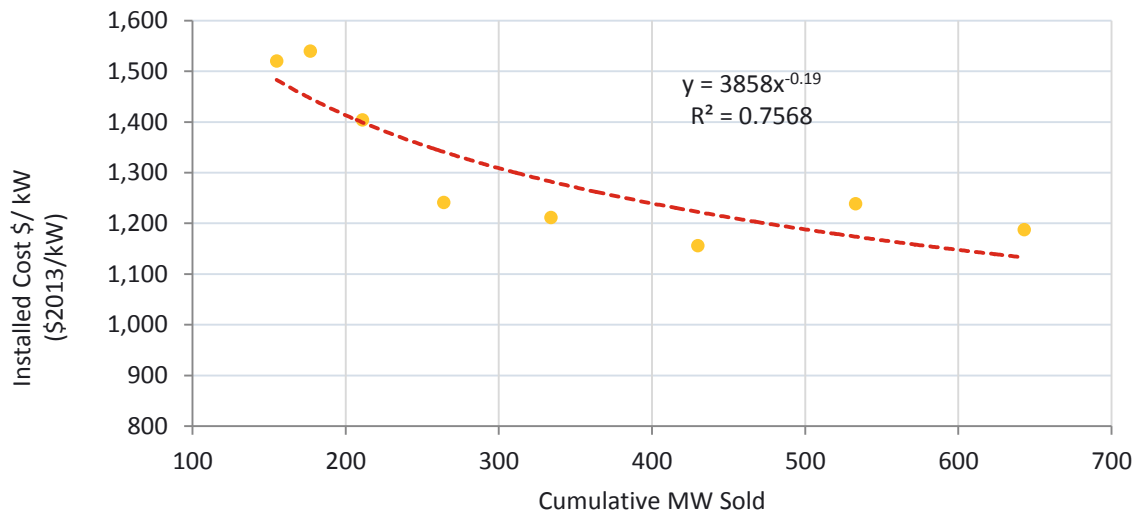
Source: Capstone Turbine Corporation Annual Reports

Developing Learning Curves

Learning curves are determined from the relationship between cumulative sales and costs per Watt. Both cumulative sales and cost data were based on generation orders as reported from Capstone Turbine Corporation's annual reports from 2007 to 2014. Based on these we estimate a progress ratio of 88%. Figure A-32 shows the installed cost/kW versus cumulative MW capacity sold and its power curve fit.

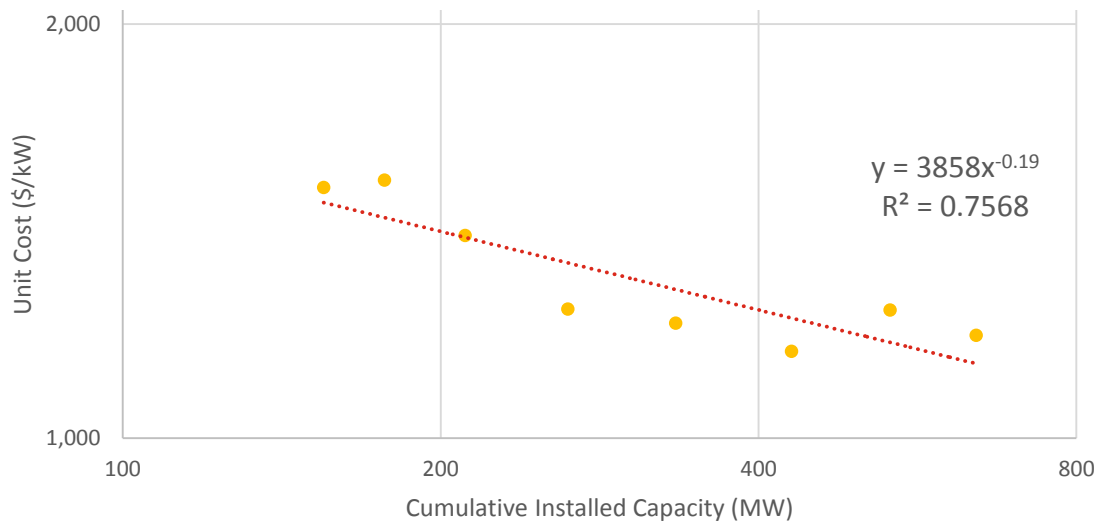


FIGURE A-32: MICROTURBINE LEARNING CURVE



Sources: Capstone Turbine Corporation annual reports, US EPA Catalog of CHP Technologies Sep 2014, ICF International, Inc. Report - CHP Policy Analysis and 2011-2030 Market Assessment Report, Feb 2012 (for California Energy Commission), NREL_Onsite_Distributed_Generation_Systems_For_Laboaratories_2011

FIGURE A-33: LOG-LOG MT 200 KW LEARNING CURVE

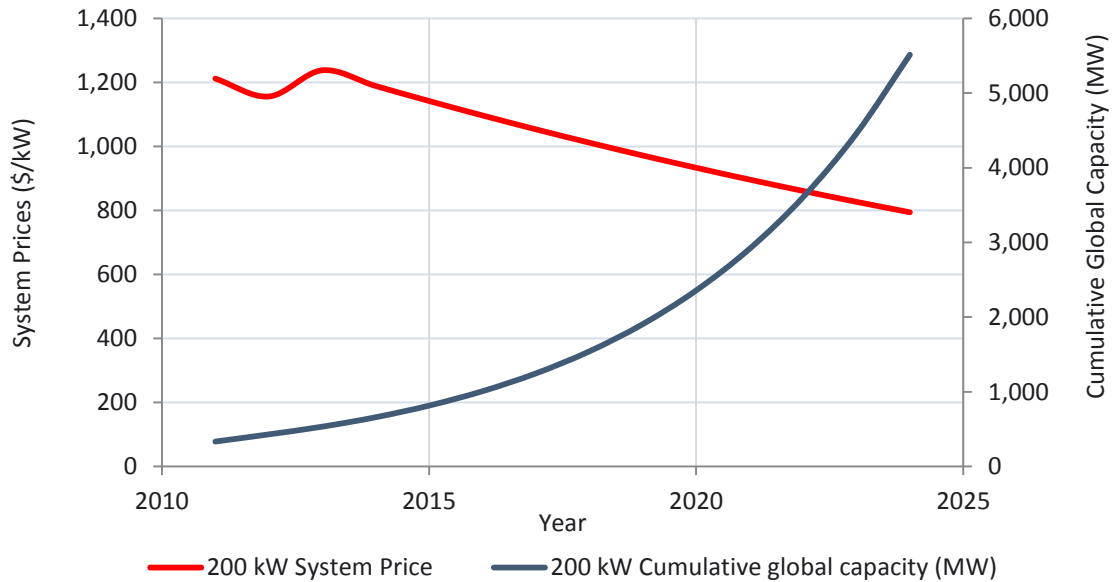


Projected Future Costs

Figure A-34 summarizes the projected future costs and cumulative global capacity based on the growth rate and progress ratio defined above.



FIGURE A-34: PROJECTED FUTURE COSTS AND CUMULATIVE GLOBAL CAPACITY



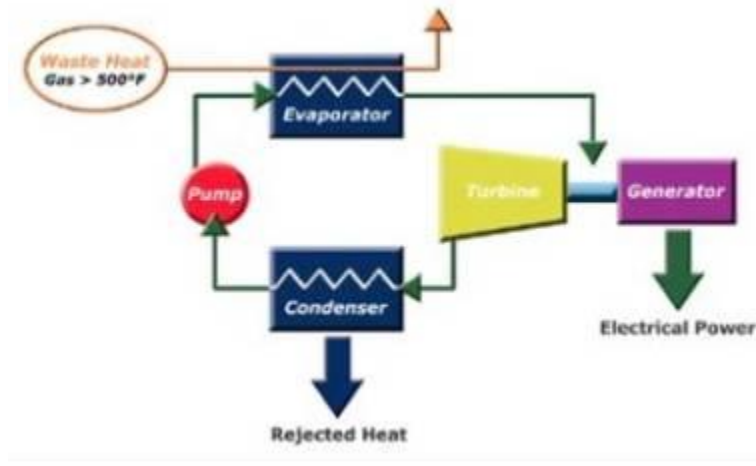
A.6 ORGANIC RANKINE CYCLES

This sub-section provides a summary of Organic Rankine Cycle technology and describes the sources of capital and O&M cost estimates used in the SGIPce model.

Technology Summary

Organic Rankine Cycle (ORC) refers to a waste heat recovery system which uses an organic, low boiling point working fluid to generate electricity through a Rankine cycle. The most common Rankine Cycle engine uses steam. A Rankine cycle typically consists of four parts: a pump, an evaporator, an expander and a condenser.

Figure A-35 illustrates a simple Rankine cycle system.

FIGURE A-35: SIMPLIFIED RANKINE CYCLE⁴⁸


In an ORC system, the working fluid is boiled in the evaporator to a vapor phase. The vapor expands, rotating a turbine that is then used to drive a generator. The exhaust vapors from the turbine are cooled into a liquid in the condenser. A pump is used to recirculate the working fluid from the condenser to the evaporator for the process to start again. Heat is absorbed in the system at the evaporator and removed from the system at the condenser.

ORC system working fluid characteristics are determined by the heat source temperatures. ORC systems typically use organic materials such as silicone oil and pentane as the working fluid. These compounds have low boiling points that can match the available heat. Waste heat suitable for ORC power plants can come from gas turbines and reciprocating engines. Temperatures of waste heat available ranges from 370-540°C and 230-600°C for gas turbines and reciprocating engines, respectively.

ORC requires little maintenance and its operations can be automated. It has good part load performance. The efficiency of ORC is estimated at 10-20% and is dependent on the temperature difference between the evaporator and condenser. A greater temperature difference results in a higher efficiency. Benefits from ORC systems include the following:

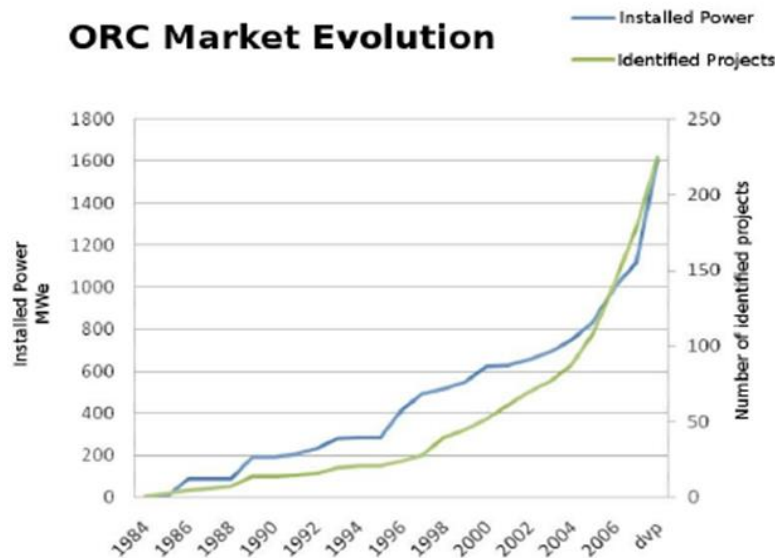
- » The ORC organic fluid has a lower freezing point than water, allowing the condenser to transfer heat at a lower temperature, increasing cold weather performance.
- » ORC condensers are typically air-cooled, enhancing their use in remote locations and eliminating disposal issues for cooling-water treatment chemicals.
- » Organic working fluid condensing pressure is above atmospheric pressure, so no complex vacuum systems needed.
- » ORC systems do not require 24/7 monitoring, and can be used in unmanned applications.

48 http://www.stowa-lectedtechnologies.nl/Sheets/Sheets/ORC%200706_files/image002.jpg



Figure A-36 shows that the installed power from ORC engines has increased exponentially worldwide over the past three decades. The figure below is intended to show the long-term trend of ORC installed capacity as more recent global capacity information was not available. Typical ORC capacities fall into two size categories: 100kW and 1MW. However, due to limited data surrounding ORC cost/kW, growth rates, and performance, the information discussed below will apply to both 100kW, 1MW, and any system in-between.

FIGURE A-36: ORC MARKET EVOLUTION⁴⁹



Technology Operating Characteristics

The following section describes technical aspects of the ORC, including electrical efficiencies and emissions.

Typical Efficiencies

Electrical efficiency of these cycles can range from 20% to 24%, 20% for CHP applications and 24% for non-CHP applications.⁵⁰ Because ORC systems do not require high temperature differences, waste heat is a good source of heat input for ORC systems. Low grade waste heat can be found in many industrial processes and from the waste heat discharged from IC engines. For the purposes of this cost effectiveness study, we assumed ORC systems with an electrical efficiency of 22%.

49 http://www.labohtap.ulg.ac.be/cmsms/uploads/File/ECEMEI_PaperULg_SQLV090407.pdf

50 <http://www.turboden.eu/en/rankine/rankine-theory.php>



Useful Waste Heat Recovery

Waste heat in the hot exhaust of a gas turbine or reciprocating IC engine can be recovered through an ORC system. These systems will generally have a heat rate of approximately 7,000 Btu/kWh.

Criteria Air Pollution Emissions

As ORC systems are closed-loop cycles and use waste heat, there is no fuel input. Consequently, ORC systems have no air pollution emissions.

Generation Profiles and Ramp Rates

Ramp rate for an ORC system is dependent on the source providing the waste heat. If a turbine was to be started from a cold condition without any warm up, the temperature strains set in the casing and rotors by a rapid heating will cause harm. Consequently, these units need to be slowly warmed up in accordance with recommended ramp rates. According to Freepower, it takes about 40 minutes for their 120 kW system to reach full power from a cold start. This translates to a ramp rate of 2.5% of rated capacity per minute.

Lifetime and Performance over Time

The estimated lifetime for ORC used in the model is 15 years.⁵¹

Current Technology Capital Costs

Total installed cost values were generated from two sources (Lehigh University Analysis of Low Temperature ORC Cycles for Solar Applications and an interview with the president of a waste heat power consulting company) and normalized to 2013 dollars using the CPI index. Values for equipment and labor costs were broken out from interviewee's total cost values and used to generate equipment and labor breakout ratios. These ratios were applied to the total cost given in the Lehigh University study to estimate their equipment and labor cost breakouts. The final total, equipment, and labor costs values come from the average of these sources' values. Table A-19 summarizes the cost data developed for 500 kW ORC technology.

Current Technology Operating and Maintenance Costs

The electrical O&M costs came directly from the Lehigh University paper and feedback from the industry expert interview. All values were in acceptable ranges and were averaged together to generate a final O&M cost estimate.

⁵¹ <http://www.wseas.us/e-library/conferences/2005athens/eesd/papers/505-122.pdf>



Total 2013 Cost Estimates

Table A-19 summarizes the cost data developed for a 500 kW ORC, as discussed above.

TABLE A-19: ORC COST ESTIMATES

	Cost Data
Average System Size (kW)	500
Electricity Generation System	
<i>Equipment</i>	2,542
<i>Labor</i>	1,058
<i>Balance of Plant</i>	-
<i>Additional Air Pollution Control</i>	-
<i>Other Costs</i>	-
System Cost per kW	3,600
Waste Heat Handling System (If Separate)	
<i>Equipment</i>	-
<i>Labor</i>	-
<i>Balance of Plant</i>	-
<i>Other Costs</i>	-
Waste Heat Handling Cost per Btu	-
	-
Biogas Capital Costs	
<i>Anaerobic Digester Gas Collection</i>	-
<i>Gas Clean Up</i>	-
<i>Other Costs</i>	-
Total Biogas Costs per kW	-
O&M Costs	
<i>Electrical</i>	0.994
<i>Biogas Capture</i>	-
<i>Biogas Clean Up</i>	-
<i>Air Pollution Control</i>	-
Total O&M Costs per kWh	0.994

Estimating Future Capital Costs

This section is intended to present the sources of data used when calculating growth rates and progress ratios to develop technology learning curves. A literature review was conducted to find ORC cost/kWh and installed or sold capacity over time. However no studies or public documents were found to contain this information. As such, phone calls and emails were made to industry manufacturers and developers



of ORC for cost/kW and installed or sold capacity over time. No manufacturers or developers were willing or able to provide such information. As such, a flat learning curve and growth rate will be used for ORC technology in the cost effectiveness model as no data are available to show otherwise.

Technology Growth

A growth rate of 0% will be used for estimating future installed capacity as no supporting data are available to generate other growth trends.

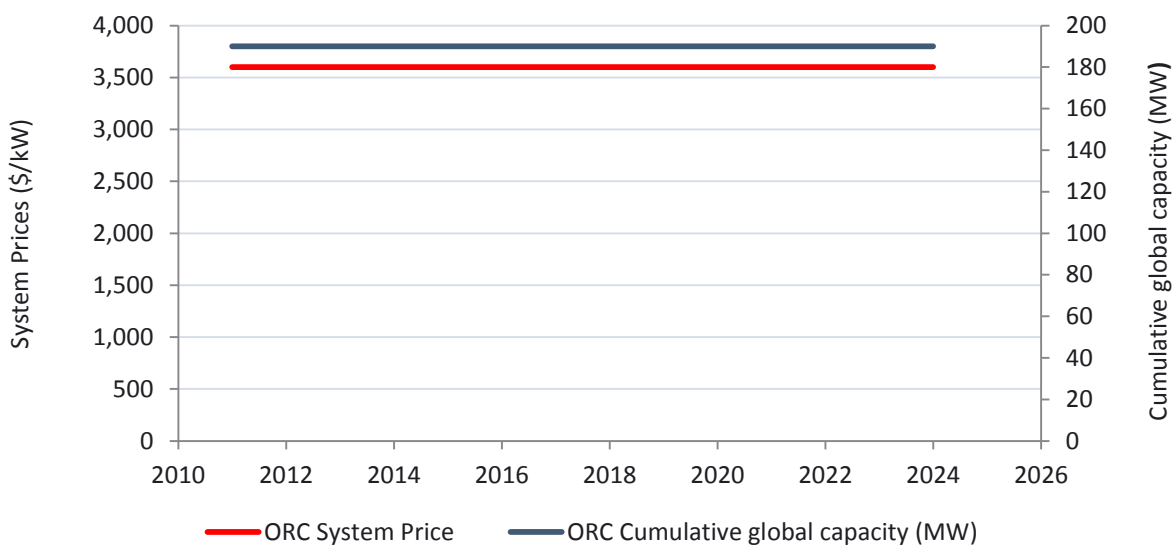
Developing Learning Curves

A flat progress ratio of 100% will be used to estimate future ORC cost/kW as no supporting data are available to generate other price trends.

Projected Future Costs

Figure A-37 summarizes the projected future costs and cumulative global capacity based on the growth rate and progress ratios defined above.

FIGURE A-37: PROJECTED FUTURE COSTS AND CUMULATIVE GLOBAL CAPACITY



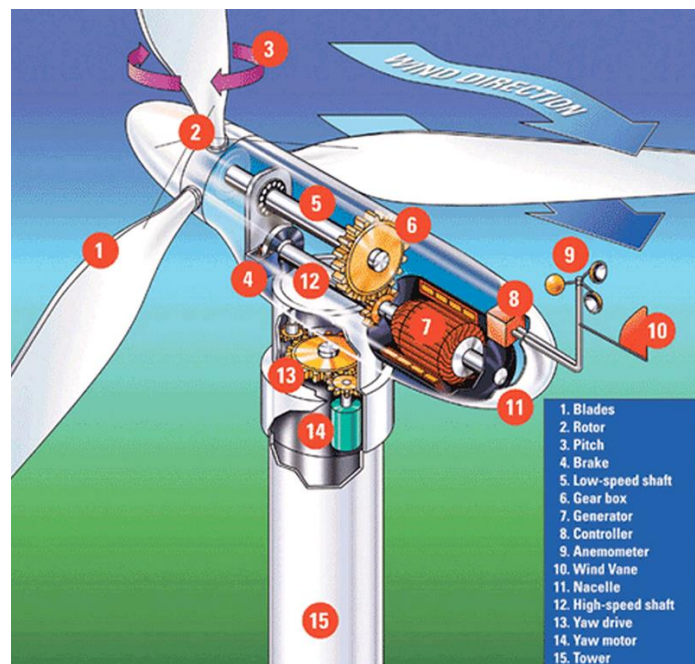
A.7 WIND

This sub-section provides a wind technology background and summary and describes the sources of capital and O&M cost estimates used in the SGIPce model. For the model, the wind capacities used and discussed below fall into two size categories: 50 kW and 1,500 kW.

Technology Summary

Wind turbines are typically two- or three-bladed fan-like structures that spin as the wind blows past the blades. A horizontal shaft at the center of the fan then turns a generator. The generator's electrical output, when conditioned properly, may be fed into the grid. Turbines usually are located atop tall towers where wind speeds can be much higher than near the ground. Figure A-38 shows the primary components of a wind turbine that has motorized yaw control (the ability to be turned to face directly into or away from the wind as needed). This is commonly found in turbines above 50 kW. Below 50 kW, wind turbines more commonly have yaw control by way of a "tail" that causes the rotor to be turned to face the wind directly. This tail may be automatically or manually controlled to adjust the yaw. This provides speed control of the rotor during very high winds or scheduled maintenance.

FIGURE A-38: WIND TURBINE COMPONENTS⁵²

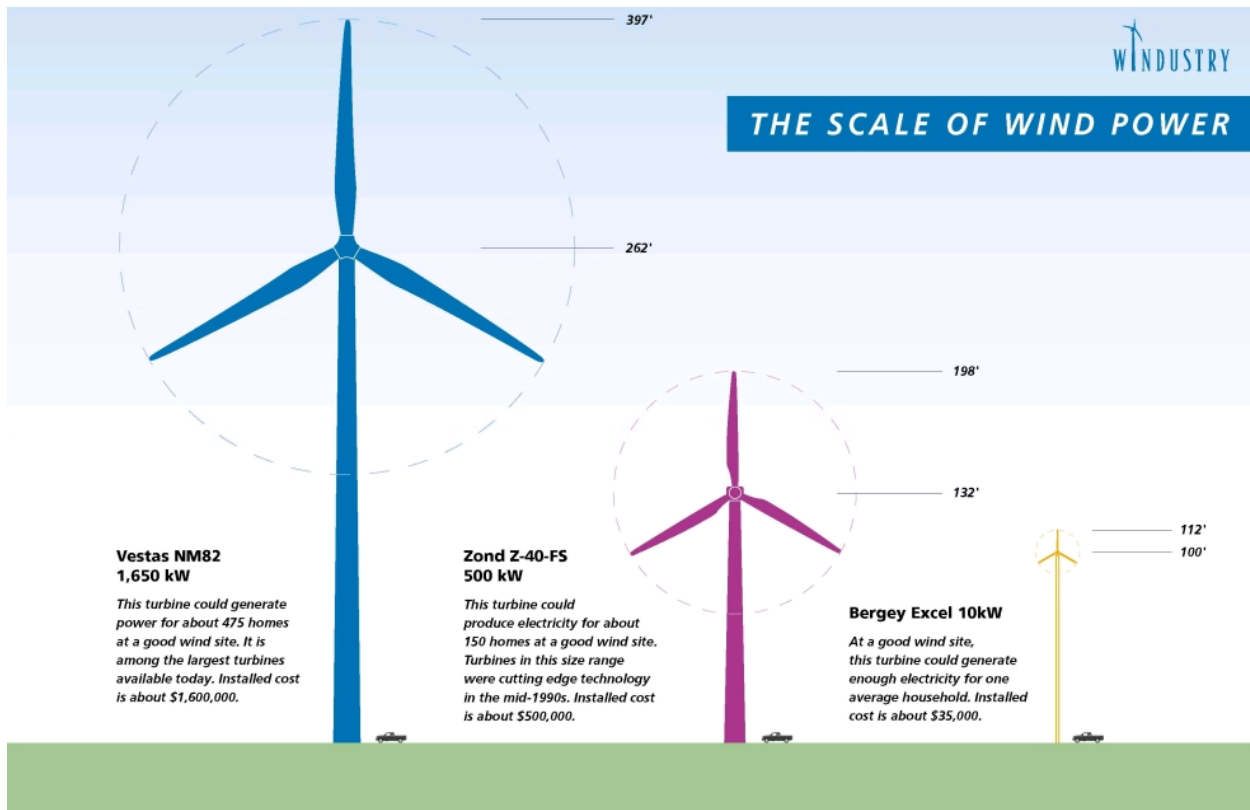


The turbine also has low and high speed shafts connected through a gearbox. Gearboxes are substantial components of most wind turbines both in terms of weight and cost. Being in the nacelle atop the tower, their weight also influences tower design and cost. In addition to motorized yaw control, larger wind turbines generally have more advanced controls and features than smaller turbines. These include blade pitch control that allows the blades themselves to be twisted. Pitch control can increase electrical output during low wind speeds by effectively changing the aerodynamics of the blade. Larger turbines also have taller towers so the blades can always be in faster moving winds.

⁵² <http://www.reuk.co.uk/Look-Inside-a-Commercial-Wind-Turbine.htm>

Figure A-39 shows the relative scale of several wind turbines, the smallest shown being 10 kW. The current industry standard for wind turbines over 100 kW is an upwind-facing, horizontal axis, three-bladed, blade pitch regulated unit housing a gearbox and an asynchronous generator all atop a tubular steel tower. Vertical axis turbines have not proved to be as cost-effective as horizontal axis turbines.

FIGURE A-39: SCALE OF WIND TURBINES⁵³



Wind turbines may be installed individually or in groups. Groups of turbines installed in close proximity are referred to as “wind farms.” A wide range of economic and geographic factors influence decisions on the number and capacity of turbines to install. A single, large turbine can have the same rated generating capacity (kW or MW) of a wind farm composed of many smaller turbines.

Regarding current wind trends in the United States, the DOE 2012 Wind Technologies Market Report states the following highlights surrounding the U.S. market:

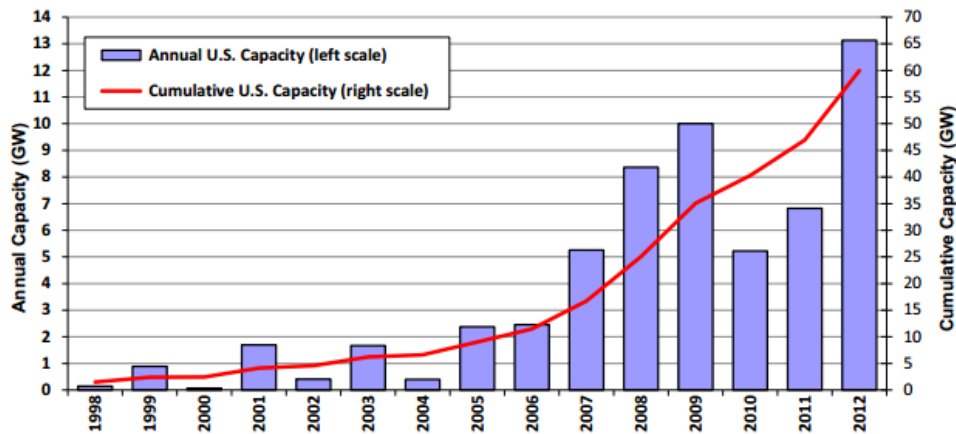
- » Wind power market achieved a new record in 2012, with 13,131 MW of new capacity added, bringing the cumulative total to approximately 60,000 MW Figure A-40.
- » This growth translates into \$25 billion (real 2012 dollars) invested in wind power project installation in 2012, for a cumulative investment total of \$122 billion since the beginning of the 1980s.

53 Windustry, “The Scale of Wind Power”. <http://www.maclester.edu/maccarees/Images/Turbine%20Scale%20-%20Windustry.jpg>



- » Wind power installations in 2012 were more than 90% higher than in 2011 and 30% higher than the previous record in 2009. Cumulative wind power capacity grew by 28% in 2012.
- » Key factors driving growth in 2012 included continued state and federal incentives for wind energy, the then-planned expiration of federal tax incentives at the end of 2012, and recent improvements in the cost and performance of wind power technology.

FIGURE A-40: ANNUAL AND CUMULATIVE U.S. CAPACITY



According to the DOE 2012 Wind Technologies Market Report, small wind systems (100 kW or less), can provide power directly to homes, farms, schools, businesses, and industrial facilities, offsetting the need to purchase some portion of the host’s electricity from the grid. Such wind turbines can also provide power to off-grid sites. Roughly 18.4 MW of small wind turbines were sold in the United States in 2012, with 86% of that capacity manufactured by U.S. companies. These installation figures represent a 3% decline in annual sales—in capacity terms—relative to 2011 and a larger decline relative to the peak year of sales in 2010. DOE (2013) reports that within this market segment there has been a general trend toward larger, grid-tied systems. The average U.S. small wind turbine unit size nearly doubled, from 2.6 kW in 2011 to 5 kW in 2012, while off-grid sales claimed just 5% of 2012 small wind turbine capacity, down from 9% in 2011. The average installed cost of U.S. small wind turbines in 2012 was reportedly \$6,960/kW, up 15% from 2011. The largest markets in 2012 were located in Nevada, Iowa, Minnesota, Alaska, and New York.⁵⁴

Technology Operating Characteristics

Wind turbines cannot be dispatched like conventional generation units. They also may have wide variations in power output. Their output depends on the local wind speed, air temperature, and air density, and so can be quite variable depending on location. This variability may have diurnal cycles, seasonal cycles, or both, again depending on location. Wind turbine manufacturers specify rated

⁵⁴ http://www1.eere.energy.gov/wind/pdfs/2012_wind_technologies_market_report.pdf



capacities of their turbine at specific atmospheric conditions; typically wind speeds over 30 miles per hour that are near ideal for continuous, high output. Turbines may generate above their rated capacities under different conditions, but generally they operate below their rated capacities.

The design of power conditioning equipment for turbines and wind farms must address the potential for variable output, particularly momentary lapses and surges in output. This is especially the case when interconnected to the grid. Depending upon their magnitudes, output lapses and surges may pose operational problems for transmission and distribution equipment and even for conventional generation units. If insufficient transmission capacity is available for power export, some wind farms cannot export all of their energy. Various forms of energy storage may be used to modulate turbine output. These include capacitive storage, beneficial for momentary variability and reactive power support to the grid, as well as pumped storage that permits the storage to be dispatched somewhat like conventional generation.

Proper selection of a site for a turbine depends largely on local atmospheric conditions. Locations with extreme wind gusts are avoided to reduce risk of potential damage to overstressed turbine components. Locations with high wind speeds during summer afternoon are preferable as their energy will have the most economic value if sold into the grid.

While without direct air pollutant emissions, wind turbines may pose environmental problems depending on location. Noise poses a problem near to and downwind of turbines. Visibility may be a problem. Site development may require new road building in areas with ecological sensitivities. Local and migratory bird and bat populations may be at risk while flying near turbines. The same is true for passing air traffic, and for ship traffic near offshore turbines. In a few cases radar interference has been a problem. These potential problems may raise costs related to obtaining local construction and operational permits, or may prevent installation altogether.

This section below provides descriptions of specific operating characteristics of 50 kW and 1,500 kW wind systems.

Useful Waste Heat Recovery

Does not apply to wind technology.

Criteria Air Pollution Emissions

Does not apply to wind technology.

Generation Profiles and Ramp Rates

Wind power is inherently intermittent. Generation can fluctuate greatly in short periods of time. Better wind sites, however, have predictable seasonal and diurnal periods of more and less wind. They also have more steady wind speeds and less gustiness. Rapid wind speed changes can stress mechanical



components so gusty sites are avoided despite having high wind speeds. Multiple turbines spread over a wide area can help smooth aggregate generation profiles.

While generally not ramped up or down like conventional generation sources, output from individual turbines can be controlled to a large degree. Blade pitch and generator controls and various braking mechanisms can be used to adjust power output from maximum available at a wind speed down to zero. Some newer turbines include energy storage systems to smooth generation profiles and improve power quality.

While hourly and daily generation profiles can be very irregular, monthly and seasonal profiles tend to be both smoother and more predictable. The profiles are driven by the site's wind resource that follows seasonal weather patterns that are well researched before a turbine is installed.

Annual capacity factors (ACF) of wind systems at the best wind resource sites may exceed 0.4. Sites anticipated to participate in SGIP would have good but not necessarily the best wind resource. The 2014 handbook requires evidence of an annual average wind speed minimum of 10 mph at a hub height of 80 feet. This requirement is in the first of seven levels of recognized wind power classes. For calculating performance based incentives the SGIP Handbook assumes an annual value of 0.25. At least one SGIP system has exceeded 0.3 although most are below 0.2. For modeling purposes, we assume 0.29 ACF for the 1,500 kW system and 0.22 ACF for the 50kW system.

Lifetime and Performance over Time

For both 50 kW and 1,500 kW wind systems a degradation factor of 1.1% is used in the model and comes from a benefit cost study that states "Forecasts of the annual degradation factor are based on a lognormal distribution function with a median value of 1.0 and a range of possible values from 0% to 5%. This means, in terms of annual, degradation forecasts, they can take any value between 0.0% and 5.0%, but will average between 1.1% and 1.2%. Thus, the downward adjustments to the unadjusted capacity factor are between 0% and 5% per year. Those adjustments reflect the consequences of the constantly aging equipment".⁵⁵

The lifetime of a 50 kW system is estimated at 30 years while the lifetime of a 1,500 kW system is estimated at 20 years. The 30-year lifetime estimate for the 50 kW system comes from a 10 kW wind performance specification sheet where the design operation life is 30-50 years.⁵⁶ The 2014 handbook requires wind systems to have a service warranty for a minimum of 20 years. The 20-year lifetime estimate for a 1,500 kW system comes from a 2010 LBNL study on the Value that the Federal Investment Tax Credit and Treasury Cash Grant Provide to Community Wind Projects. In the study they

55 A Benefit Cost Study of the 2015 Wind Challenge: An Assessment of Wind Energy Economics in Kansas for 2006–2034, 1/22/2008

56 http://bergey.com/documents/2013/10/excel-10-brochure_2013.pdf



state the economic lifetime of the wind systems to be 20 years.⁵⁷ Turbines may serve well beyond this time but it is an established basis for economic modeling.

Current Technology Capital Costs

The available literature for small wind turbines typically defines “small” systems as having capacities of 100kW or less. From 2004 to 2013, average costs per kW for small wind have been steadily increasing (from approximately \$4,300 / kW in 2004 to approximately \$6,900 / kW in 2013).^{58:59} A similar trend was seen for large wind from 2002-2008 due to: "... a decline in the value of the U.S. dollar relative to the Euro; increased materials, energy, and labor input prices; a general increase in turbine manufacturer profitability due in part to strong demand growth and turbine and component supply shortages; increased costs for turbine warranty provisions; and an up-scaling of turbine size, including hub height and rotor diameter."⁶⁰ It is unclear whether the same factors are driving the increase in costs for small scale wind, however. A representative from Pacific Northwest National Laboratory indicated that turnover of manufacturers in the small wind market and inconsistent sales cycles have led to stable or increasing costs.

An interview with the president of a small wind company concluded that costs for small wind turbines can vary a great deal based on the type of tower and many "low quality" companies use low quality towers. He said there are four or five primary "legitimate" manufacturers of small wind turbines. For turbines mounted on a "proper tower," the following costs were provided:

- » 1 to 2 kW - \$8,000 to \$10,000/kW
- » 2 to 5 kW - \$7,000 to \$8,000/kW
- » 5 to 15 kW - \$6,000 to \$8,000/kW
- » 15 to 100 kW - \$5,000 to \$7,000/kW

Current Technology Operating and Maintenance Costs

For 50 kW wind systems ICF suggests O&M costs to be \$0.013/kWh and \$21.7/year.⁶¹ With wind having an average capacity factor of 0.15, the \$21.7/year converts to \$0.017/kWh. This provides an overall O&M cost of \$0.03/kWh for the 50 kW wind. For 1,500 kW wind systems the O&M costs from three sources, 2011 to 2013, were \$0.011/kWh,⁶² \$0.010/kWh,⁶³ and \$0.090/kWh.⁶⁴ Thus, an average O&M of \$0.01/kWh is used in the model.

57 <http://emp.lbl.gov/sites/all/files/lbnl-2909e.pdf>

58 <http://www.deq.mt.gov/Energy/Renewable/WindWeb/pdf/AWEASmallWindReport2011.pdf>

59 2013 Wind Technologies Market Report US DOE EERE 2014

60 *ibid.*

61 The Cost and Performance of Distributed Wind Turbines Appendix B, 2010-2035 ICF 2010

62 <http://www.nrel.gov/docs/fy13osti/56266.pdf>



Total 2013 Cost Estimates

Table A-20 summarizes the cost data developed for 50 kW wind systems. Given that the majority of projects through the SGIP have been greater than 50 kW, the average 2013 cost of \$6,425/kW is appropriate for this category.

TABLE A-20: 50KW WIND SYSTEM COST ESTIMATES

	Cost Data
Average System Size (kW)	50
Electricity Generation System	
<i>Equipment</i>	4,049
<i>Labor</i>	2,188
<i>Balance of Plant</i>	-
<i>Additional Air Pollution Control</i>	-
<i>Other Costs</i>	215
System Cost per kW	6,452
Waste Heat Handling System (If Separate)	
<i>Equipment</i>	-
<i>Labor</i>	-
<i>Balance of Plant</i>	-
<i>Other Costs</i>	-
Waste Heat Handling Cost per Btu	-
	-
Biogas Capital Costs	
<i>Anaerobic Digester Gas Collection</i>	-
<i>Gas Clean Up</i>	-
<i>Other Costs</i>	-
Total Biogas Costs per kW	-
O&M Costs	
<i>Electrical</i>	0.03
<i>Biogas Capture</i>	-
<i>Biogas Clean Up</i>	-
<i>Air Pollution Control</i>	-
Total O&M Costs per kWh	0.03

63 http://www.wwindea.org/webimages/WWEA_Bulletin-ISSUE_3.pdf

64 http://emp.lbl.gov/sites/all/files/2013_Wind_Technologies_Market_Report_Final3.pdf



Table A-21 summarizes the cost data developed for 1,500 kW wind systems.

TABLE A-21: 1,500 KW WIND SYSTEM COST ESTIMATES

	Cost Data
Average System Size (kW)	1,500
Electricity Generation System	
<i>Equipment</i>	1,778
<i>Labor</i>	91
<i>Balance of Plant</i>	296
<i>Additional Air Pollution Control</i>	-
<i>Other Costs</i>	114
System Cost per kW	2,280
Waste Heat Handling System (If Separate)	
<i>Equipment</i>	-
<i>labor</i>	-
<i>Balance of Plant</i>	-
<i>Other Costs</i>	-
Waste Heat Handling Cost per Btu	-
	-
Biogas Capital Costs	
<i>Anaerobic Digester Gas Collection</i>	-
<i>Gas Clean Up</i>	-
<i>Other Costs</i>	-
Total Biogas Costs per kW	-
O&M Costs	
<i>Electrical</i>	0.01
<i>Biogas Capture</i>	-
<i>Biogas Clean Up</i>	-
<i>Air Pollution Control</i>	-
Total O&M Costs per kWh	0.01

For 1,500 kW systems, a total cost of \$2,280/kW value is recommended. The value is developed from recent sources and is within observed range of SGIP reported eligible costs for greater than 0.9 MW



wind total system capacities. Its equipment component cost also is very close to turbine transaction cost for systems with total capacity less than 5 MW.⁶⁵

Several of the data sources used to develop this cost reflect windfarms with total capacities much greater than 1,500 kW and with projects outside of California. These aspects potentially lower their unit costs relative to a single 1,500 kW system in California. Nevertheless, SGIP costs begin at \$1,900/kW (nominal) and peak at \$6,200/kW (nominal). Of the 52 total costs proposed in program tracking database, five are below the value recommended here. That 10% of proposed SGIP projects have lower unit costs indicates the recommended value is in fact reasonable for California and for smaller system total capacities. Furthermore, potential SGIP projects are expected to have relatively low land development and intertie costs as they would have only one to several turbines on properties already owned and near an existing load center. This tends to reduce Labor, BOP, and Other Costs and to make turbine transaction cost a larger percentage of total costs.

Estimating Future Capital Costs

In this section, we present the sources of data used when calculating learning curves and developing estimates of future costs. Growth rates and progress rations were developed for 50 kW and 1,500 kW wind technologies and detailed below.

Technology Growth

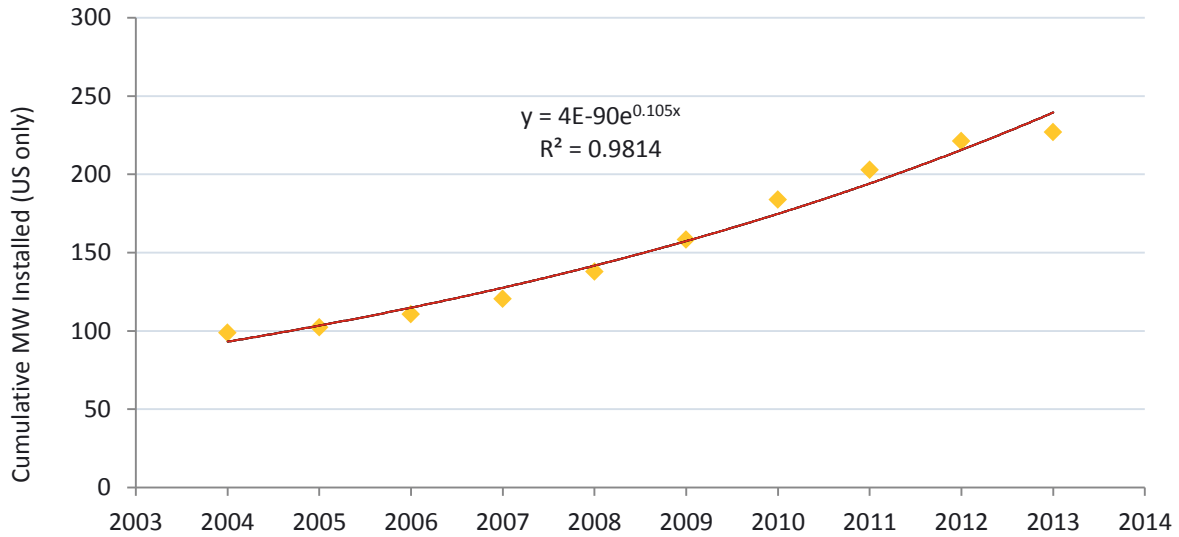
For 50 kW wind technology, the growth rate calculations are based on the 2013 US DOE Wind Technologies Market Report for small wind installations in North America.⁶⁶ Figure A-41 shows the yearly cumulative capacity installed and and curve fit. A linear growth model fits this data best and is used to calculate future growth. Based on these, we estimate an annual growth rate of 11% for 50 kW wind systems.

65 http://emp.lbl.gov/sites/all/files/2013_Wind_Technologies_Market_Report_Final3.pdf

66 http://emp.lbl.gov/sites/all/files/2013_Wind_Technologies_Market_Report_Final3.pdf



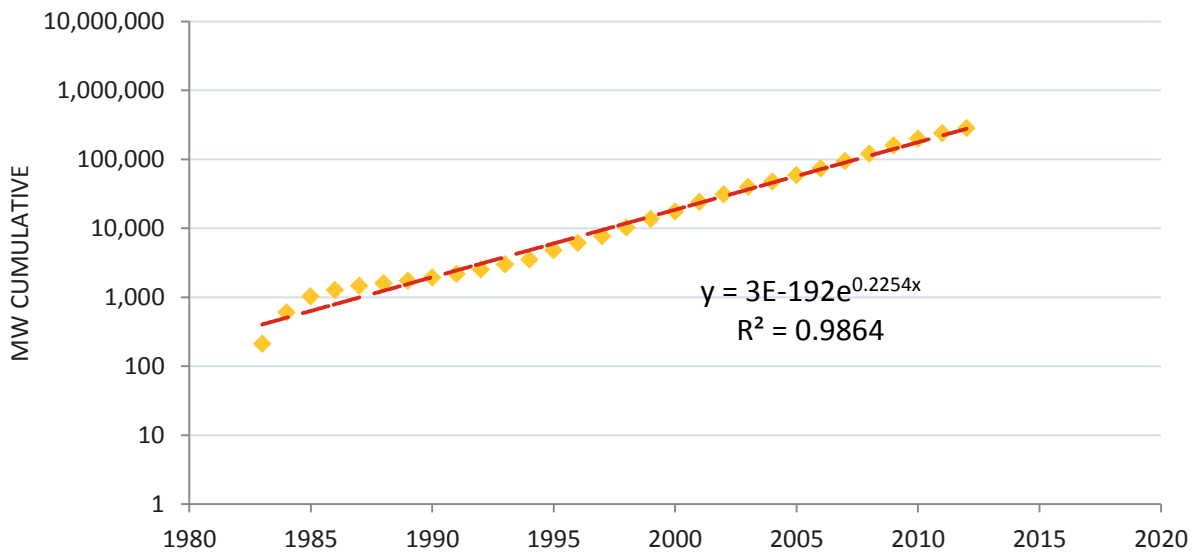
FIGURE A-41: 50 KW WIND SYSTEM GROWTH RATE



Source: http://eeredevapps2.nrel.gov/wind/windexchange/pdfs/2013_annual_wind_market_report.pdf

For 1,500 kW wind technology, high growth rates have been historically observed. Figure A-42 shows the yearly cumulative capacity installed and linear curve fit. We estimate an annual growth rate of 22.5% based on multiple decades of data from earth-policy.org.⁶⁷

FIGURE A-42: 1,500 KW WIND SYSTEM GROWTH RATE



Source: WindCumulativeMW_World_EPI_Apr2014.xlsx http://www.earth-policy.org/datacenter/xls/indicator10_2014_1.xlsx

67 http://www.earth-policy.org/datacenter/xls/indicator10_2014_1.xlsx



Developing Learning Curves

Learning curves are determined from the relationship between cumulative sales and costs per Watt. Learning curves were developed to represent two size breakouts: 50 kW and 1,500 kW, with each discussed below.

For 50 kW wind systems, literature review⁶⁸ and industry interview feedback shows that the cost for small wind has been increasing since 2004. Turnover of manufacturers in the small wind market and inconsistent sales cycles have also led to stable or increasing costs.⁶⁹ Federal policy and incentives have not been as strong a driver of small wind as they have with other technologies such as solar and large wind. Costs are expected to begin dropping based on several factors. First, there are only a handful of "legitimate" small wind manufacturers. These companies have established themselves in the market and are beginning to see steady and increasing market demand. The LCOE of small wind is expected to decrease 30-40% in the next five years according to personal communications with industry contacts. This is due to a combination of technology improvements that increase resource availability (larger rotors, lower cut-in speeds, etc.) and reduced manufacturing costs from increased volume. It was stated that it is very hard to reduce manufacturing costs without increasing volume and volume is driven by policy. Small wind volume is expected to increase 50-100% per year for the next few years due to new aggressive incentive policies in New York, Iowa, and Minnesota, among others. A progress ratio of 92% to 94% was recommended in an interview⁷⁰ although some literature suggests a negative learning rate of up to -48%.⁷¹ While the literature suggests steadily increasing costs, industry experts do not expect this trend to continue. Given the available information, we recommend a modest learning rate of 5% with a progress ratio of 95%. Figure A-6 shows installed costs for small wind turbines (\$/kW) as a function of cumulative installed capacity in the U.S.

68 <http://www.deq.mt.gov/Energy/Renewable/WindWeb/pdf/AWEASmallWindReport2011.pdf>

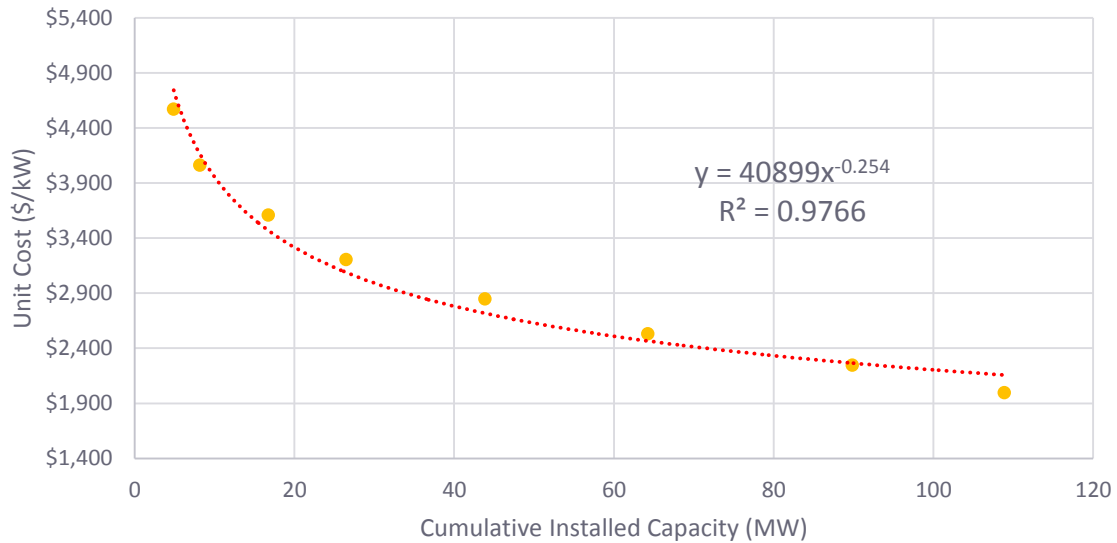
69 Pacific Northwest National Laboratories interview

70 President of a small wind and distributed wind company

71 <http://www.deq.mt.gov/Energy/Renewable/WindWeb/pdf/AWEASmallWindReport2011.pdf>

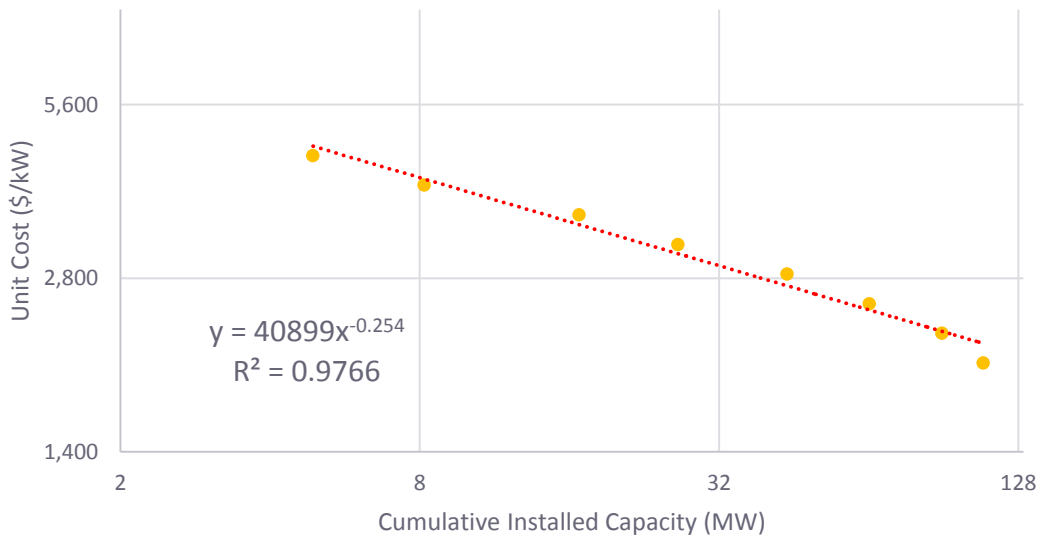


FIGURE A-43: 50 KW WIND SYSTEM LEARNING CURVE



Source: <http://www.deq.mt.gov/Energy/Renewable/WindWeb/pdf/AWEASmallWindReport2011.pdf>

FIGURE A-44: LOG-LOG 50 KW WIND SYSTEM LEARNING CURVE



For 1,500 kW wind systems the progress ratio is also based on installed cost. The ratio indicates a 6.7% cost reduction per doubling of capacity aggregate. This reduction is less than other values from literature review and thus more conservative as far as hoping costs decrease. A 2013 NREL report shows an 11% reduction using 2004 data for California,⁷² and Wiser's⁷³ shows a 9% reduction using 2009 data

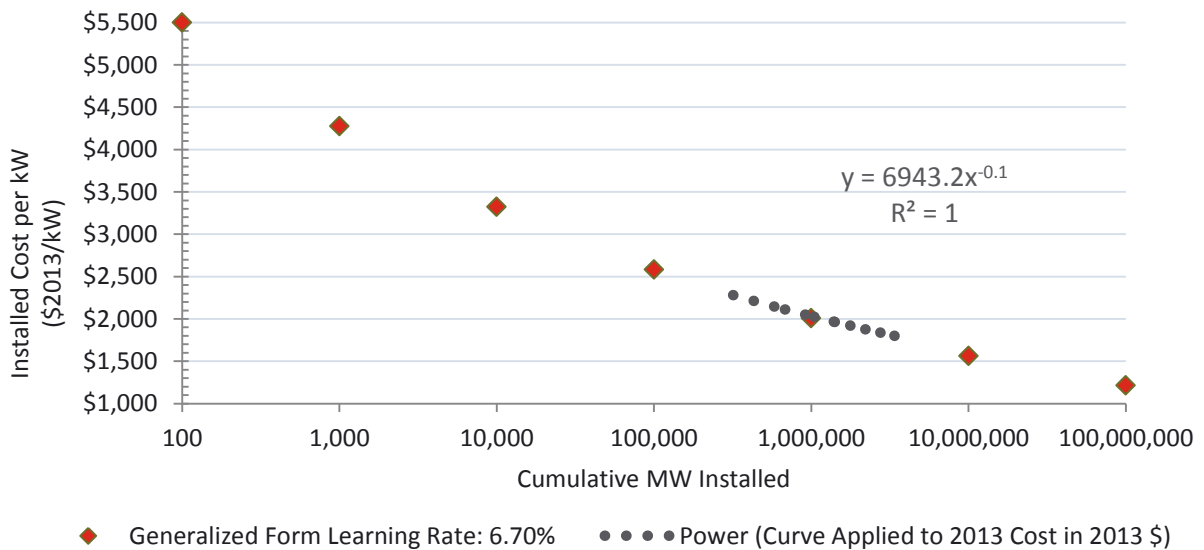
72 http://emp.lbl.gov/sites/all/files/2013_Wind_Technologies_Market_Report_Final3.pdf

73 <http://www.cesa.org/assets/Uploads/Wiser-2013-RPS-Summit-Presentation.pdf>



and U.S. investment costs as the dependent variable. Wiser's data from 2010-2012, although decreasing from 2009 costs, effectively lower the reduction from 9.3% to the 6.7% recommended here. One reason costs are falling less is newer turbines are substantially better than older.⁷⁴ Figure A-45 shows 1,500 kW wind product sales and revenues per Watt sold.

FIGURE A-45: 1,500 KW WIND SYSTEM LEARNING CURVE



Sources: WindEnergyCostPerformanceTrends_LBNL_Wiser_2013.pdf <http://www.cesa.org/assets/Uploads/Wiser-2013-RPS-Summit-Presentation.pdf>

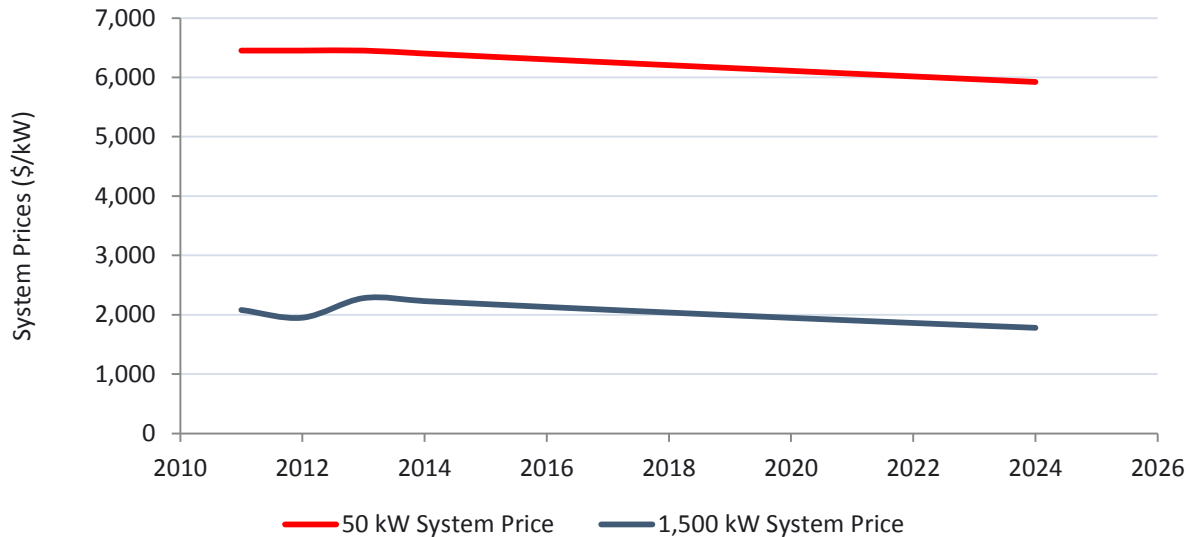
Projected Future Costs

Figure A-46 summarizes the projected future costs of 50 kW and 1,500 kW wind systems based on the progress ratios defined above.

74 <http://www.nrel.gov/docs/fy13osti/56266.pdf>



FIGURE A-46: PROJECTED FUTURE COSTS



A.8 STORAGE

This sub-section provides an advanced energy storage (AES) technology summary and describes sources of capital cost and O&M cost estimates used in the SGIP Cost-Effectiveness model.

In addition to the SGIP, AES has further been boosted by Assembly Bill (AB) 2514 (Skinner, 2010). This bill mandated that California IOUs procure 1,325 MW of storage by 2020. Two hundred MW was targeted to be ‘behind the meter’. This behind the meter, customer-owned storage is the same category that the SGIP supports.

Behind the meter/customer-owned storage has been identified in CPUC Decision 13-10-040, Table 1, P. 14, 2013 to serve three purposes:

- » Power Quality
- » Electric Vehicle Charging
- » Bill Management/Permanent Load Shifting

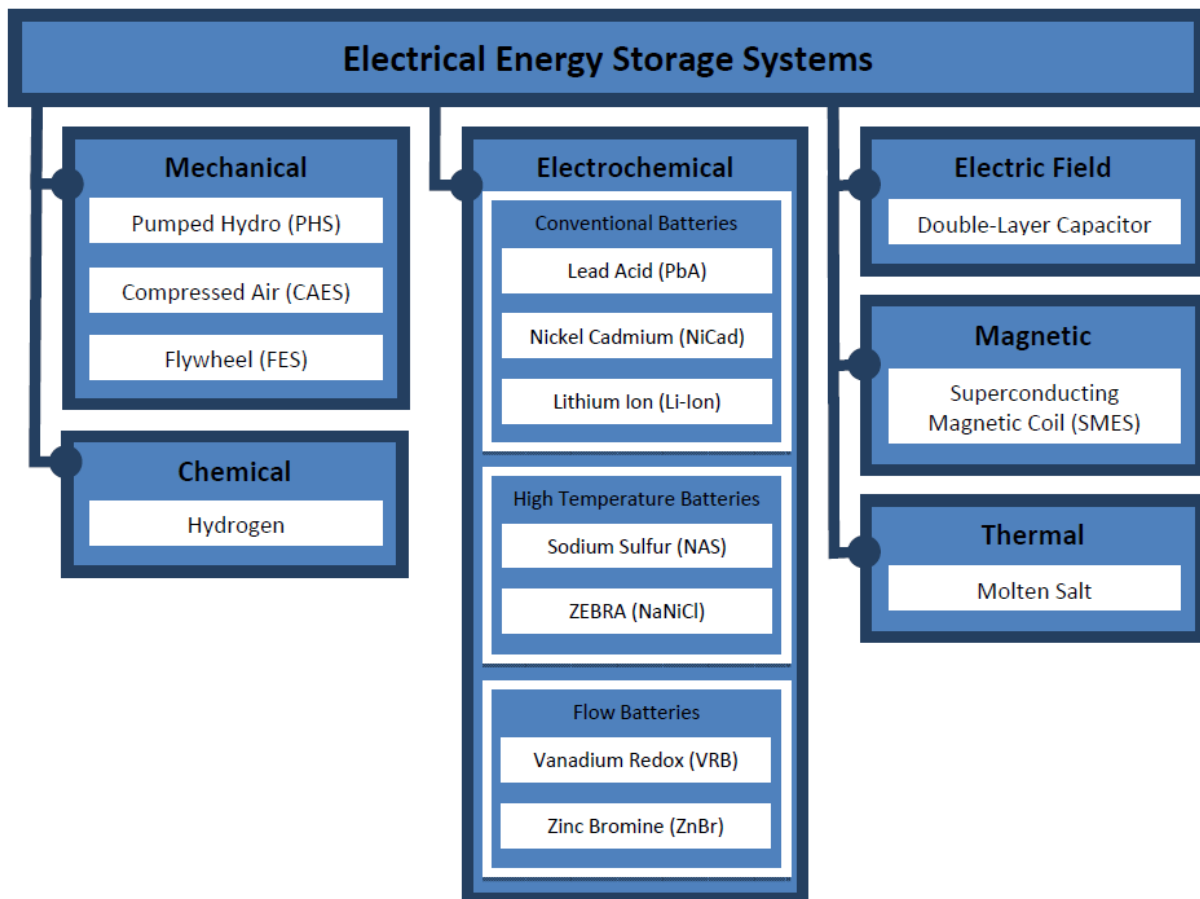
Our research into SGIP market transformation and our management of the California Solar Initiative (CSI) Research Development and Deployment (RD&D) grant program indicated that the primary purpose and revenue stream for commercial AES is bill management, particularly of demand charges. Some vendors are working to monetize power quality and electric vehicle charging but the primary stream for commercial storage is bill management. Therefore, demand charge reduction was selected as the primary operating model for this analysis.

Technology Summary

AES is a relatively new technology for the SGIP. AES technologies convert electricity into energy, store it, and then convert the energy back into usable electricity when needed. Batteries have been used for backup power and off-grid applications for many decades, but the advanced peak shaving and (potential) grid support functions of AES are a relatively new development. AES technologies can be implemented on large and small scales in distributed and centralized manners throughout the energy system.

There are a wide variety of possible forms in which the energy can be stored. Classification of Energy Storing Technologies can be shown in Figure A-47.

FIGURE A-47: STORAGE TECHNOLOGIES⁷⁵



75 Rachel Carnegie et al State Utility Forecasting Group - Utility Scale Energy Storage Systems, June 2013.

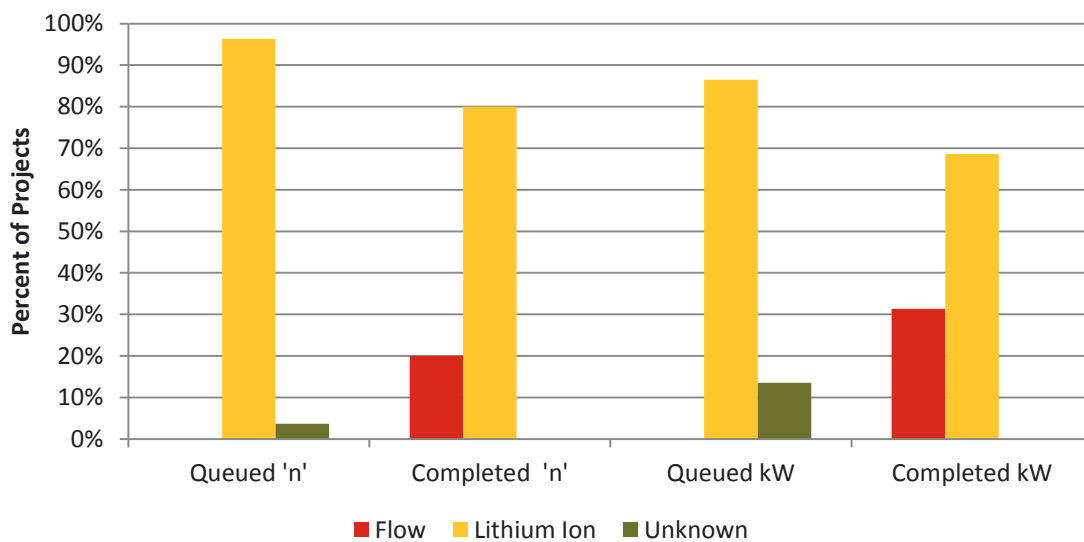


From the standpoint of the electrical system, these energy storage methods act as loads while energy is being stored (e.g., while charging a battery) and sources of electricity when the energy is returned to the system (e.g., while discharging a battery).

Even though there are several technologies available in the market, SGIP AES is currently dominated by electrochemical technologies. We chose to focus on two of these technologies—Lithium-Ion and Flow Batteries—since these dominate installed systems and the queue of applications.

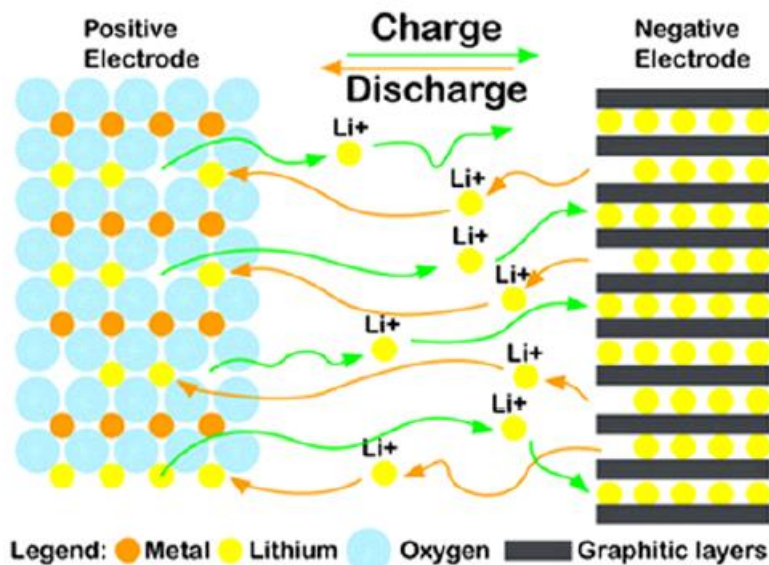
Lithium-Ion: Figure A-48 shows how this technology currently dominates the SGIP program.⁷⁶

FIGURE A-48: FRACTION OF PROJECTS BY TYPE OF STORAGE



Lithium-Ion batteries components include: a carbon (graphite) negative electrode, a metal-oxide positive electrode, an organic electrolyte (ether) with dissolved lithium ions, and a micro-porous polymer separator. When the battery is charging, lithium ions flow from the positive metal oxide electrode to the negative graphite electrode. When the battery is discharging the reverse flow of ions takes place (see Figure A-49).

⁷⁶ Most of the queued projects do not have a rigorous technology type assigned. This graph assumes that SolarCity/Tesla, GreenCharge Networks, CODA, Stem, and PowerTrees all use Lithium-Ion cells.

FIGURE A-49: LITHIUM-ION BATTERY CHEMISTRY⁷⁷


For Lithium-Ion, we assumed a two hour discharge rating to match SGIP program rules, or the power rating is one half of the energy capacity. For example, a 30 kW battery would store 60 kWh of energy, and a residential 5 kW battery would store 10 kWh of energy.

Flow batteries are typically larger and have more capacity. Redox flow batteries are a reversible fuel cell in which electro-active components are dissolved in the electrolyte. A redox flow battery's energy is related to electrolyte volume and power is related to electrode area in the cells. Common redox flow battery chemistries include zinc bromine and vanadium. There is currently one active project in SGIP with this technology. We used a nominal four-hour capacity since flow batteries tend to have less kW per kWh and discharge slower than more power focused Lithium-Ion batteries.

Technology Operating Characteristics

This section provides a description of the operating characteristics of the technology.

Typical Efficiencies

Storage efficiencies are somewhat different than other technologies. Rather than converting a fuel to electricity and heat, AES takes grid electricity in the form of alternating current (AC), converts that energy to direct current (DC), stores that energy in a battery, releases that energy, converts the energy

⁷⁷ Rachel Carnegie et al. State Utility Forecasting Group - Utility Scale Energy Storage Systems, June 2013.



back to AC, and serves host customer loads.⁷⁸ Storage efficiencies are a ‘round trip’ AC-to-AC efficiencies of AC grid power to DC battery and then DC battery power back to AC grid (or host site) power.

The efficiency of energy storage devices varies widely across technologies, ranging from about 65% to as high as 88%. Lithium-Ion efficiencies are on the higher side compared to other technologies and were set at 84% roundtrip AC/AC based on an average efficiency from the following reports:

- » Average efficiencies (88%) from the ES Select Tool by Sandia National Labs and DNV/GL (formerly KEMA)
- » EPRI, Cost-Effectiveness of Energy Storage in California, Application of the EPRI Energy Storage Valuation Tool to Inform the California Public Utility Commission Proceeding R. 10-12-007, 3002001162, June 2013 (83%)
- » Viswanathan et al. National Assessment of Energy Storage for Grid Balancing and Arbitrage Phase II Volume 2: Cost and Performance Characterization, PNNL- 21388 PHASE II/Vol.2, Pacific Northwest National Lab, September 2013 (80%)
- » Round trip efficiency reported by SolarCity as part of the SolarCity California Solar Initiative Research Development, and Deployment grant (81%)

We set Flow Battery Efficiencies at 70% based on an average from the following sources:

- » Average Efficiencies (65%) from the ES Select Tool by Sandia National Labs and DNV/GL (formerly KEMA)
- » EPRI, Cost-Effectiveness of Energy Storage in California, Application of the EPRI Energy Storage Valuation Tool to Inform the California Public Utility Commission Proceeding R. 10-12-007, 3002001162, June 2013 (75%)
- » Grid Scale Energy Storage Conference (San Diego, June 2014) Providing Distributed Capacity in the Pacific NW (Primus Power, Thomas Stepien) (high 60%, set at 67%)
- » Viswanathan et al., National Assessment of Energy Storage for Grid Balancing and Arbitrage Phase II Volume 2: Cost and Performance Characterization, PNNL- 21388 PHASE II/Vol.2, Pacific Northwest National Lab, September 2013 (75%)

Useful Waste Heat Recovery

Not applicable to AES.

⁷⁸ Potentially, the stored energy could be exported back to the electrical grid. However, since this analysis is restricted to energy storage not paired with renewable sources such as solar, said energy storage is not eligible for net energy metering (NEM) in this analysis. Therefore, energy released from storage is assumed to be consumed on site and not exported to the grid.



Greenhouse Gas and Criteria Air Pollution Emissions

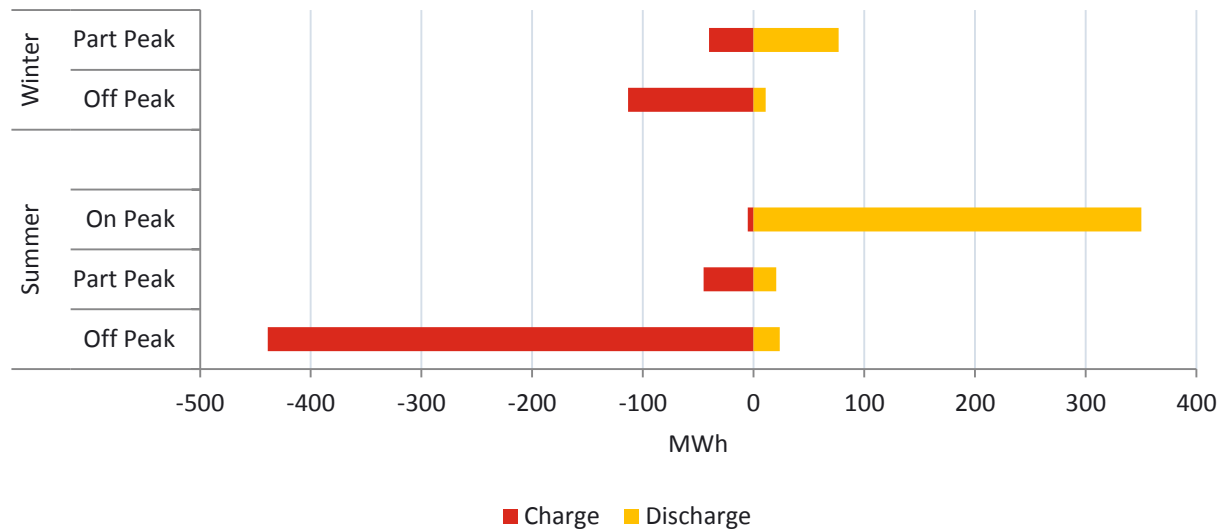
Not directly applicable to AES although indirectly applicable due to interaction with the grid.

Generation Profiles and Ramp Rates

Behind-the-meter energy storage primarily operates to reduce customer peak demand.⁷⁹ Because storage is not 100% efficient, the use of storage actually increases energy consumption, making it quite unique amongst SGIP technologies.

Since the demand profile is site-specific, we used a proxy of looking at peak TOU times and set storage to discharge during peak hours and then recharge overnight when rates are much lower. Figure A-50 shows the timing of charge and discharge for sites with data in the 2013 SGIP Impacts Evaluation (Also Figure 8-3 in that report).

FIGURE A-50: SGIP STORAGE CHARGE & DISCHARGE TIMING (CASE STUDY OF TOU LOAD SHIFTING)



Monthly demand savings are due to the reduction of the 15 minute peak in each month and split into three sectors:

- » On Peak; billed on the maximum kW demand during peak hours
- » Semi-Peak; billed on the maximum kW during semi-peak hours
- » Max Demand; billed on the maximum kW during the month

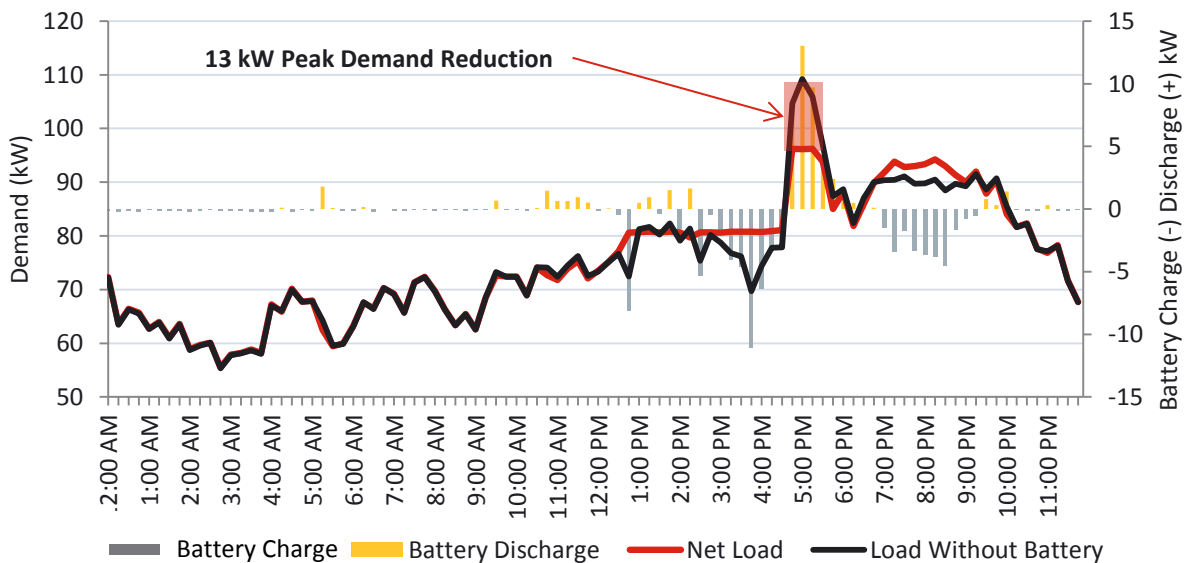
Demand savings are estimated as a fraction of installed capacity.

⁷⁹ Based on interviews with storage manufacturers and developers during the SGIP Market Transformation work



The use of intelligent controllers that run the charge and discharge cycles of storage based on several operating and cost parameters to create desired load profiles is finding increasing use in the field. Figure A-51 (also Figure 8-1 in the 2013 SGIP Impacts Report) illustrates the use of storage at a hotel to reduce peak demand. In doing so, the customer reduces the peak demand for that day 13kW and potentially reduces the magnitude of the billed demand charge. Note that this is for a nominally 9 kW system (18 kWh).

FIGURE A-51: BATTERY USE CASE FOR PEAK DEMAND REDUCTION IN APRIL



The peak on this day in April is about an hour long, so the storage system is able to achieve demand savings in excess of the system’s two hour rated capacity. During hotter days when peaks are longer and these peaks are likely cooling load induced, the storage system is less able to reduce the peak demand, as shown in Figure A-52. On this day, the storage system was only able to reduce peak demand by 4 kW.



FIGURE A-52: BATTERY USE CASE FOR PEAK DEMAND REDUCTION IN JULY

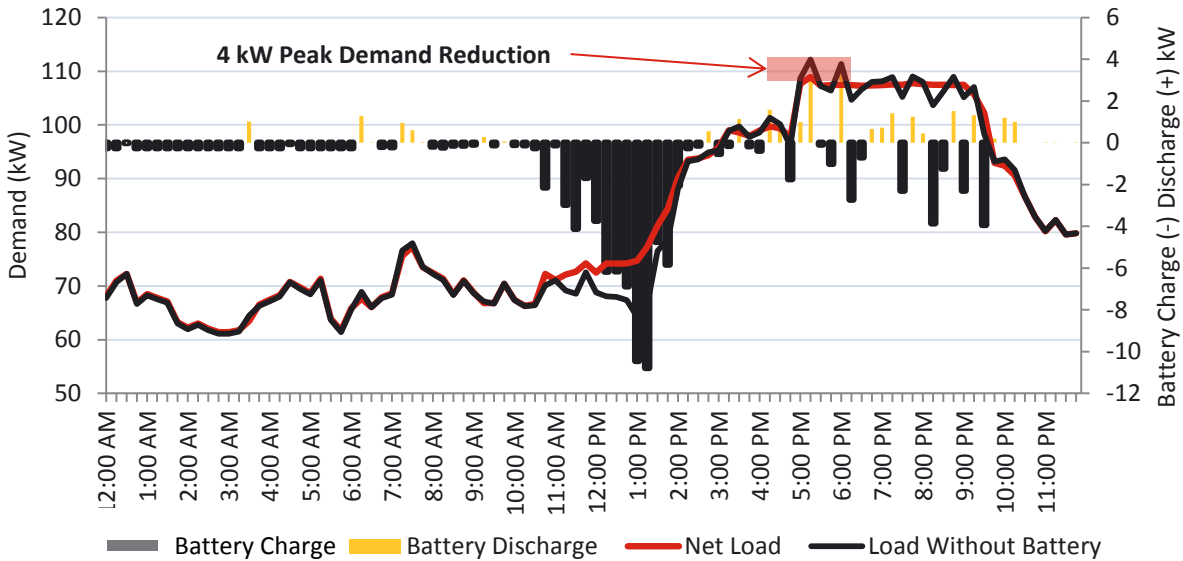
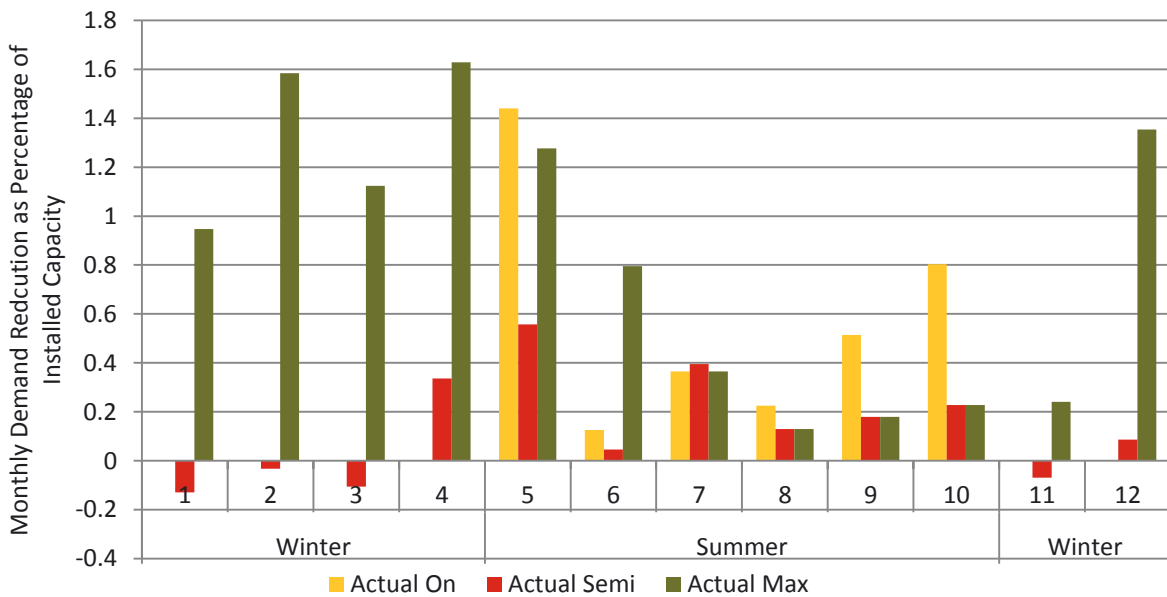


Figure A-53 shows what fraction of system capacity is realized as demand savings over a year for the system shown in Figure A-51 and Figure A-52. A 100% fraction indicates that all of the storage capacity shows as demand savings; for example, a 100 kW AES systems would show 100 kW of monthly demand savings. Demand savings over 100% are possible since many AES systems can discharge at greater than the two hour rate.

FIGURE A-53: ACTUAL STORAGE DEMAND REDUCTION





We averaged the actual demand impacts by season for this system and others to develop the fraction of capacity that can be applied demand savings per period for use in the model. Figure A-54 shows the fractions developed and used. The 50% offset in summer matches the average minimum offset calculated by NREL's Behind-The-Meter Energy Storage (BLAST)⁸⁰ program. Summer peak demand savings are less than winter since summer peaks tend to be much longer and driven by cooling loads. The discharge of the system was simulated as:

- » In winter, discharges at SGIP capacity⁸¹ for an hour on winter peak everyday, and 60% of SGIP capacity for an hour after that. This preserves a 20% margin for battery life management
- » In summer, discharges everyday at 50% of SGIP capacity for two hours on peak, and one hour at 25% of SGIP capacity on semi peak or on peak. Combined with the winter discharge, this meets the expected SGIP PBI operation of 520 hours at capacity per year.

We included weekends in the discharge model because many utilities charge a significant amount based on the absolute maximum demand, regardless of what period the maximum occurs in. The actual reductions are based on the average system discharge (that is not zero) during each period, with a 0.8 demand savings ratio like other technologies. This averaging approach is different than other SGIP technologies where the demand savings are based on the minimum output during each period. We selected average for storage because most AES commercial systems being installed are controlled using forecast algorithms to minimize peak demand⁸² and, given the short discharge of storage, the use of minimum would result in no demand savings.

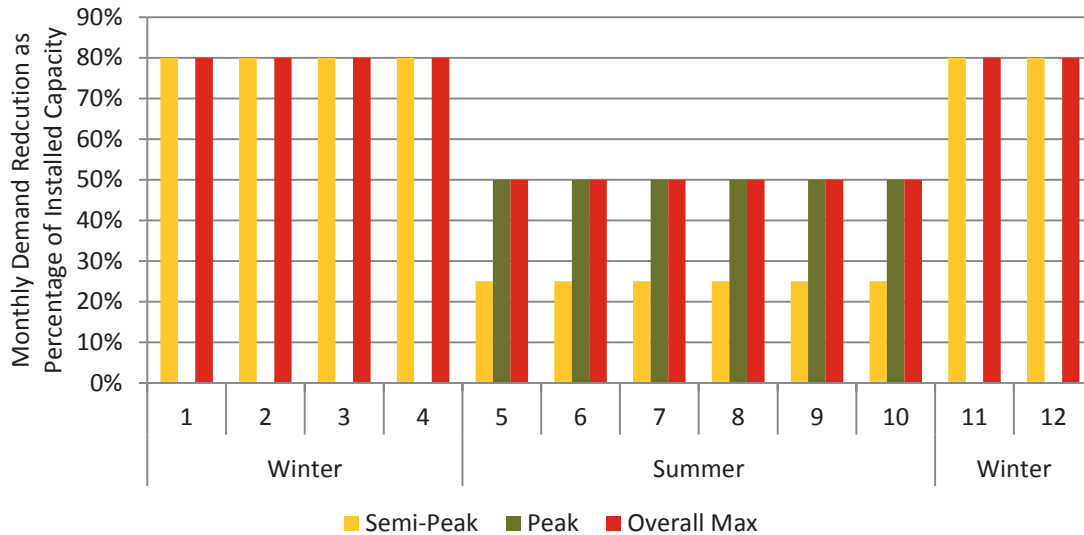
⁸⁰ Neubauer and Simpson, Deployment of Behind-The-Meter Energy Storage for Demand Charge Reduction, NREL/TP-5400-63162 January 2015

⁸¹ Per the SGIP handbook, SGIP capacity is the output the system could maintain for 2 hours. For example, a 60 kWh energy capacity Lithium Ion system would have a SGIP rating of 30 kW.

⁸² This is based on our examination of metered data and conversations with the manufactures and installers (as part of the SGIP Market Transformation work) that comprise over 95% of the applications in SGIP queue for AES systems.



FIGURE A-54: AVERAGED NON-ZERO STORAGE DISCHARGE (BEFORE APPLICATION OF 0.8 DEMAND SAVINGS RATIO)



Lifetime and Performance over Time

Lithium-Ion

Lifetime and performance over time for the Energy Storage technologies varies significantly depending on the application, discharge rate, and the number of discharge cycles. A Lithium-Ion battery typically lasts for 10⁸³ to 24⁸⁴ years. Based on the research, we used an average lifetime of 15 years in the analysis for the Lithium-Ion batteries. The expected lifetime is related to the cycling depth of discharge and the Li-Ion batteries should not be used for applications that require full discharge.

Flow Batteries

Typical lifetime for the flow batteries are in the range of 15⁸³ to 20⁸⁵ years. For the analysis, we used an average lifetime of 17 years for the flow batteries.

Current Technology Capital Costs

As part of the literature review, capital costs from various sources were reviewed and were also validated by communication with the storage vendors and cost data from energy storage conference.

83 EPRI, Cost-Effectiveness of Energy Storage in California, Application of the EPRI Energy Storage Valuation Tool to Inform the California Public Utility Commission Proceeding R. 10-12-007 -3002001162, June 2013

84 Average Lifetime for Lithium-ion High and Low Power batteries from ES Select tool developed by EPRI/KEMA

85 Average Lifetime for Vanadium Redox Battery and Zinc Bromide batteries from ES select tool developed by Sandia/KEMA



Based on the review, we used an average total system cost of \$3,044 per kW for Lithium-Ion batteries and \$3,082 per kW for flow batteries. We used the following references to determine the average system cost:

Lithium-Ion Battery

- » Costs documented the in ES Select tool by Sandia/KEMA
- » Viswanathan et al. National Assessment of Energy Storage for Grid Balancing and Arbitrage Phase II Volume 2: Cost and Performance Characterization, PNNL- 21388 PHASE II/Vol.2, Pacific Northwest National Lab, September 2013
- » Akhil et al. DOE/EPRI 2013 Electricity Storage Handbook in Collaboration with NRECA, SANDIA REPORT SAND2013-5131, July 2013
- » Edgette, Energy Storage presentation at Itron Utility week, 2013 (re-quoting DOE/NEDO projects)
- » Bryan, Integration of Solar and Storage Large Scale Results, presentation at Itron Utility week, 2013

Flow Battery

- » ES Select documentation (tool by Sandia National Labs and KEMA)
- » Stepien, Providing Distributed Capacity in the Pacific NW, Grid Scale Energy Storage Conference (San Diego, June 2014)
- » Viswanathan et al. National Assessment of Energy Storage for Grid Balancing and Arbitrage Phase II Volume 2: Cost and Performance Characterization, PNNL- 21388 PHASE II/Vol.2, Pacific Northwest National Lab, September 2013
- » Akhil et al. DOE/EPRI 2013 Electricity Storage Handbook in Collaboration with NRECA, SANDIA REPORT, SAND2013-5131 July 2013

Current Technology Operating and Maintenance Costs

For battery technologies, O&M costs are generally split into fixed and variable components. The fixed component is incurred every year regardless of the energy requirement, while the variable component is proportional to electrical energy (kWh) throughput. For Lithium-Ion batteries, operational and maintenance costs⁸⁶ of \$0.0283 were used in the analysis where as for the flow batteries, operational and maintenance costs of \$0.075 were used. The same references listed in the “Current Technology Capital Costs” section were used to estimate the operational and maintenance costs.

Total 2014 Cost Estimates

Table A-22 shows the cost estimates for the three storage technologies and sizes.

⁸⁶ This includes both fixed and variable O&M costs.



TABLE A-22: STORAGE COST ESTIMATES

	Res 5 kW	NonRes 30 kW	NonRes 5 MW
Average System Size (kW)	5	30	5,000
Electricity Generation System			
<i>Equipment</i>	\$1,802.00	\$1,802.00	\$1,878.78
<i>Labor</i>	\$503.72	\$503.72	\$668.79
<i>Balance of Plant</i>	\$738.19	\$738.19	\$534.43
<i>Additional Air Pollution Control</i>			
<i>Other Costs</i>			
System Cost per kW	\$3,043.92	\$3,043.92	\$3,082.00
Waste Heat Handling System (If Separate)			
<i>Equipment</i>			
<i>Labor</i>			
<i>Balance of Plant</i>			
<i>Other Costs</i>	-		
Waste Heat Handling Cost per Btu	-		
Biogas Capital Costs			
<i>Anaerobic Digester Gas Collection</i>			
<i>Gas Clean Up</i>			
<i>Other Costs</i>			
Total Biogas Costs per kW			
Total System Cost	\$3043.92	\$3043.92	\$3082.00
O&M Costs			
<i>Electrical</i>	\$0.028	\$0.028	\$0.075
<i>Biogas Capture</i>			
<i>Biogas Clean Up</i>			
<i>Air Pollution Control</i>	-	-	-
Total O&M Costs per kWh	\$0.028	0.028	\$0.075

Estimating Future Capital Costs

This section presents the sources and bases for estimating future costs based on current costs. The future costs are based on technology growth predictions and learning curves estimates.



Technology Growth

Storage is a new technology poised for explosive growth without a substantial track record to base growth rates on. Year over year growth rates are adapted from the following two sources:

- » Cheung, Battery Innovation: Incremental or Disruptive? Bloomberg New Energy Finance, which showed a year over year growth rate of 25% on annual installs.
- » Koritarov, Electrical Energy Storage Technologies and Applications Workshop, Grid-Scale Energy Storage, March 20, 2013, which observed a growth rate of 37% year over year on annual installs.

The growth rate used in the model, however, is based on cumulative geometric growth. Therefore, we converted the average year-over-year annual growth rate of 31% by calculating what the cumulative growth rate would need to be to match the installed volume in 2024. The cumulative growth rate of 50% was selected to match the same volume in 2024 as a year over year annual growth rate of 31%.

Developing Learning Curves

Again, storage is a relatively new technology. However, the computer industry and transportation industries provide substantial data for Lithium-Ion cost reduction curves. The primary references for this are the following that are averaged for a progress ratio of 80%.

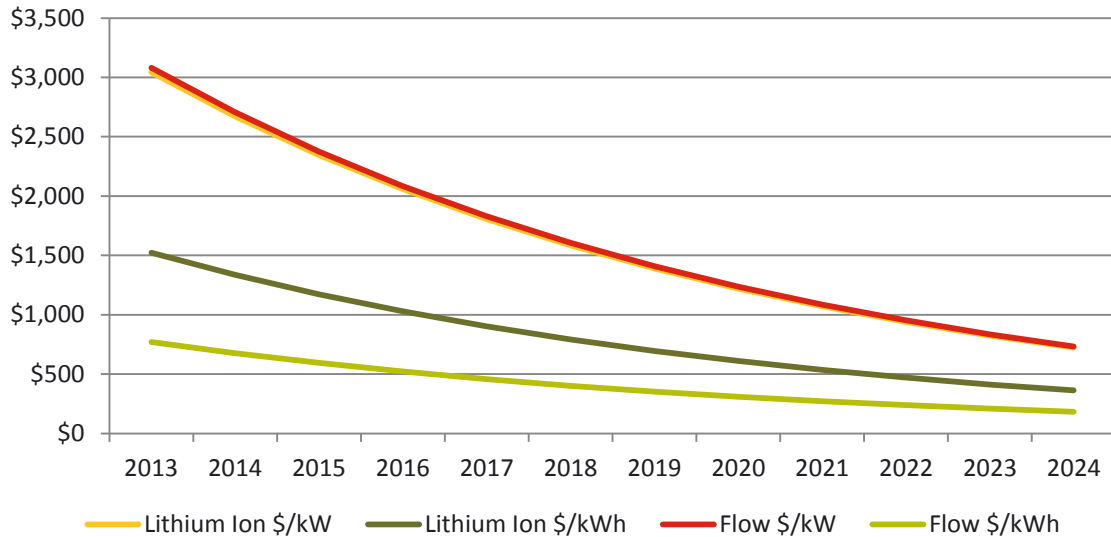
- » Hoffman, PV As One Of The Major Contributors To A Future 100% Renewably Powered World – Importance And Evidence For Cost Effective Electricity Storage, 29th European Photovoltaic Solar Energy Conference and Exhibition that shows a progress ratio of 85%
- » Liebreich, 2013-04-23-BNEF-Summit-2013-keynote. Presentation shows a progress ratio of approximately 75%

Projected Future Costs

The resulting cost reductions from these growth rates and learning curves are shown in Figure A-55.



FIGURE A-55: FUTURE COSTS ON \$/KW AND \$/KWH BASIS



A.9 PRESSURE REDUCTION TURBINE

This sub-section provides summary of pressure reduction turbine technology and describes the sources of capital and O&M cost estimates used in the SGIPce model. No learning curves or growth models are presented as these data were not available from any literature or manufacturer sources.

Technology Summary

Pressure reduction turbines are in-conduit hydroelectric generation turbines that take advantage of the need to dissipate conduit pressure as water is moved from a higher elevation intake to a lower elevation outlet. These turbines are usually installed in existing piping systems. Pressure reduction turbines can be considered an efficiency measure when they replace pressure reduction valves in favor of generating on-site power. The turbines are available custom made or off the shelf pumps run as turbines. The equipment comes in ranges from 5 kW to 500 kW. The cost-effectiveness model considers the 400 kW case. Figure A-56 shows a typical in-conduit application of a pressure reduction turbine.

FIGURE A-56: TYPICAL PRESSURE REDUCTION TURBINE CONFIGURATION

Technology Operating Characteristics

Pressure reduction turbines are a special application of hydroelectric generation technology and are a reliable and well proven technology. In closed water pipeline distribution systems, water will be pumped through at some points and at other points needs to flow with decreased pressure. Pressure reduction turbines placed inside such a pipe system are used to generate electricity. Pressure reduction turbine applications use existing infrastructure typical of water and waste water treatment facilities and allow facilities operators to generate electricity by dissipating water system pressure through a turbine. There are two main types of turbines used depending on the system pressure and system flow rate. Sites with a high pressure typically use impulse turbines whereas high flow rate sites use reaction turbines.

Typical Efficiencies

The system efficiency is dependent on the turbine design, system flow and head pressure. Typical system efficiency is between 40% and 70% with the average efficiency being 55%.⁸⁷ Depending on the turbine design, variations in system flow and head pressure significantly affect the efficiency.

Useful Waste Heat Recovery

This does not apply for pressure reduction turbines.

Criteria Air Pollution Emissions

This does not apply for pressure reduction turbines.

⁸⁷ 2013 Regional Water Facilities Optimization and Master Plan Update. March 2014.



Generation Profiles and Ramp Rates

This generation technology allows a facility operator to generate electricity and offset on site load. .The generation is not intermittent and a recent survey by the California Renewable Energy Center revealed about 40% of the sites with in-conduit small hydro used all the power on-site.⁸⁸

Lifetime and Performance over Time

The typical turbine lifetime is 25 years.⁸⁹ A degradation factor of 2.0% is assumed in the cost effectiveness model based on small hydroelectric generation technology literature sources and CEC Renewable Technology Cost data.

Current Technology Capital Costs

88 California Renewable Energy Center, Public Workshop at the CEC, September 3, 2014

89 2013 Regional Water Facilities Optimization and Master Plan Update. March 2014.



Table A-23 summarizes the cost data developed for pressure reduction turbines of 400kW. The cost data are sourced from manufacturers,^{90,91} a water plant operator, and current literature.^{92,93} The experts we talked to indicated the costs tend to be highly variable because each site is custom-specific, and it depends if the turbine is also custom-made or uses off-the-shelf pumps as turbines. All costs are presented in 2013 dollars.

Current Technology Operating and Maintenance Costs

Table A-23 shows the O&M cost used in the cost effectiveness model. As previously discussed, these costs are highly variable and very site-specific with ranges reported between \$0.006 to \$0.105 per kWh.⁹⁴ We use a modal cost of \$0.010 per kWh as reported by a manufacturer.⁹⁵

90 Canyon Hydro. Personal Communication 2014.

91 Zeropex

92 2013 Regional Water Facilities optimization and Master Plan Update. March 2014

93 Recapturing Embedded Energy in Water Systems: A White Paper on In-Conduit Generation Issues and Policies. Lon W. House. 2012.

94 CEC Staff Workshop Building and Community Scale Renewable Technology Costs August 25, 2009

95 Zeropex



TABLE A-23: PRESSURE REDUCTION TURBINE COST ESTIMATES

	Cost Data
Average System Size (kW)	400
Electricity Generation System	
<i>Equipment</i>	1,875
<i>Labor</i>	
<i>Balance of Plant</i>	
<i>Additional Air Pollution Control</i>	-
<i>Other Costs</i>	2,100
System Cost per kW	4,054
Waste Heat Handling System (If Separate)	
<i>Equipment</i>	-
<i>Labor</i>	-
<i>Balance of Plant</i>	-
<i>Other Costs</i>	-
Waste Heat Handling Cost per Btu	-
	-
Biogas Capital Costs	
<i>Anaerobic Digester Gas Collection</i>	-
<i>Gas Clean Up</i>	-
<i>Other Costs</i>	-
Total Biogas Costs per kW	-
O&M Costs	
<i>Electrical</i>	0.010
<i>Biogas Capture</i>	-
<i>Biogas Clean Up</i>	-
<i>Air Pollution Control</i>	-
Total O&M Costs per kWh	0.010

Estimating Future Capital Costs

Pressure reduction turbines are a hydroelectric generation technology; thus there is a long history of development and implementation. In the case of pressure reduction turbine applications, there are few



manufacturers and the systems installed are relatively small (<500kW). We assume future capital costs based on learning curves would be flat with little opportunity to reduce cost through learning.

Technology Growth

A growth rate of 0% is assumed for estimating future installed capacity. None of the manufacturers we contacted were willing to share information on historical demand or projected sales. Therefore, we have no basis or supporting data to project growth trends.

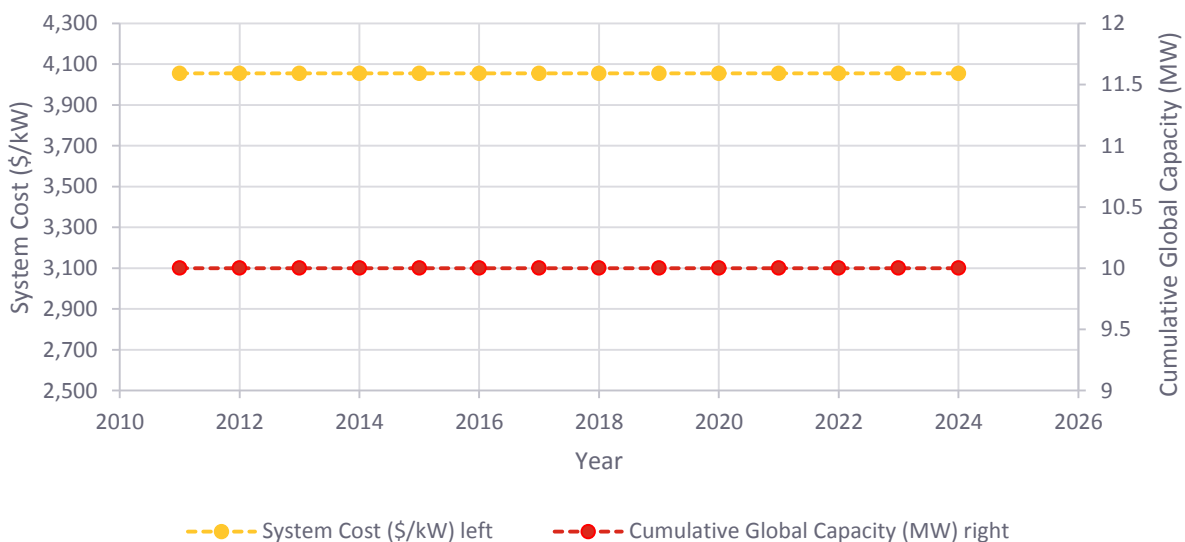
Developing Learning Curves

To develop learning curves we need to have historical installed capacity and cost data. These data are unavailable from the manufacturers we contacted and are not found in any literature sources. While cost data from individual operators who have installed pressure reduction turbines are available, they are not enough to develop the learning curves or progress ratio.

Projected Future Costs

Figure A-57 shows the projected future costs and cumulative global capacity used in the cost effectiveness model. These costs and capacities are based on assuming a progress ratio of 100% and a growth rate of 0%.

FIGURE A-57: PROJECTED FUTURE PRESSURE REDUCTION TURBINE COSTS & CUMULATIVE CAPACITY





A.10 TECHNOLOGY SUMMARY

Table A-24 summarizes the learning rates assumed for each technology.

TABLE A-24: LIST OF TECHNOLOGY LEARNING RATES AND PROGRESS RATIOS

Technology	Progress Ratio	Learning Rate
Fuel Cell	0.85	0.15
Gas Turbine – 2,500 kW	0.87	0.13
Gas Turbine – 7,000 kW	0.94	0.06
IC Engine < 500 kW	0.96	0.04
IC Engine – 1,500 kW	0.94	0.06
Microturbine	0.88	0.12
Organic Rankine Cycle	1.0	0.0
Wind – 50 kW	0.95	0.05
Wind – 1,500 kW	0.93	0.07
Storage	0.80	0.20
Pressure Reduction Turbine	1.0	0.0

APPENDIX B INVESTIGATED UTILITY-SCALE TECHNOLOGIES

B.1 INTRODUCTION

As a comparison to the SGIP technologies presented in Appendix A, Appendix B presents performance aspects, installed costs, and levelized cost of energy (LCOE) estimates for utility-scale generation resources. The central station technologies investigated in this report include two types of natural gas-fired generators: aeroderivative (simple cycle) combustion turbines (CTs) and combined cycle (CC) gas turbines. Cost and performance data for these technologies were derived through a thorough literature review of secondary sources, including reports from national labs, federal or state energy programs, and other energy research organizations. Because utility-scale technologies are not actually included in SGIPce model runs, learning curves and progress ratios were not developed. The installed costs and LCOE values presented here are meant only to serve as a comparison to the results of SGIPce model runs for the SGIP technologies.

B.2 AERODERIVATIVE COMBUSTION TURBINES (SIMPLE CYCLE)

This section provides a summary of the aeroderivative CT technology and describes the sources and analysis used to estimate capital costs, O&M costs, and LCOE figures.

Technology Summary

Aeroderivative CTs are so named because they are similar in design to large commercial airliner jet engines. These turbines are popular as peaking units because they provide fast ramping rates, which is highly desirable for grid stabilization for areas with high penetrations of intermittent renewable resources like solar and wind energy. Aeroderivative CTs are not the only type of simple cycle CTs. The alternate simple cycle turbine, called a “frame” design, is more similar to a standard steam turbine. While popular in other parts of the country, there have not been any frame design turbines developed in California recently. Instead, advanced aeroderivative CTs have become more popular in recent years due to their higher fuel efficiency, lower costs, and reduced emissions.¹

There are also two types of aeroderivative CTs: conventional and advanced design. Conventional CTs do not have the capacity to extract additional energy from exhaust gases, resulting in lower efficiencies than advanced CTs. Advanced CTs require additional cooling infrastructure to increase power output but have generally higher efficiencies. The interested reader can find a good overview of CTs in the 2014 CEC *Estimated Cost of New Renewable and Fossil Generation in California* report.² A summary of the CT operational characteristics used in the CEC report is included in Table B-1.

¹ <http://www.energy.ca.gov/2014publications/CEC-200-2014-003/CEC-200-2014-003-SD.pdf>

² Ibid.



TABLE B-1: AERODERIVATIVE COMBUSTION TURBINE PERFORMANCE CHARACTERISTICS

	Conventional CT—One LM6000 Turbine			Conventional CT—Two LM6000 Turbines			Advanced CT—Two LMS100 Turbines		
	Low	Mid	High	Low	Mid	High	Low	Mid	High
Gross Capacity	49.9 MW			100 MW			200 MW		
Typical Thermal Efficiency	42%*			42%*			44%*		
Ramp Rate	50+ MW/min*			50+ MW/min*			50+ MW/min*		
Estimated Capacity Factor (IOU)	1%			1%			2%		
Degradation Rate	0.011%			0.011%			0.016%		
Heat Rate (Btu/kWh, HHV)	9,980	10,585	11,890	9,980	10,585	11,890	9,600	9,880	10,200
Plant-side Losses	2.3%	3.4%	4.2%	2.3%	3.4%	4.2%	2.3%	3.4%	4.2%
CO ₂ (lb/MWh)	1,168	1,239	1,392	1,168	1,239	1,392	1,124	1,157	1,194
NO _x (lb/MWh)	0.279			0.279			0.099		
PM ₁₀ (lb/MWh)	0.134			0.134			0.062		

Source: CEC 2014³ *from GE product literature

Current Technology Capital Costs

Figure B-1 shows all of the capital cost data points gathered for aeroderivative CTs. Nearly all sources found suggested that aeroderivative turbines are becoming more common and are particularly well suited for peaking capacity and/or for balancing intermittent renewables due to the quick ramping, low heat rates, and relatively high efficiencies. The plot includes High, Med, and Low scenarios for 50 MW, 100 MW, and 200 MW aeroderivative units from the CEC *Estimated Cost of New Renewable and Fossil Generation in California* report.⁴ High and low scenarios are based on the 10th percentile and 90th percentile values for the evaluated projects. Also included in the plot are eight points from a recent E3 study.⁵ These points are based on actual project costs for aeroderivative units ranging from 46 to 301 MW. All costs have been normalized to overnight capital costs in nominal 2013 dollars and have been regionalized to be representative of California.⁶

Variability in actual project costs is high, as evidenced by the large ranges presented in the CEC report, where the 10th and 90th percentiles for each capacity vary by a factor of two to three. The CEC report (and common practice) assumes there are economies of scale for larger capacity units. In fact, the available data suggest strong support for economics of scale but on a qualified basis. Figure B-1 does

³ Ibid.

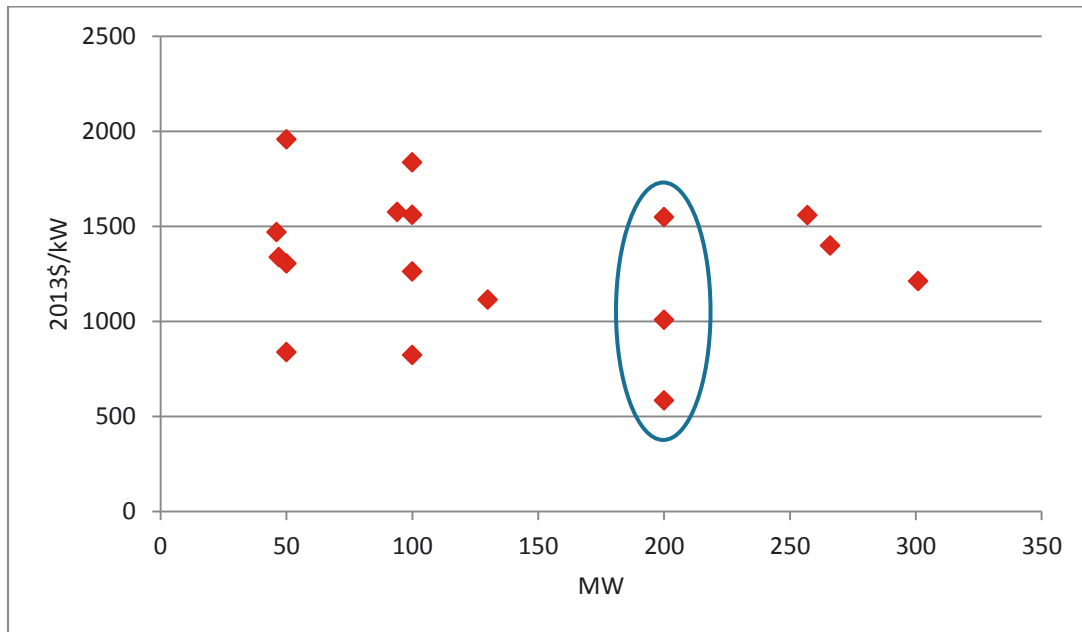
⁴ Ibid.

⁵ E3, 2012. *Cost and Performance Review of Generation Technologies – Recommendations for WECC 10- and 20-Year Study Process*. https://ethree.com/documents/E3_WECC_GenerationCostReport_23Oct2012.pdf

⁶ Ibid.

show some indication of a downward trend in \$/kW costs at higher capacities, but this is largely driven by the High, Med, and Low cost estimates for the 200 MW advanced CT from the CEC report (circled). However, even that report states, "The advanced CT case cost is based on very limited data for a different advanced gas turbine type. The significantly lower cost for the advanced CT case seems to overstate the potential for economy of scale reduction in cost, particularly since the LMS100 technology requires an increase in auxiliary equipment costs. Hence, there is a low level of confidence with the advanced CT costs."⁷

FIGURE B-1: AERODERIVATIVE COMBUSTION TURBINE INSTANT CAPITAL COSTS



Given the high variability in costs across the capacity range in question, the current analysis finds no clear case for differentiating the costs for 50, 100, and 200 MW aeroderivative simple cycle CTs. Table B-2 shows the equipment, labor, and materials cost breakdown for aeroderivative CTs recommended in this analysis. The figures were derived by taking a simple average of all 17 cost data points from the CEC and E3 studies (50–300 MW) to arrive at a total average overnight capital cost of \$1,316/kW. This value was broken down into equipment, labor, and balance of plant (BOP) costs using the E3 recommended component costs (35%, 50%, and 15%, respectively).

Current Technology Operating and Maintenance Costs

Similarly, Table B-2 contains an estimate of total O&M costs per kWh. O&M costs were taken from the E3 and CEC studies. The estimate included below is the simple average of the 17 data points from these

⁷ <http://www.energy.ca.gov/2014publications/CEC-200-2014-003/CEC-200-2014-003-SD.pdf>



two studies for fixed O&M (\$23.87/kW-year). Variable O&M was taken as the simple average from seven data points presented by E3 and does not include fuel expenses.⁸

TABLE B-2: AERODERIVATIVE COMBUSTION TURBINE COSTS

Aeroderivative CT (50 – 300 MW)	
	Cost Data (2013\$)
Electricity Generation System	
<i>Equipment</i>	\$461
<i>Labor</i>	\$658
<i>BOP</i>	\$197
Total System Cost per kW	\$1,316
Fixed O&M cost (\$/kW-year)	\$23.87
Variable O&M cost (\$/MWh)	\$4.47

Levelized Cost of Energy

The LCOE estimate for aeroderivative CTs presented here is drawn from the U.S. Department of Energy’s OpenEI Transparent Cost Database.⁹ Because the LCOE of a technology is dependent on a large number of factors (such as capital and O&M costs, discount rate, assumed lifetime, capacity factor, fuel cost, etc.), average LCOE values are not likely to represent real project conditions. The Transparent Cost Database contains five estimates of LCOE for natural gas CTs, which range from \$0.04 to \$0.20/kWh, with an average of \$0.11/kWh. These estimates were derived from three recent studies by the U.S. Energy Information Administration, Black and Veatch, and Lazard.¹⁰ The estimates assume a 30-year lifetime, a 10% to 30% capacity factor, a 7% discount rate, and a natural gas fuel cost of \$4.67/million Btu.

B.3 COMBINED CYCLE GAS TURBINES

This section provides a summary of the CC gas turbine technology and describes the sources and analysis used to estimate capital costs, O&M costs, and LCOE figures.

⁸ E3, 2012. *Cost and Performance Review of Generation Technologies – Recommendations for WECC 10- and 20-Year Study Process*. https://ethree.com/documents/E3_WECC_GenerationCostReport_23Oct2012.pdf

⁹ Transparent Cost Database, 2015. Open Energy Information (en). Accessed April, 15 2015: http://en.openei.org/wiki/Transparent_Cost_Database.

¹⁰ EIA, 2011. *Annual Energy Outlook* - [http://www.eia.gov/forecasts/aeo/pdf/0383\(2011\).pdf](http://www.eia.gov/forecasts/aeo/pdf/0383(2011).pdf)

Black and Veatch, 2012. *Cost and Performance Data for Power Generation Technologies*.

<http://bv.com/docs/reports-studies/nrel-cost-report.pdf>

Lazard, 2014. *Lazard Levelized Cost of Energy Analysis*, version 8.0.

<http://www.lazard.com/PDF/Levelized%20Cost%20of%20Energy%20-%20Version%208.0.pdf>



Technology Summary

CC generators use a frame design natural gas CT to directly generate electricity and also use the hot exhaust gases to create steam, which then turns an additional turbine to produce electricity. Combining a CT with a steam turbine serves to increase production and efficiency. However, this combination also typically leads to slower ramping speeds and less operational flexibility. CC power plants are further segregated into those units with duct firing and those without. Duct firing is the technique of adding additional natural gas-fired burners in the ducting, which adds additional heat to the exhaust gases used to create steam. Duct firing typically increases the output (e.g., for peaking capacity) of a CC turbine at the expense of overall efficiency.

There are some “advanced” CC turbines beginning to enter the market, such as the GE FlexEfficiency 50 CC power plants. The specifications for these units indicate that the high efficiency levels typical of CC units are maintained (60+ %) but are combined with much higher ramping rates than is typical of CCs (more than 50 MW/minute, which is nearly twice the typical value for combined cycle generators). Because these advanced designs are relatively new, reliable cost values were not available and are not represented in the technology costs presented below. A summary of the CC operational characteristics used in the CEC Cost of Generation report are included in Table B-3.

TABLE B-3: COMBINED CYCLE GAS TURBINE PERFORMANCE CHARACTERISTICS

	Conventional CC (no duct firing) — Two F-Class Turbines			Conventional CC (duct firing) — Two F-Class Turbines		
	Low	Mid	High	Low	Mid	High
Gross Capacity	500 MW			550 MW		
Typical Thermal Efficiency	58 – 60+%			50 – 60+%		
Ramp Rate	25 MW/min*			25 MW/min*		
Estimated Capacity Factor (IOU)	40%	57%	71%	40%	57%	71%
Degradation Rate	0.108%	0.178%	0.240%	0.108%	0.178%	0.240%
Heat Rate (Btu/kWh, HHV)	7,030	7,250	7,480	7,030	7,250	7,480
Plant-Side Losses	2.0%	2.9%	4.0%	2.0%	2.9%	4.0%
CO ₂ (lb/MWh)	823	849	876	823	849	876
NO _x (lb/MWh)	0.07			0.076		
PM ₁₀ (lb/MWh)	0.037			0.042		

Source: CEC 2014¹¹ * GE and Wärtsilä literature

¹¹ <http://www.energy.ca.gov/2014publications/CEC-200-2014-003/CEC-200-2014-003-SD.pdf>



Current Technology Capital Costs

The capital costs presented in Table B-4 are meant to approximate the cost of a prototypical 500 MW CC gas turbine. The values were derived by taking the simple average of five recent studies on the cost of electricity generation.¹² Normalized to nominal 2013\$, the instant capital costs presented in these studies range from \$1,011/kW to \$1,314/kW, with an average of \$1,200/kW. The total cost was then broken down into equipment (19%), labor (6%), BOP (58%), and other components (17%) using recommended values from Black and Veatch (2012).¹³

TABLE B-4: COMBINED CYCLE GAS TURBINE COSTS

Combined Cycle Gas Turbine (500 MW)	
	Cost Data (2013\$)
Electricity Generation System	
Equipment	\$228
Labor	\$72
BOP	\$696
Other	\$204
Total System Cost per kW	\$1,200
Fixed O&M cost (\$/kW-year)	\$9.30
Variable O&M cost (\$/MWh)	\$3.17

Current Technology Operating and Maintenance Costs

Fixed and variable operating and maintenance costs were taken from the same five sources as the capital costs. The nominal 2013\$ fixed costs per kW-year ranges from \$5.77/kW-year to \$15.00/kW-year, with an average of \$9.30/kW-year. Average variable O&M costs come to \$3.17/MWh (ranging from \$2.71 to \$5.34/MWh, excluding fuel).

¹² NREL, 2010. *Cost and Performance Assumptions for Modeling Electric Generation Technologies*.

<http://www.nrel.gov/docs/fy11osti/48595.pdf>

E3, 2012. *Cost and Performance Review of Generation Technologies – Recommendations for WECC 10- and 20-Year Study Process*. https://ethree.com/documents/E3_WECC_GenerationCostReport_23Oct2012.pdf

Black and Veatch, 2012. *Cost and Performance Data for Power Generation Technologies*.

<http://bv.com/docs/reports-studies/nrel-cost-report.pdf%E2%80%8E>

Lazard, 2014. *Lazard Levelized Cost of Energy Analysis*, version 8.0.

<http://www.lazard.com/PDF/Levelized%20Cost%20of%20Energy%20-%20Version%208.0.pdf>

E3, 2012. *Generation Capital Cost Recommendations for WECC 10- and 20-Year Studies*.

<http://www.docstoc.com/docs/156744534/Generation-Capital-Cost-Recommendations-for-WECC-10-Western>

¹³ Black and Veatch, 2012. *Cost and Performance Data for Power Generation Technologies*.

<http://bv.com/docs/reports-studies/nrel-cost-report.pdf%E2%80%8E>



Levelized Cost of Energy

The LCOE estimate for CC gas turbines presented here is drawn from the U.S. Department of Energy's OpenEI Transparent Cost Database.¹⁴ As noted above, the LCOE of a technology is dependent on a large number of factors (such as capital and O&M costs, discount rate, assumed lifetime, capacity factor, fuel cost, etc.) and average LCOE values are not likely to represent real project conditions. The Transparent Cost Database contains six estimates (from 2010 or later) of LCOE for natural gas CC turbines that range from \$0.02 to \$0.08/kWh, with an average of \$0.04/kWh. These estimates were derived from three recent studies by the U.S. Energy Information Administration, Black and Veatch, and Lazard.¹⁵ The estimates assume a 30-year lifetime, a 40% to 93% capacity factor, a 7% discount rate, and a natural gas fuel cost of \$4.67/million Btu.

¹⁴ Transparent Cost Database, 2015. Open Energy Information (en). Accessed April, 15 2015: http://en.openei.org/wiki/Transparent_Cost_Database.

¹⁵ EIA, 2011. *Annual Energy Outlook*. [http://www.eia.gov/forecasts/aeo/pdf/0383\(2011\).pdf](http://www.eia.gov/forecasts/aeo/pdf/0383(2011).pdf)

Black and Veatch, 2012. *Cost and Performance Data for Power Generation Technologies*.

<http://bv.com/docs/reports-studies/nrel-cost-report.pdf>

Lazard, 2014. *Lazard Levelized Cost of Energy Analysis*, version 8.0.

<http://www.lazard.com/PDF/Levelized%20Cost%20of%20Energy%20-%20Version%208.0.pdf>

APPENDIX C DETAILED MODIFIED INTERNAL RATE OF RETURN (MIRR) CHARTS

C.1 MIRR CHART LOCATION

The MIRR charts are in PDF format. Please see the PDF folder should you wish to review them.

- » ADVANCED ENERGY STORAGE
- » FUEL CELLS
- » PRESSURE REDUCTION TURBINES
- » ORGANIC RANKINE CYCLE
- » GAS TURBINES
- » IC ENGINES
- » MICROTURBINES
- » WIND



Advanced Energy Storage

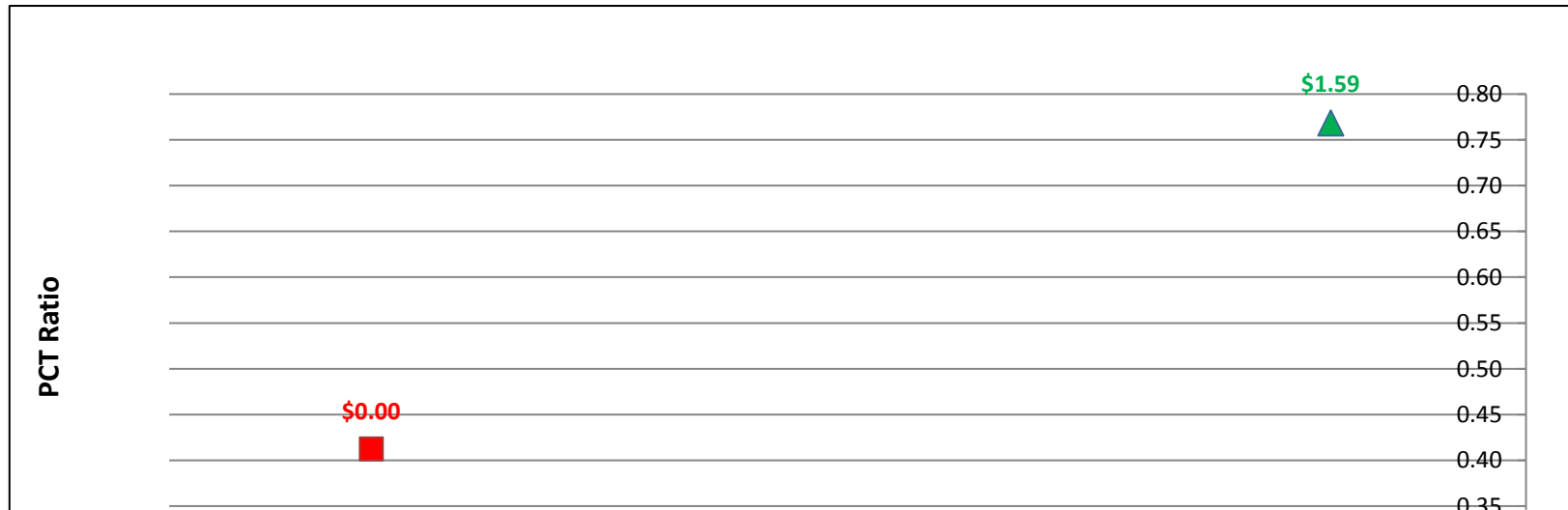


SGIP Cost Effectiveness Report
Participant Test Results (PCT)
MIRR Graphs

Storage30kW - Government/Non-Profit - PG&E

	Rebate (\$/watt)	MIRR	PCT-2014
▲ Actual Rebate - 2014	\$1.59	-10.3%	0.77
■ No Rebate	\$0.00	-16.7%	0.41
● Rebate to Reach MIRR of 5%	\$0.00	0.0%	0.00
● Rebate to Reach MIRR of 6%	\$0.00	0.0%	0.00
● Rebate to Reach MIRR of 7%	\$0.00	0.0%	0.00
● Rebate to Reach MIRR of 8%	\$0.00	0.0%	0.00
● Rebate to Reach MIRR of 9%	\$0.00	0.0%	0.00
● Rebate to Reach MIRR of 10%	\$0.00	0.0%	0.00
● Rebate to Reach MIRR of 11%	\$0.00	0.0%	0.00
● Rebate to Reach MIRR of 12%	\$0.00	0.0%	0.00
● Rebate to Reach MIRR of 13%	\$0.00	0.0%	0.00
● Rebate to Reach MIRR of 14%	\$0.00	0.0%	0.00
● Rebate to Reach MIRR of 15%	\$0.00	0.0%	0.00

System Cost per Watt: \$2.72

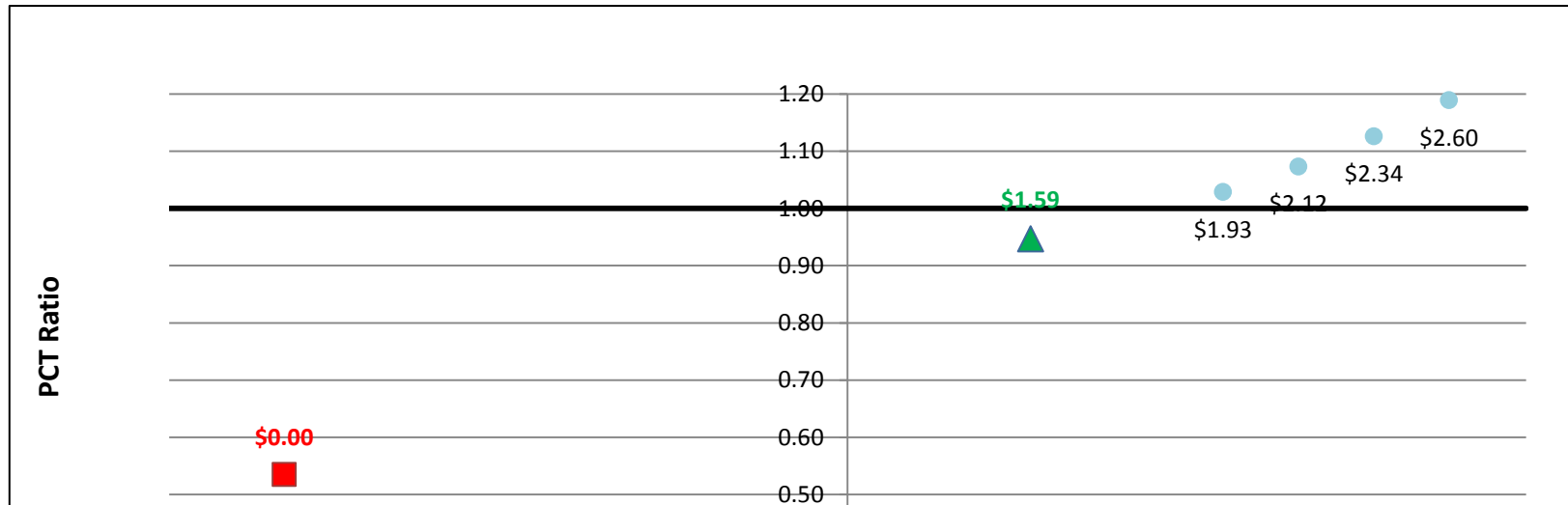


SGIP Cost Effectiveness Report
Participant Test Results (PCT)
MIRR Graphs

Storage30kW - Government/Non-Profit - SCE

	Rebate (\$/watt)	MIRR	PCT-2014
▲ Actual Rebate - 2014	\$1.59	2.4%	0.95
■ No Rebate	\$0.00	-7.5%	0.53
● Rebate to Reach MIRR of 5%	\$1.93	5.0%	1.03
● Rebate to Reach MIRR of 6%	\$2.12	6.0%	1.07
● Rebate to Reach MIRR of 7%	\$2.34	7.0%	1.13
● Rebate to Reach MIRR of 8%	\$2.60	8.0%	1.19
● Rebate to Reach MIRR of 9%	\$0.00	0.0%	0.00
● Rebate to Reach MIRR of 10%	\$0.00	0.0%	0.00
● Rebate to Reach MIRR of 11%	\$0.00	0.0%	0.00
● Rebate to Reach MIRR of 12%	\$0.00	0.0%	0.00
● Rebate to Reach MIRR of 13%	\$0.00	0.0%	0.00
● Rebate to Reach MIRR of 14%	\$0.00	0.0%	0.00
● Rebate to Reach MIRR of 15%	\$0.00	0.0%	0.00

System Cost per Watt: \$2.72

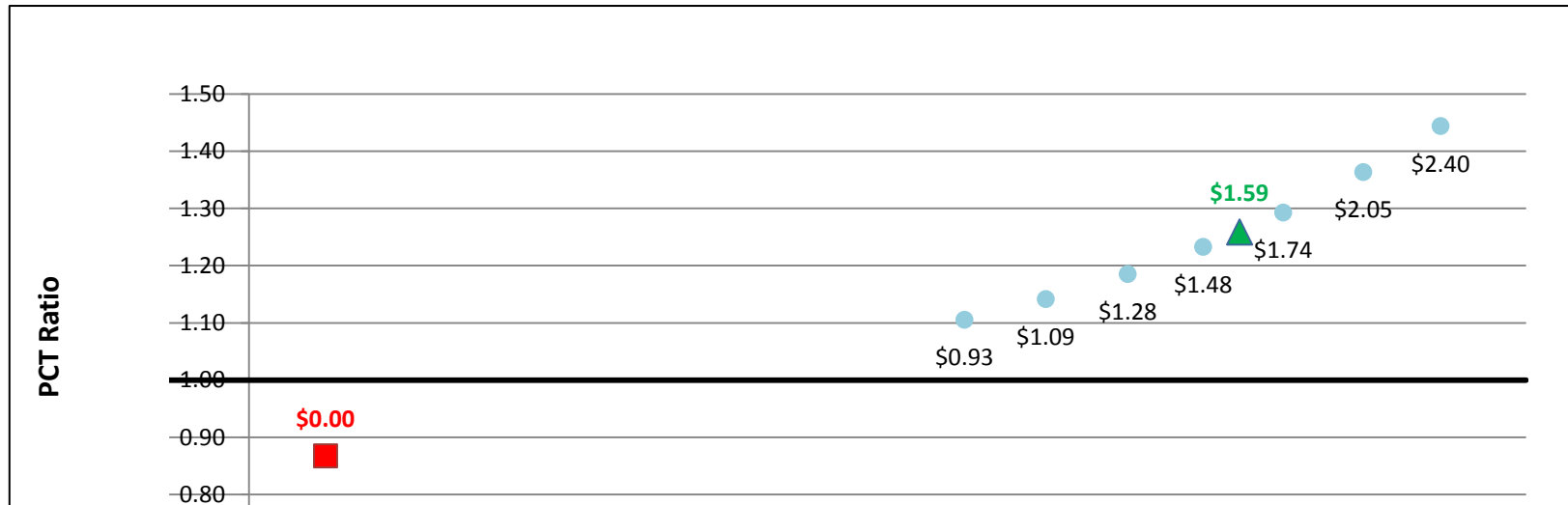


SGIP Cost Effectiveness Report
Participant Test Results (PCT)
MIRR Graphs

Storage30kW - Government/Non-Profit - SDG&E

	Rebate (\$/watt)	MIRR	PCT-2014
▲ Actual Rebate - 2014	\$1.59	12.4%	1.26
■ No Rebate	\$0.00	1.0%	0.87
● Rebate to Reach MIRR of 5%	\$0.00	0.0%	0.00
● Rebate to Reach MIRR of 6%	\$0.00	0.0%	0.00
● Rebate to Reach MIRR of 7%	\$0.00	0.0%	0.00
● Rebate to Reach MIRR of 8%	\$0.00	0.0%	0.00
● Rebate to Reach MIRR of 9%	\$0.93	9.0%	1.11
● Rebate to Reach MIRR of 10%	\$1.09	10.0%	1.14
● Rebate to Reach MIRR of 11%	\$1.28	11.0%	1.19
● Rebate to Reach MIRR of 12%	\$1.48	12.0%	1.23
● Rebate to Reach MIRR of 13%	\$1.74	13.0%	1.29
● Rebate to Reach MIRR of 14%	\$2.05	14.0%	1.36
● Rebate to Reach MIRR of 15%	\$2.40	14.9%	1.44

System Cost per Watt: \$2.72

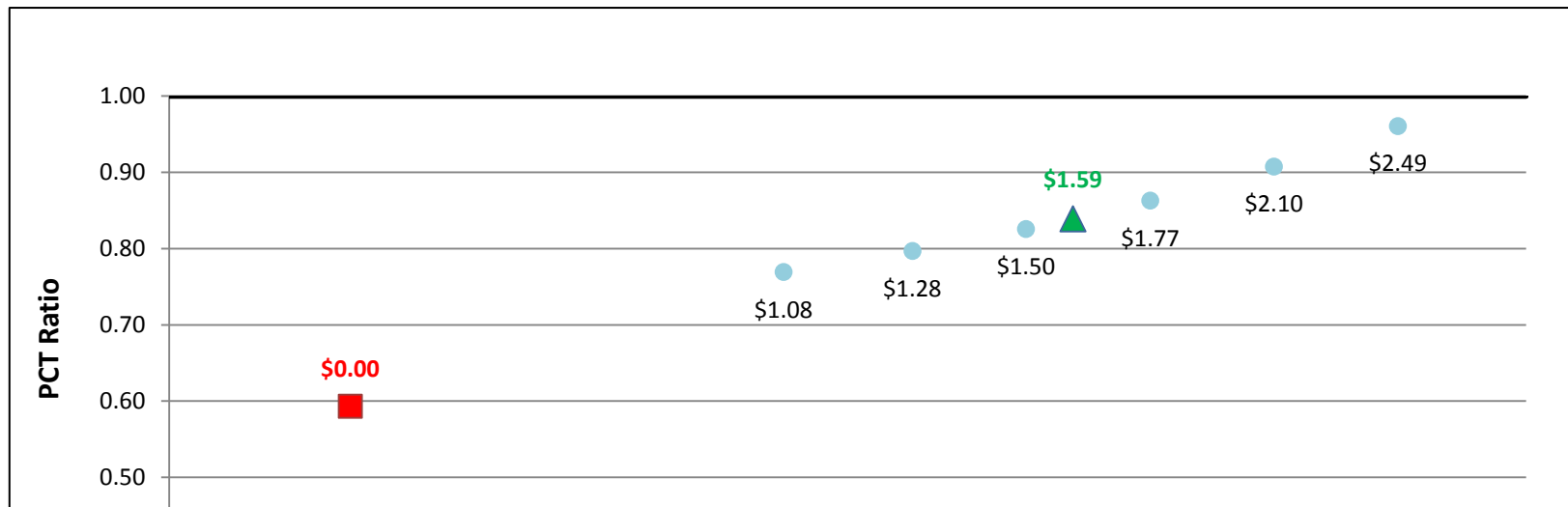


SGIP Cost Effectiveness Report
Participant Test Results (PCT)
MIRR Graphs

Storage30kW - Commercial - PG&E

	Rebate (\$/watt)	MIRR	PCT-2014
▲ Actual Rebate - 2014	\$1.59	7.3%	0.84
■ No Rebate	\$0.00	1.5%	0.59
● Rebate to Reach MIRR of 5%	\$1.08	5.0%	0.77
● Rebate to Reach MIRR of 6%	\$1.28	6.0%	0.80
● Rebate to Reach MIRR of 7%	\$1.50	6.9%	0.83
● Rebate to Reach MIRR of 8%	\$1.77	8.0%	0.86
● Rebate to Reach MIRR of 9%	\$2.10	9.0%	0.91
● Rebate to Reach MIRR of 10%	\$2.49	10.0%	0.96
● Rebate to Reach MIRR of 11%	\$0.00	0.0%	0.00
● Rebate to Reach MIRR of 12%	\$0.00	0.0%	0.00
● Rebate to Reach MIRR of 13%	\$0.00	0.0%	0.00
● Rebate to Reach MIRR of 14%	\$0.00	0.0%	0.00
● Rebate to Reach MIRR of 15%	\$0.00	0.0%	0.00

System Cost per Watt: \$2.72

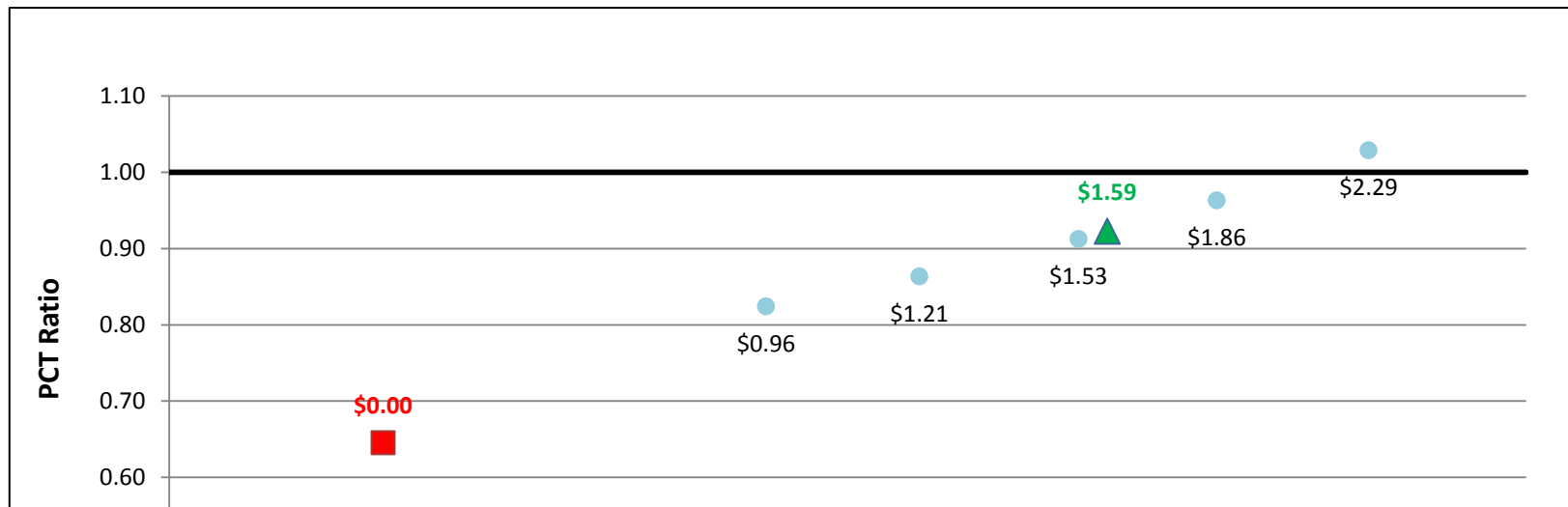


SGIP Cost Effectiveness Report
Participant Test Results (PCT)
MIRR Graphs

Storage30kW - Commercial - SCE

	Rebate (\$/watt)	MIRR	PCT-2014
▲ Actual Rebate - 2014	\$1.59	9.2%	0.92
■ No Rebate	\$0.00	4.4%	0.64
● Rebate to Reach MIRR of 5%	\$0.00	0.0%	0.00
● Rebate to Reach MIRR of 6%	\$0.00	0.0%	0.00
● Rebate to Reach MIRR of 7%	\$0.96	7.0%	0.82
● Rebate to Reach MIRR of 8%	\$1.21	8.0%	0.86
● Rebate to Reach MIRR of 9%	\$1.53	9.0%	0.91
● Rebate to Reach MIRR of 10%	\$1.86	9.9%	0.96
● Rebate to Reach MIRR of 11%	\$2.29	11.0%	1.03
● Rebate to Reach MIRR of 12%	\$0.00	0.0%	0.00
● Rebate to Reach MIRR of 13%	\$0.00	0.0%	0.00
● Rebate to Reach MIRR of 14%	\$0.00	0.0%	0.00
● Rebate to Reach MIRR of 15%	\$0.00	0.0%	0.00

System Cost per Watt: \$2.72

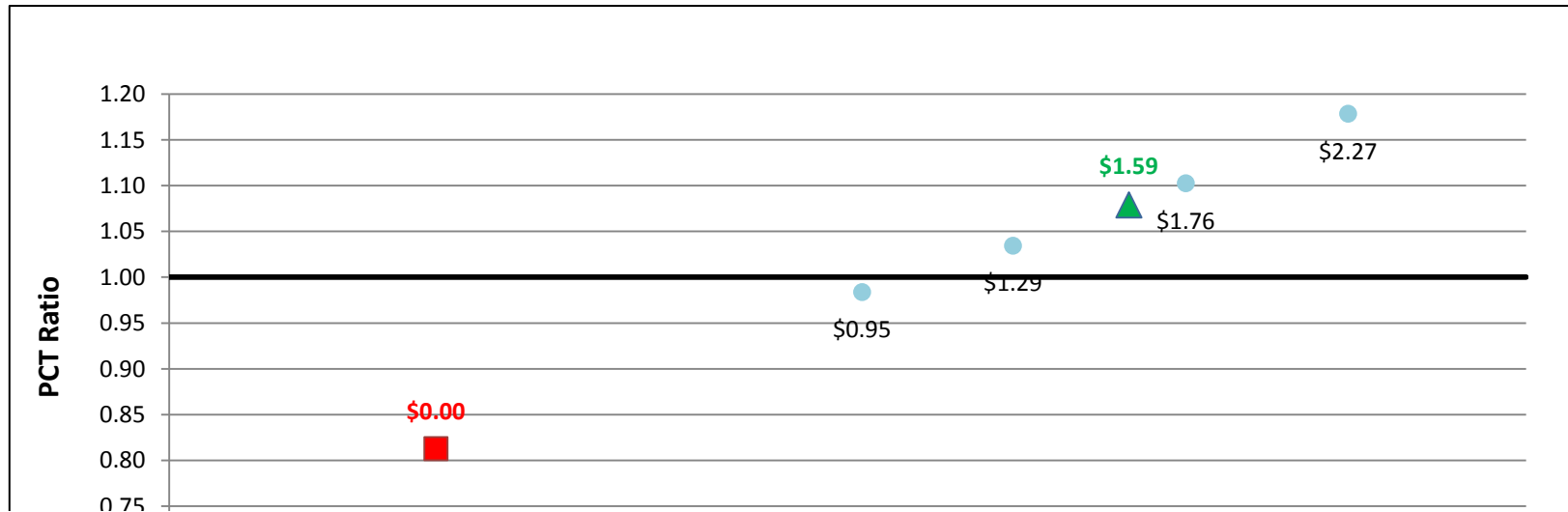


SGIP Cost Effectiveness Report
Participant Test Results (PCT)
MIRR Graphs

Storage30kW - Commercial - SDG&E

	Rebate (\$/watt)	MIRR	PCT-2014
▲ Actual Rebate - 2014	\$1.59	11.7%	1.08
■ No Rebate	\$0.00	7.6%	0.81
● Rebate to Reach MIRR of 5%	\$0.00	0.0%	0.00
● Rebate to Reach MIRR of 6%	\$0.00	0.0%	0.00
● Rebate to Reach MIRR of 7%	\$0.00	0.0%	0.00
● Rebate to Reach MIRR of 8%	\$0.00	0.0%	0.00
● Rebate to Reach MIRR of 9%	\$0.00	0.0%	0.00
● Rebate to Reach MIRR of 10%	\$0.95	10.1%	0.98
● Rebate to Reach MIRR of 11%	\$1.29	11.0%	1.03
● Rebate to Reach MIRR of 12%	\$1.76	12.0%	1.10
● Rebate to Reach MIRR of 13%	\$2.27	12.9%	1.18
● Rebate to Reach MIRR of 14%	\$0.00	0.0%	0.00
● Rebate to Reach MIRR of 15%	\$0.00	0.0%	0.00

System Cost per Watt: \$2.72



SGIP Cost Effectiveness Report
Participant Test Results (PCT)
MIRR Graphs

Storage5kW - Residential - PG&E

	Rebate (\$/watt)	MIRR	PCT-2014
▲ Actual Rebate - 2014	\$1.62	-9.8%	0.67
■ No Rebate	\$0.00	-100.0%	0.42
● Rebate to Reach MIRR of 5%	\$0.00	0.0%	0.00
● Rebate to Reach MIRR of 6%	\$0.00	0.0%	0.00
● Rebate to Reach MIRR of 7%	\$0.00	0.0%	0.00
● Rebate to Reach MIRR of 8%	\$0.00	0.0%	0.00
● Rebate to Reach MIRR of 9%	\$0.00	0.0%	0.00
● Rebate to Reach MIRR of 10%	\$0.00	0.0%	0.00
● Rebate to Reach MIRR of 11%	\$0.00	0.0%	0.00
● Rebate to Reach MIRR of 12%	\$0.00	0.0%	0.00
● Rebate to Reach MIRR of 13%	\$0.00	0.0%	0.00
● Rebate to Reach MIRR of 14%	\$0.00	0.0%	0.00
● Rebate to Reach MIRR of 15%	\$0.00	0.0%	0.00

System Cost per Watt: \$2.72



SGIP Cost Effectiveness Report
Participant Test Results (PCT)
MIRR Graphs

Storage5kW - Residential - SCE

	Rebate (\$/watt)	MIRR	PCT-2014
▲ Actual Rebate - 2014	\$1.62	-9.8%	0.67
■ No Rebate	\$0.00	-100.0%	0.42
● Rebate to Reach MIRR of 5%	\$0.00	0.0%	0.00
● Rebate to Reach MIRR of 6%	\$0.00	0.0%	0.00
● Rebate to Reach MIRR of 7%	\$0.00	0.0%	0.00
● Rebate to Reach MIRR of 8%	\$0.00	0.0%	0.00
● Rebate to Reach MIRR of 9%	\$0.00	0.0%	0.00
● Rebate to Reach MIRR of 10%	\$0.00	0.0%	0.00
● Rebate to Reach MIRR of 11%	\$0.00	0.0%	0.00
● Rebate to Reach MIRR of 12%	\$0.00	0.0%	0.00
● Rebate to Reach MIRR of 13%	\$0.00	0.0%	0.00
● Rebate to Reach MIRR of 14%	\$0.00	0.0%	0.00
● Rebate to Reach MIRR of 15%	\$0.00	0.0%	0.00

System Cost per Watt: \$2.72



SGIP Cost Effectiveness Report
 Participant Test Results (PCT)
 MIRR Graphs

Storage5kW - Residential - SDG&E

	Rebate (\$/watt)	MIRR	PCT-2014
▲ Actual Rebate - 2014	\$1.62	-9.4%	0.70
■ No Rebate	\$0.00	-100.0%	0.44
● Rebate to Reach MIRR of 5%	\$0.00	0.0%	0.00
● Rebate to Reach MIRR of 6%	\$0.00	0.0%	0.00
● Rebate to Reach MIRR of 7%	\$0.00	0.0%	0.00
● Rebate to Reach MIRR of 8%	\$0.00	0.0%	0.00
● Rebate to Reach MIRR of 9%	\$0.00	0.0%	0.00
● Rebate to Reach MIRR of 10%	\$0.00	0.0%	0.00
● Rebate to Reach MIRR of 11%	\$0.00	0.0%	0.00
● Rebate to Reach MIRR of 12%	\$0.00	0.0%	0.00
● Rebate to Reach MIRR of 13%	\$0.00	0.0%	0.00
● Rebate to Reach MIRR of 14%	\$0.00	0.0%	0.00
● Rebate to Reach MIRR of 15%	\$0.00	0.0%	0.00

System Cost per Watt: \$2.72



SGIP Cost Effectiveness Report
Participant Test Results (PCT)
MIRR Graphs

Storage5MW - Government/Non-Profit - PG&E

	Rebate (\$/watt)	MIRR	PCT-2014
▲ Actual Rebate - 2014	\$0.56	-100.0%	0.48
■ No Rebate	\$0.00	-100.0%	0.38
● Rebate to Reach MIRR of 5%	\$0.00	0.0%	0.00
● Rebate to Reach MIRR of 6%	\$0.00	0.0%	0.00
● Rebate to Reach MIRR of 7%	\$0.00	0.0%	0.00
● Rebate to Reach MIRR of 8%	\$0.00	0.0%	0.00
● Rebate to Reach MIRR of 9%	\$0.00	0.0%	0.00
● Rebate to Reach MIRR of 10%	\$0.00	0.0%	0.00
● Rebate to Reach MIRR of 11%	\$0.00	0.0%	0.00
● Rebate to Reach MIRR of 12%	\$0.00	0.0%	0.00
● Rebate to Reach MIRR of 13%	\$0.00	0.0%	0.00
● Rebate to Reach MIRR of 14%	\$0.00	0.0%	0.00
● Rebate to Reach MIRR of 15%	\$0.00	0.0%	0.00

System Cost per Watt: \$2.76

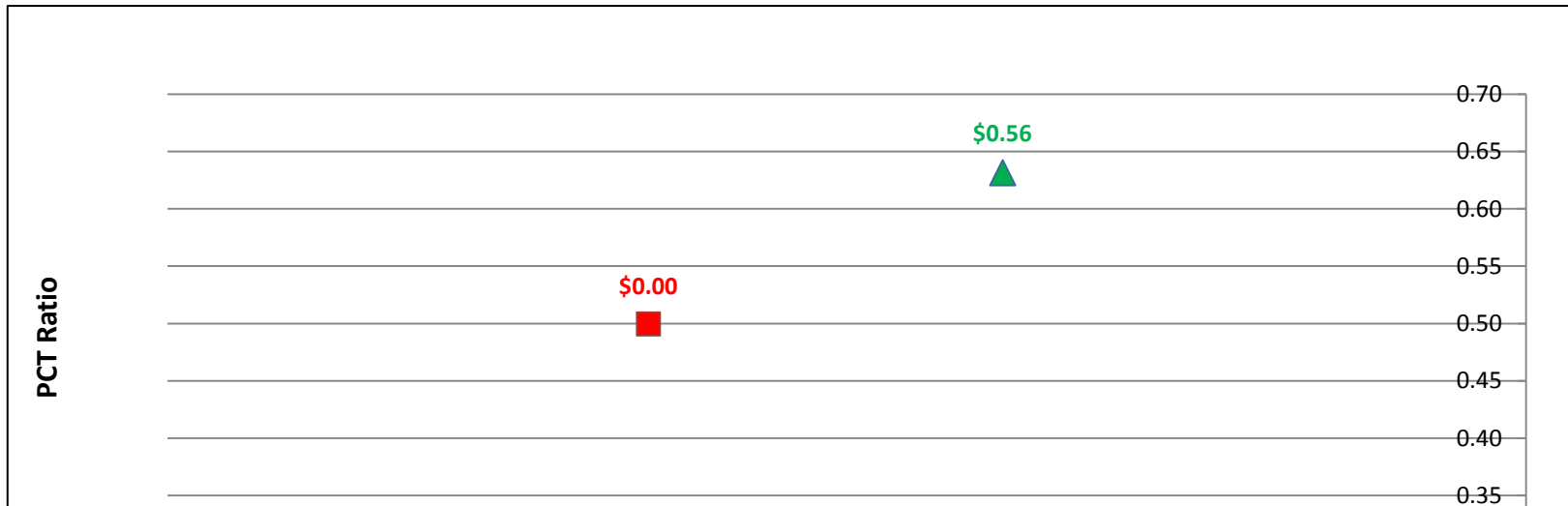


SGIP Cost Effectiveness Report
 Participant Test Results (PCT)
 MIRR Graphs

Storage5MW - Government/Non-Profit - SCE

	Rebate (\$/watt)	MIRR	PCT-2014
▲ Actual Rebate - 2014	\$0.56	-8.9%	0.63
■ No Rebate	\$0.00	-10.2%	0.50
● Rebate to Reach MIRR of 5%	\$0.00	0.0%	0.00
● Rebate to Reach MIRR of 6%	\$0.00	0.0%	0.00
● Rebate to Reach MIRR of 7%	\$0.00	0.0%	0.00
● Rebate to Reach MIRR of 8%	\$0.00	0.0%	0.00
● Rebate to Reach MIRR of 9%	\$0.00	0.0%	0.00
● Rebate to Reach MIRR of 10%	\$0.00	0.0%	0.00
● Rebate to Reach MIRR of 11%	\$0.00	0.0%	0.00
● Rebate to Reach MIRR of 12%	\$0.00	0.0%	0.00
● Rebate to Reach MIRR of 13%	\$0.00	0.0%	0.00
● Rebate to Reach MIRR of 14%	\$0.00	0.0%	0.00
● Rebate to Reach MIRR of 15%	\$0.00	0.0%	0.00

System Cost per Watt: \$2.76

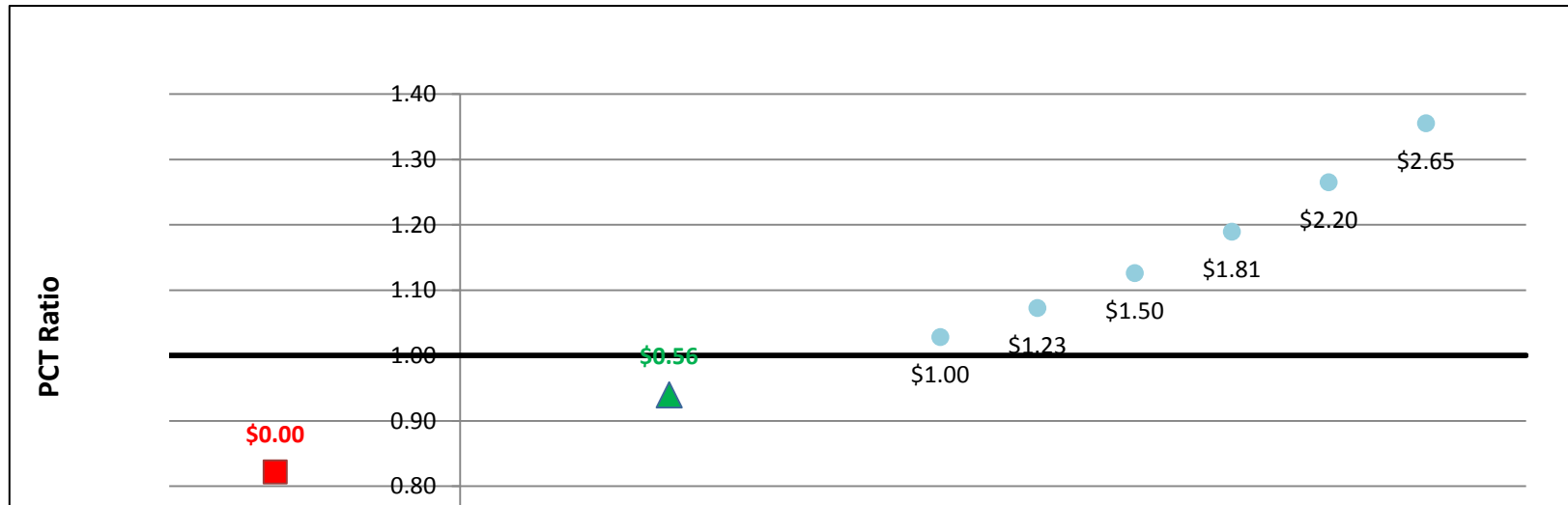


SGIP Cost Effectiveness Report
Participant Test Results (PCT)
MIRR Graphs

Storage5MW - Government/Non-Profit - SDG&E

	Rebate (\$/watt)	MIRR	PCT-2014
▲ Actual Rebate - 2014	\$0.56	2.2%	0.94
■ No Rebate	\$0.00	-1.9%	0.82
● Rebate to Reach MIRR of 5%	\$1.00	5.0%	1.03
● Rebate to Reach MIRR of 6%	\$1.23	6.0%	1.07
● Rebate to Reach MIRR of 7%	\$1.50	7.0%	1.13
● Rebate to Reach MIRR of 8%	\$1.81	8.0%	1.19
● Rebate to Reach MIRR of 9%	\$2.20	9.0%	1.26
● Rebate to Reach MIRR of 10%	\$2.65	10.0%	1.35
● Rebate to Reach MIRR of 11%	\$0.00	0.0%	0.00
● Rebate to Reach MIRR of 12%	\$0.00	0.0%	0.00
● Rebate to Reach MIRR of 13%	\$0.00	0.0%	0.00
● Rebate to Reach MIRR of 14%	\$0.00	0.0%	0.00
● Rebate to Reach MIRR of 15%	\$0.00	0.0%	0.00

System Cost per Watt: \$2.76

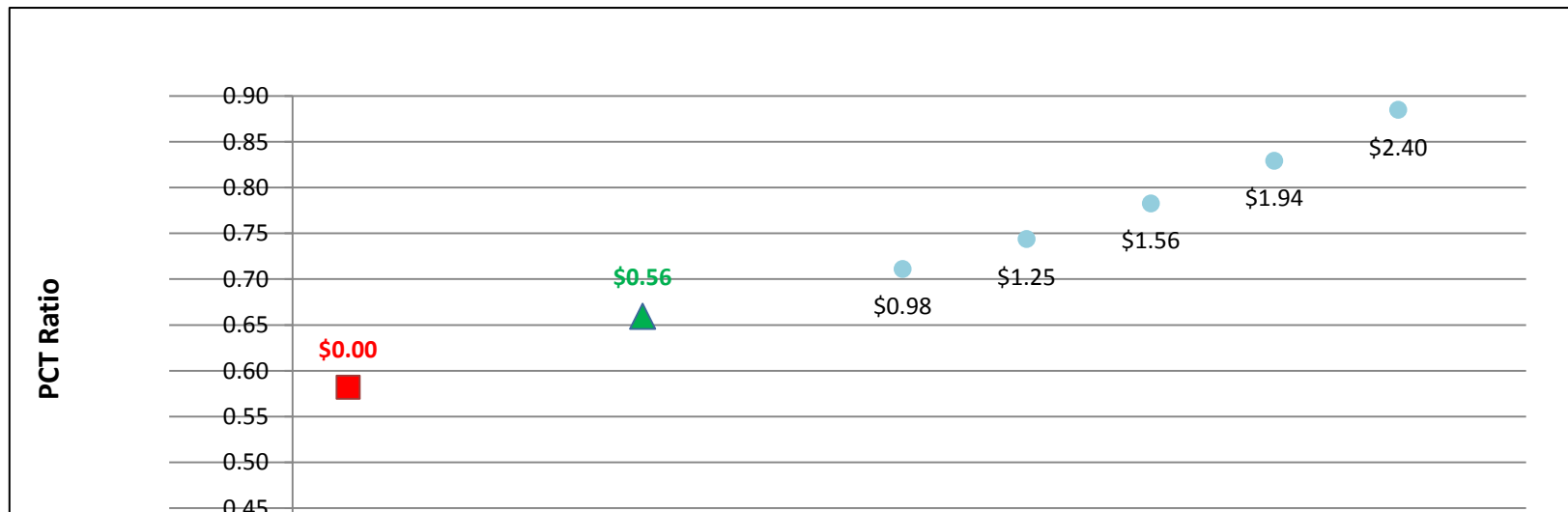


SGIP Cost Effectiveness Report
Participant Test Results (PCT)
MIRR Graphs

Storage5MW - Commercial - PG&E

	Rebate (\$/watt)	MIRR	PCT-2014
▲ Actual Rebate - 2014	\$0.56	2.8%	0.66
■ No Rebate	\$0.00	0.5%	0.58
● Rebate to Reach MIRR of 5%	\$0.98	4.9%	0.71
● Rebate to Reach MIRR of 6%	\$1.25	5.9%	0.74
● Rebate to Reach MIRR of 7%	\$1.56	7.0%	0.78
● Rebate to Reach MIRR of 8%	\$1.94	8.0%	0.83
● Rebate to Reach MIRR of 9%	\$2.40	9.0%	0.88
● Rebate to Reach MIRR of 10%	\$0.00	0.0%	0.00
● Rebate to Reach MIRR of 11%	\$0.00	0.0%	0.00
● Rebate to Reach MIRR of 12%	\$0.00	0.0%	0.00
● Rebate to Reach MIRR of 13%	\$0.00	0.0%	0.00
● Rebate to Reach MIRR of 14%	\$0.00	0.0%	0.00
● Rebate to Reach MIRR of 15%	\$0.00	0.0%	0.00

System Cost per Watt: \$2.76

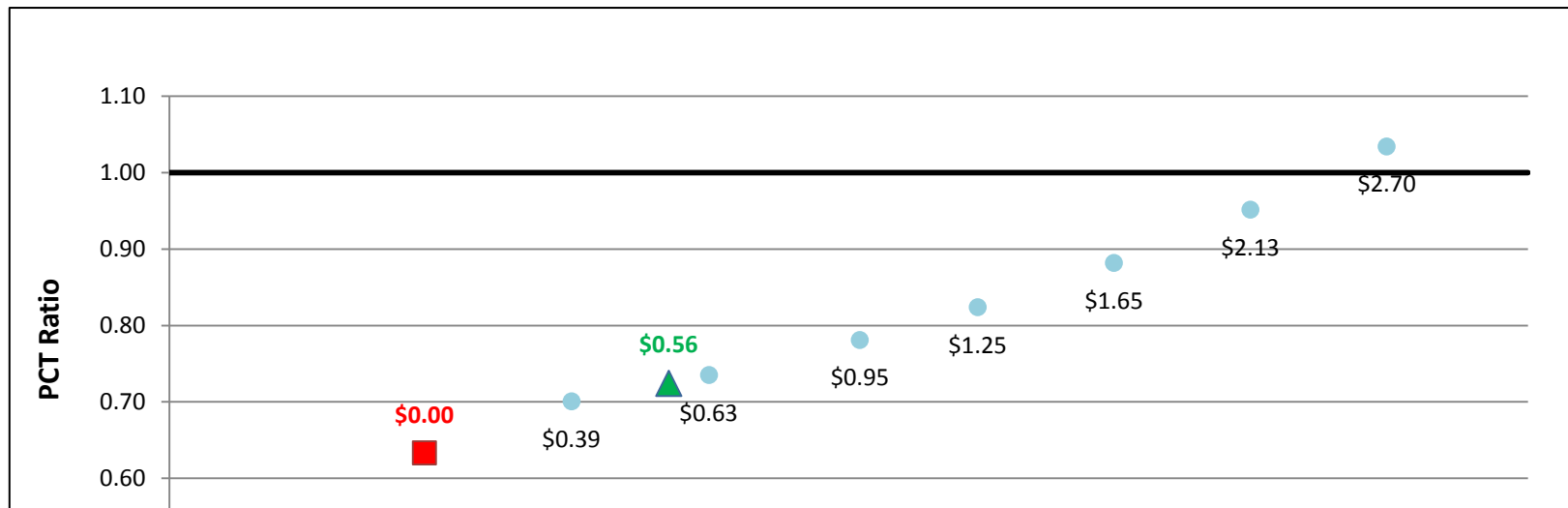


SGIP Cost Effectiveness Report
Participant Test Results (PCT)
MIRR Graphs

Storage5MW - Commercial - SCE

	Rebate (\$/watt)	MIRR	PCT-2014
▲ Actual Rebate - 2014	\$0.56	5.7%	0.72
■ No Rebate	\$0.00	3.9%	0.63
● Rebate to Reach MIRR of 5%	\$0.39	5.0%	0.70
● Rebate to Reach MIRR of 6%	\$0.63	6.0%	0.73
● Rebate to Reach MIRR of 7%	\$0.95	7.1%	0.78
● Rebate to Reach MIRR of 8%	\$1.25	7.9%	0.82
● Rebate to Reach MIRR of 9%	\$1.65	9.0%	0.88
● Rebate to Reach MIRR of 10%	\$2.13	10.0%	0.95
● Rebate to Reach MIRR of 11%	\$2.70	11.0%	1.03
● Rebate to Reach MIRR of 12%	\$0.00	0.0%	0.00
● Rebate to Reach MIRR of 13%	\$0.00	0.0%	0.00
● Rebate to Reach MIRR of 14%	\$0.00	0.0%	0.00
● Rebate to Reach MIRR of 15%	\$0.00	0.0%	0.00

System Cost per Watt: \$2.76

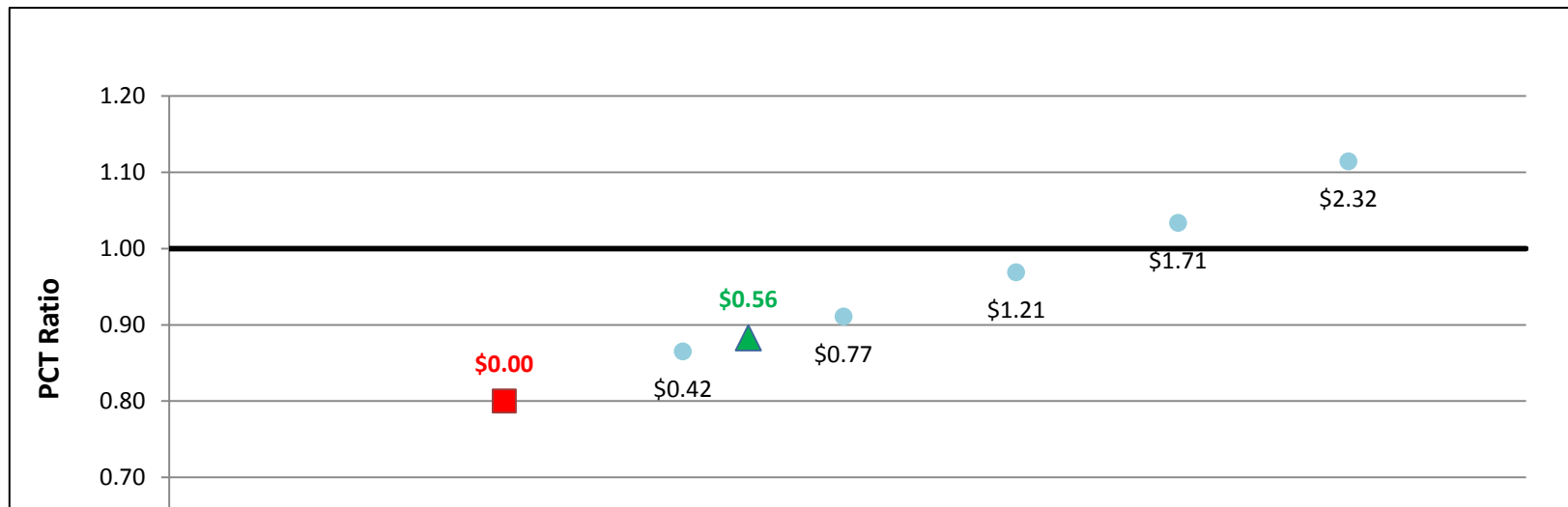


SGIP Cost Effectiveness Report
Participant Test Results (PCT)
MIRR Graphs

Storage5MW - Commercial - SDG&E

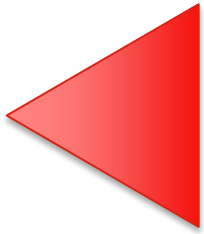
	Rebate (\$/watt)	MIRR	PCT-2014
▲ Actual Rebate - 2014	\$0.56	8.4%	0.88
■ No Rebate	\$0.00	7.0%	0.80
● Rebate to Reach MIRR of 5%	\$0.00	0.0%	0.00
● Rebate to Reach MIRR of 6%	\$0.00	0.0%	0.00
● Rebate to Reach MIRR of 7%	\$0.00	0.0%	0.00
● Rebate to Reach MIRR of 8%	\$0.42	8.0%	0.86
● Rebate to Reach MIRR of 9%	\$0.77	9.0%	0.91
● Rebate to Reach MIRR of 10%	\$1.21	10.0%	0.97
● Rebate to Reach MIRR of 11%	\$1.71	10.9%	1.03
● Rebate to Reach MIRR of 12%	\$2.32	12.0%	1.11
● Rebate to Reach MIRR of 13%	\$0.00	0.0%	0.00
● Rebate to Reach MIRR of 14%	\$0.00	0.0%	0.00
● Rebate to Reach MIRR of 15%	\$0.00	0.0%	0.00

System Cost per Watt: \$2.76





Fuel Cells



SGIP Cost Effectiveness Report
Participant Test Results (PCT)
MIRR Graphs

FC1200kW w/ Directed BioGas - Government/Non-Profit - PG&E

	Rebate (\$/watt)	MIRR	PCT-2014
▲ Actual Rebate - 2014	\$3.01	-15.0%	0.74
■ No Rebate	\$0.00	-100.0%	0.62
● Rebate to Reach MIRR of 5%	\$0.00	0.0%	0.00
● Rebate to Reach MIRR of 6%	\$0.00	0.0%	0.00
● Rebate to Reach MIRR of 7%	\$0.00	0.0%	0.00
● Rebate to Reach MIRR of 8%	\$0.00	0.0%	0.00
● Rebate to Reach MIRR of 9%	\$0.00	0.0%	0.00
● Rebate to Reach MIRR of 10%	\$0.00	0.0%	0.00
● Rebate to Reach MIRR of 11%	\$0.00	0.0%	0.00
● Rebate to Reach MIRR of 12%	\$0.00	0.0%	0.00
● Rebate to Reach MIRR of 13%	\$0.00	0.0%	0.00
● Rebate to Reach MIRR of 14%	\$0.00	0.0%	0.00
● Rebate to Reach MIRR of 15%	\$0.00	0.0%	0.00

System Cost per Watt: \$4.37



SGIP Cost Effectiveness Report
Participant Test Results (PCT)
MIRR Graphs

FC1200kW w/ Directed BioGas - Government/Non-Profit - SCE

	Rebate (\$/watt)	MIRR	PCT-2014
▲ Actual Rebate - 2014	\$3.01	-100.0%	0.55
■ No Rebate	\$0.00	-100.0%	0.42
● Rebate to Reach MIRR of 5%	\$0.00	0.0%	0.00
● Rebate to Reach MIRR of 6%	\$0.00	0.0%	0.00
● Rebate to Reach MIRR of 7%	\$0.00	0.0%	0.00
● Rebate to Reach MIRR of 8%	\$0.00	0.0%	0.00
● Rebate to Reach MIRR of 9%	\$0.00	0.0%	0.00
● Rebate to Reach MIRR of 10%	\$0.00	0.0%	0.00
● Rebate to Reach MIRR of 11%	\$0.00	0.0%	0.00
● Rebate to Reach MIRR of 12%	\$0.00	0.0%	0.00
● Rebate to Reach MIRR of 13%	\$0.00	0.0%	0.00
● Rebate to Reach MIRR of 14%	\$0.00	0.0%	0.00
● Rebate to Reach MIRR of 15%	\$0.00	0.0%	0.00

System Cost per Watt: \$4.37



SGIP Cost Effectiveness Report
Participant Test Results (PCT)
MIRR Graphs

FC1200kW w/ Directed BioGas - Government/Non-Profit - SDG&E

	Rebate (\$/watt)	MIRR	PCT-2014
▲ Actual Rebate - 2014	\$3.01	-100.0%	0.66
■ No Rebate	\$0.00	-100.0%	0.54
● Rebate to Reach MIRR of 5%	\$0.00	0.0%	0.00
● Rebate to Reach MIRR of 6%	\$0.00	0.0%	0.00
● Rebate to Reach MIRR of 7%	\$0.00	0.0%	0.00
● Rebate to Reach MIRR of 8%	\$0.00	0.0%	0.00
● Rebate to Reach MIRR of 9%	\$0.00	0.0%	0.00
● Rebate to Reach MIRR of 10%	\$0.00	0.0%	0.00
● Rebate to Reach MIRR of 11%	\$0.00	0.0%	0.00
● Rebate to Reach MIRR of 12%	\$0.00	0.0%	0.00
● Rebate to Reach MIRR of 13%	\$0.00	0.0%	0.00
● Rebate to Reach MIRR of 14%	\$0.00	0.0%	0.00
● Rebate to Reach MIRR of 15%	\$0.00	0.0%	0.00

System Cost per Watt: \$4.37

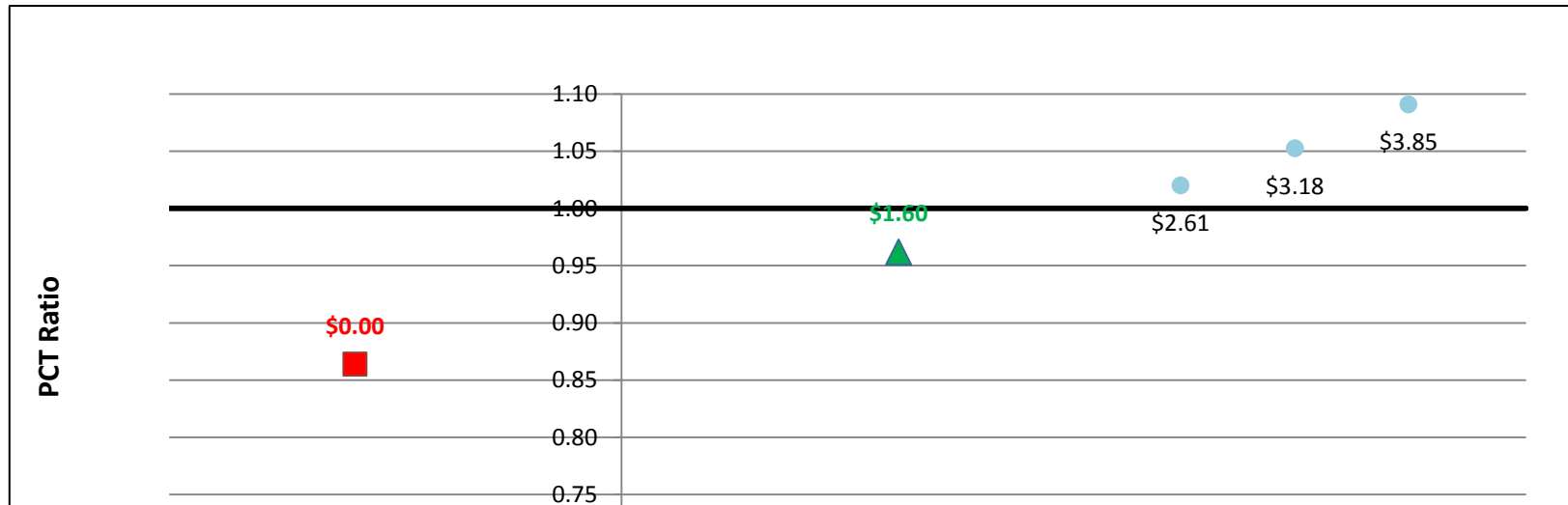


SGIP Cost Effectiveness Report
Participant Test Results (PCT)
MIRR Graphs

FC1200kW w/ Natural Gas - Government/Non-Profit - PG&E

	Rebate (\$/watt)	MIRR	PCT-2014
▲ Actual Rebate - 2014	\$1.60	2.5%	0.96
■ No Rebate	\$0.00	-2.4%	0.86
● Rebate to Reach MIRR of 5%	\$2.61	4.9%	1.02
● Rebate to Reach MIRR of 6%	\$3.18	6.0%	1.05
● Rebate to Reach MIRR of 7%	\$3.85	7.0%	1.09
● Rebate to Reach MIRR of 8%	\$0.00	0.0%	0.00
● Rebate to Reach MIRR of 9%	\$0.00	0.0%	0.00
● Rebate to Reach MIRR of 10%	\$0.00	0.0%	0.00
● Rebate to Reach MIRR of 11%	\$0.00	0.0%	0.00
● Rebate to Reach MIRR of 12%	\$0.00	0.0%	0.00
● Rebate to Reach MIRR of 13%	\$0.00	0.0%	0.00
● Rebate to Reach MIRR of 14%	\$0.00	0.0%	0.00
● Rebate to Reach MIRR of 15%	\$0.00	0.0%	0.00

System Cost per Watt: \$4.37



SGIP Cost Effectiveness Report
Participant Test Results (PCT)
MIRR Graphs

FC1200kW w/ Natural Gas - Government/Non-Profit - SCE

	Rebate (\$/watt)	MIRR	PCT-2014
▲ Actual Rebate - 2014	\$1.60	-100.0%	0.66
■ No Rebate	\$0.00	-100.0%	0.56
● Rebate to Reach MIRR of 5%	\$0.00	0.0%	0.00
● Rebate to Reach MIRR of 6%	\$0.00	0.0%	0.00
● Rebate to Reach MIRR of 7%	\$0.00	0.0%	0.00
● Rebate to Reach MIRR of 8%	\$0.00	0.0%	0.00
● Rebate to Reach MIRR of 9%	\$0.00	0.0%	0.00
● Rebate to Reach MIRR of 10%	\$0.00	0.0%	0.00
● Rebate to Reach MIRR of 11%	\$0.00	0.0%	0.00
● Rebate to Reach MIRR of 12%	\$0.00	0.0%	0.00
● Rebate to Reach MIRR of 13%	\$0.00	0.0%	0.00
● Rebate to Reach MIRR of 14%	\$0.00	0.0%	0.00
● Rebate to Reach MIRR of 15%	\$0.00	0.0%	0.00

System Cost per Watt: \$4.37

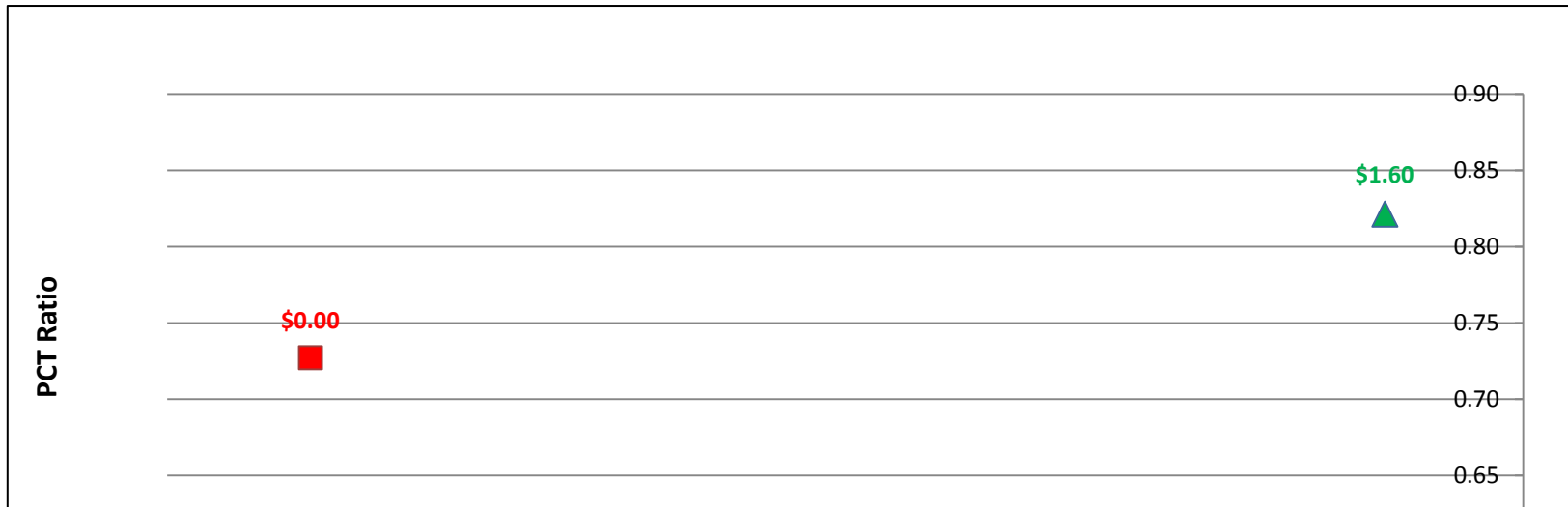


SGIP Cost Effectiveness Report
 Participant Test Results (PCT)
 MIRR Graphs

FC1200kW w/ Natural Gas - Government/Non-Profit - SDG&E

	Rebate (\$/watt)	MIRR	PCT-2014
▲ Actual Rebate - 2014	\$1.60	-4.4%	0.82
■ No Rebate	\$0.00	-15.5%	0.73
● Rebate to Reach MIRR of 5%	\$0.00	0.0%	0.00
● Rebate to Reach MIRR of 6%	\$0.00	0.0%	0.00
● Rebate to Reach MIRR of 7%	\$0.00	0.0%	0.00
● Rebate to Reach MIRR of 8%	\$0.00	0.0%	0.00
● Rebate to Reach MIRR of 9%	\$0.00	0.0%	0.00
● Rebate to Reach MIRR of 10%	\$0.00	0.0%	0.00
● Rebate to Reach MIRR of 11%	\$0.00	0.0%	0.00
● Rebate to Reach MIRR of 12%	\$0.00	0.0%	0.00
● Rebate to Reach MIRR of 13%	\$0.00	0.0%	0.00
● Rebate to Reach MIRR of 14%	\$0.00	0.0%	0.00
● Rebate to Reach MIRR of 15%	\$0.00	0.0%	0.00

System Cost per Watt: \$4.37



SGIP Cost Effectiveness Report
Participant Test Results (PCT)
MIRR Graphs

FC1200kW w/ On-Site BioGas - Government/Non-Profit - PG&E

	Rebate (\$/watt)	MIRR	PCT-2014
▲ Actual Rebate - 2014	\$3.01	12.0%	1.17
■ No Rebate	\$0.00	3.5%	0.98
● Rebate to Reach MIRR of 5%	\$0.00	0.0%	0.00
● Rebate to Reach MIRR of 6%	\$0.00	0.0%	0.00
● Rebate to Reach MIRR of 7%	\$0.00	0.0%	0.00
● Rebate to Reach MIRR of 8%	\$0.00	0.0%	0.00
● Rebate to Reach MIRR of 9%	\$0.00	0.0%	0.00
● Rebate to Reach MIRR of 10%	\$1.84	10.0%	1.10
● Rebate to Reach MIRR of 11%	\$2.36	11.0%	1.13
● Rebate to Reach MIRR of 12%	\$3.00	12.0%	1.17
● Rebate to Reach MIRR of 13%	\$3.67	13.0%	1.21
● Rebate to Reach MIRR of 14%	\$4.51	14.0%	1.25
● Rebate to Reach MIRR of 15%	\$0.00	0.0%	0.00

System Cost per Watt: \$5.18



SGIP Cost Effectiveness Report
Participant Test Results (PCT)
MIRR Graphs

FC1200kW w/ On-Site BioGas - Government/Non-Profit - SCE

	Rebate (\$/watt)	MIRR	PCT-2014
▲ Actual Rebate - 2014	\$3.01	0.2%	0.90
■ No Rebate	\$0.00	-15.1%	0.70
● Rebate to Reach MIRR of 5%	\$5.13	5.0%	1.03
● Rebate to Reach MIRR of 6%	\$0.00	0.0%	0.00
● Rebate to Reach MIRR of 7%	\$0.00	0.0%	0.00
● Rebate to Reach MIRR of 8%	\$0.00	0.0%	0.00
● Rebate to Reach MIRR of 9%	\$0.00	0.0%	0.00
● Rebate to Reach MIRR of 10%	\$0.00	0.0%	0.00
● Rebate to Reach MIRR of 11%	\$0.00	0.0%	0.00
● Rebate to Reach MIRR of 12%	\$0.00	0.0%	0.00
● Rebate to Reach MIRR of 13%	\$0.00	0.0%	0.00
● Rebate to Reach MIRR of 14%	\$0.00	0.0%	0.00
● Rebate to Reach MIRR of 15%	\$0.00	0.0%	0.00

System Cost per Watt: \$5.18

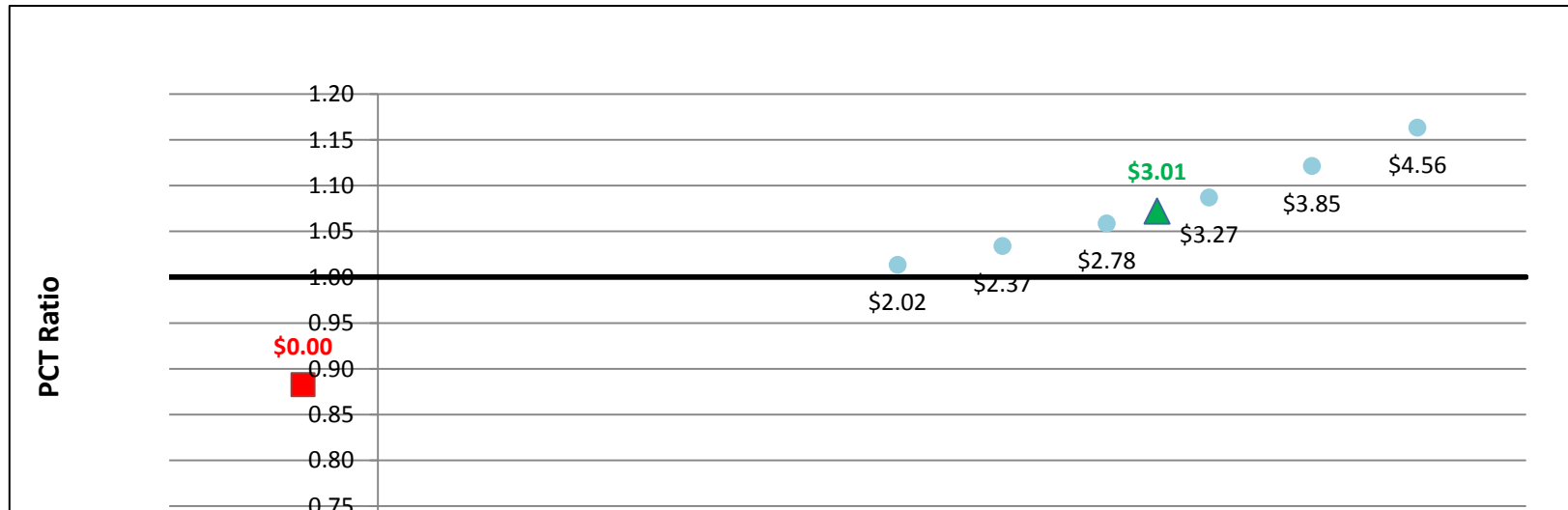


SGIP Cost Effectiveness Report
Participant Test Results (PCT)
MIRR Graphs

FC1200kW w/ On-Site BioGas - Government/Non-Profit - SDG&E

	Rebate (\$/watt)	MIRR	PCT-2014
▲ Actual Rebate - 2014	\$3.01	7.5%	1.07
■ No Rebate	\$0.00	-0.7%	0.88
● Rebate to Reach MIRR of 5%	\$2.02	5.0%	1.01
● Rebate to Reach MIRR of 6%	\$2.37	6.0%	1.03
● Rebate to Reach MIRR of 7%	\$2.78	7.0%	1.06
● Rebate to Reach MIRR of 8%	\$3.27	8.0%	1.09
● Rebate to Reach MIRR of 9%	\$3.85	8.9%	1.12
● Rebate to Reach MIRR of 10%	\$4.56	10.0%	1.16
● Rebate to Reach MIRR of 11%	\$0.00	0.0%	0.00
● Rebate to Reach MIRR of 12%	\$0.00	0.0%	0.00
● Rebate to Reach MIRR of 13%	\$0.00	0.0%	0.00
● Rebate to Reach MIRR of 14%	\$0.00	0.0%	0.00
● Rebate to Reach MIRR of 15%	\$0.00	0.0%	0.00

System Cost per Watt: \$5.18

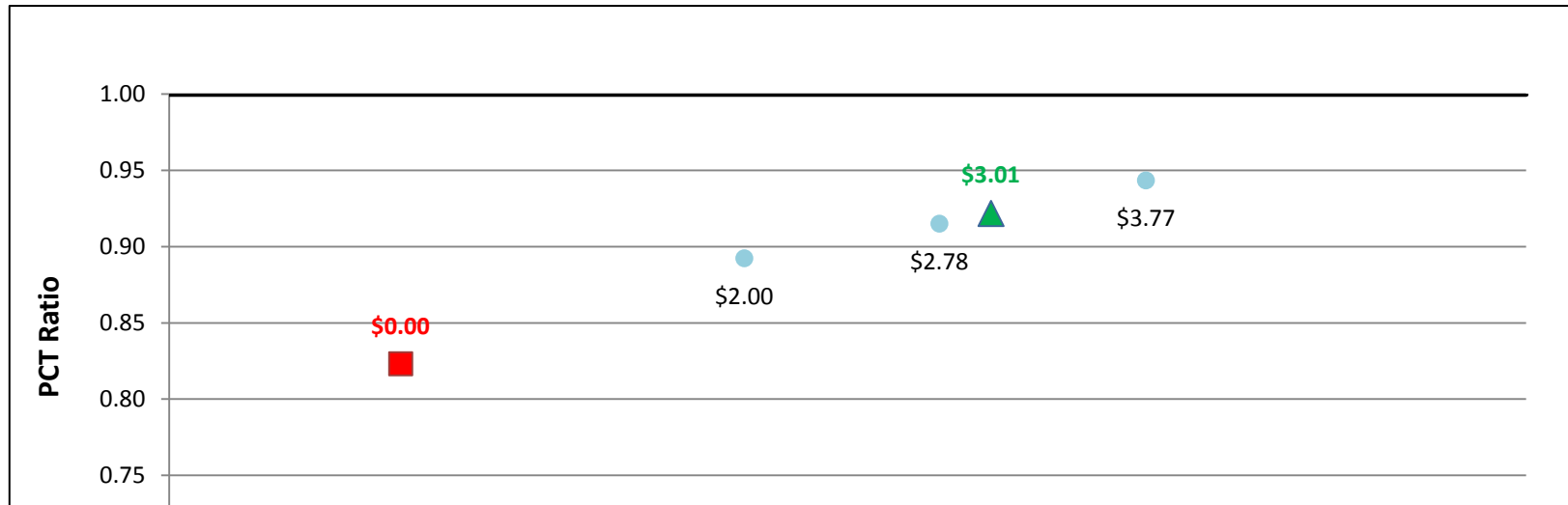


SGIP Cost Effectiveness Report
Participant Test Results (PCT)
MIRR Graphs

FC1200kW w/ Directed BioGas - Commercial - PG&E

	Rebate (\$/watt)	MIRR	PCT-2014
▲ Actual Rebate - 2014	\$3.01	8.2%	0.92
■ No Rebate	\$0.00	5.2%	0.82
● Rebate to Reach MIRR of 5%	\$0.00	0.0%	0.00
● Rebate to Reach MIRR of 6%	\$0.00	0.0%	0.00
● Rebate to Reach MIRR of 7%	\$2.00	7.0%	0.89
● Rebate to Reach MIRR of 8%	\$2.78	8.0%	0.91
● Rebate to Reach MIRR of 9%	\$3.77	9.0%	0.94
● Rebate to Reach MIRR of 10%	\$0.00	0.0%	0.00
● Rebate to Reach MIRR of 11%	\$0.00	0.0%	0.00
● Rebate to Reach MIRR of 12%	\$0.00	0.0%	0.00
● Rebate to Reach MIRR of 13%	\$0.00	0.0%	0.00
● Rebate to Reach MIRR of 14%	\$0.00	0.0%	0.00
● Rebate to Reach MIRR of 15%	\$0.00	0.0%	0.00

System Cost per Watt: \$4.37

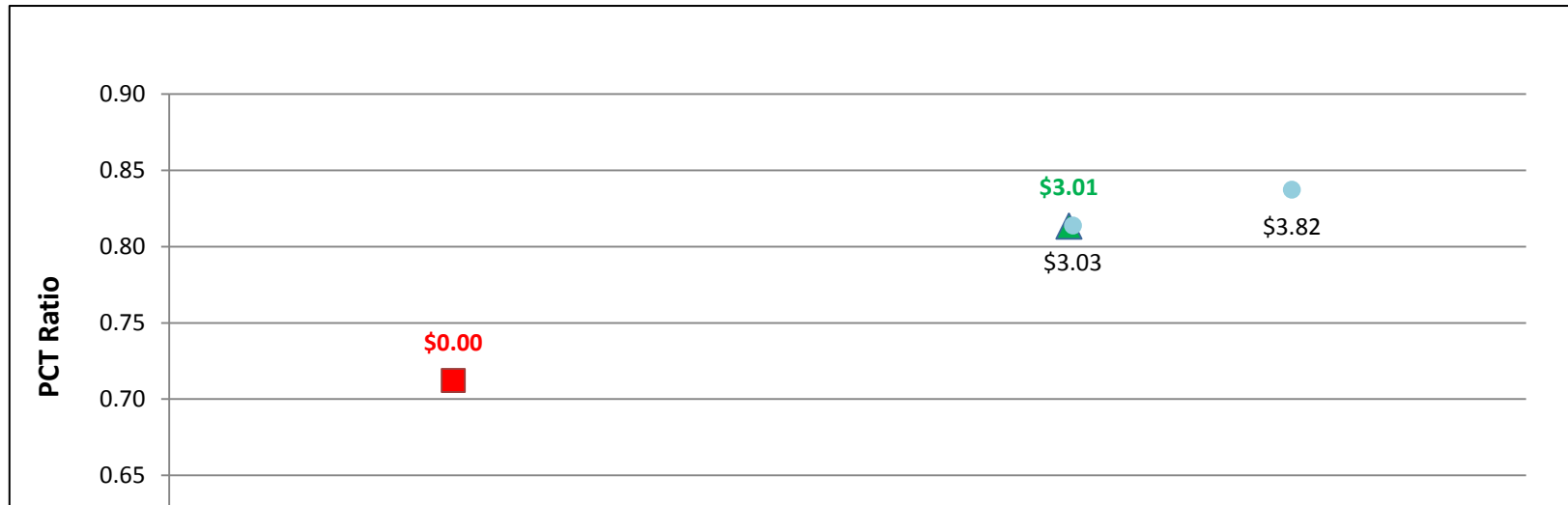


SGIP Cost Effectiveness Report
Participant Test Results (PCT)
MIRR Graphs

FC1200kW w/ Directed BioGas - Commercial - SCE

	Rebate (\$/watt)	MIRR	PCT-2014
▲ Actual Rebate - 2014	\$3.01	5.0%	0.81
■ No Rebate	\$0.00	2.3%	0.71
● Rebate to Reach MIRR of 5%	\$3.03	5.0%	0.81
● Rebate to Reach MIRR of 6%	\$3.82	6.0%	0.84
● Rebate to Reach MIRR of 7%	\$0.00	0.0%	0.00
● Rebate to Reach MIRR of 8%	\$0.00	0.0%	0.00
● Rebate to Reach MIRR of 9%	\$0.00	0.0%	0.00
● Rebate to Reach MIRR of 10%	\$0.00	0.0%	0.00
● Rebate to Reach MIRR of 11%	\$0.00	0.0%	0.00
● Rebate to Reach MIRR of 12%	\$0.00	0.0%	0.00
● Rebate to Reach MIRR of 13%	\$0.00	0.0%	0.00
● Rebate to Reach MIRR of 14%	\$0.00	0.0%	0.00
● Rebate to Reach MIRR of 15%	\$0.00	0.0%	0.00

System Cost per Watt: \$4.37

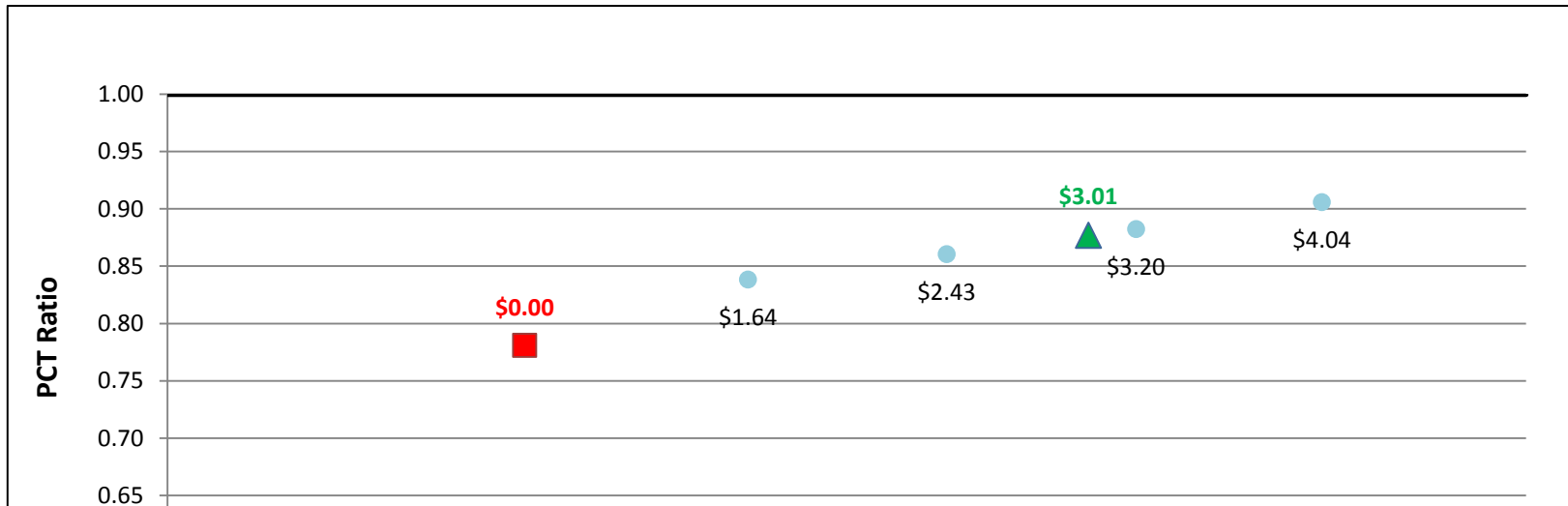


SGIP Cost Effectiveness Report
Participant Test Results (PCT)
MIRR Graphs

FC1200kW w/ Directed BioGas - Commercial - SDG&E

	Rebate (\$/watt)	MIRR	PCT-2014
▲ Actual Rebate - 2014	\$3.01	6.7%	0.88
■ No Rebate	\$0.00	3.8%	0.78
● Rebate to Reach MIRR of 5%	\$1.64	5.0%	0.84
● Rebate to Reach MIRR of 6%	\$2.43	6.0%	0.86
● Rebate to Reach MIRR of 7%	\$3.20	7.0%	0.88
● Rebate to Reach MIRR of 8%	\$4.04	7.9%	0.91
● Rebate to Reach MIRR of 9%	\$0.00	0.0%	0.00
● Rebate to Reach MIRR of 10%	\$0.00	0.0%	0.00
● Rebate to Reach MIRR of 11%	\$0.00	0.0%	0.00
● Rebate to Reach MIRR of 12%	\$0.00	0.0%	0.00
● Rebate to Reach MIRR of 13%	\$0.00	0.0%	0.00
● Rebate to Reach MIRR of 14%	\$0.00	0.0%	0.00
● Rebate to Reach MIRR of 15%	\$0.00	0.0%	0.00

System Cost per Watt: \$4.37

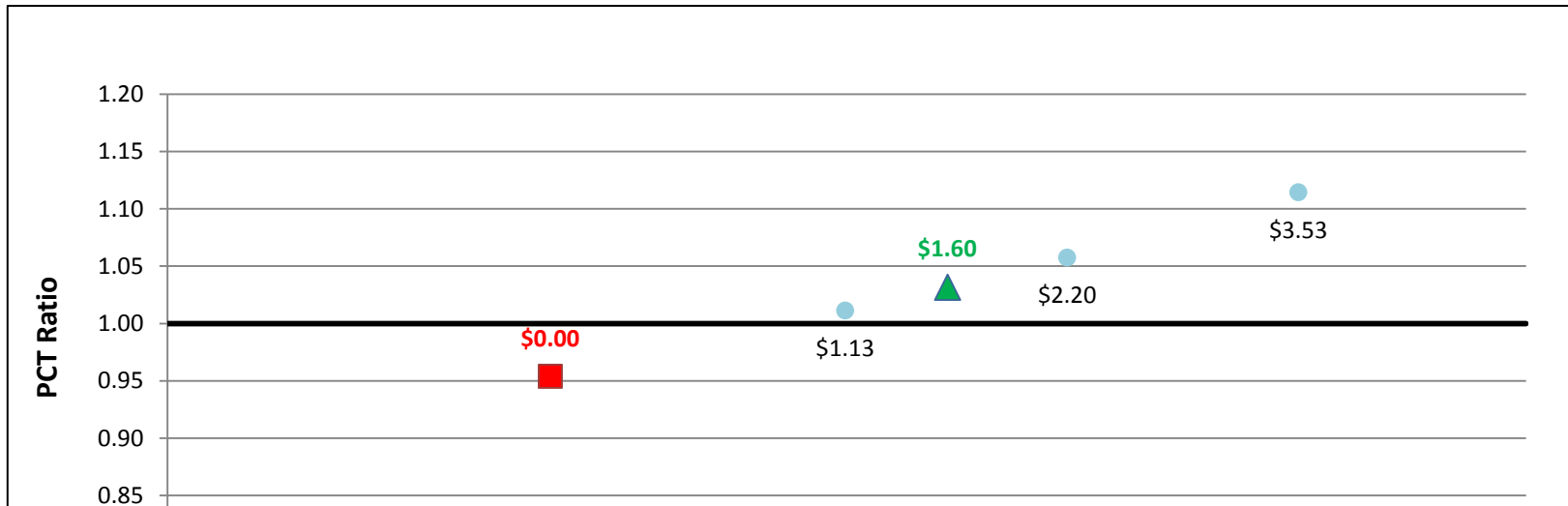


SGIP Cost Effectiveness Report
Participant Test Results (PCT)
MIRR Graphs

FC1200kW w/ Natural Gas - Commercial - PG&E

	Rebate (\$/watt)	MIRR	PCT-2014
▲ Actual Rebate - 2014	\$1.60	11.4%	1.03
■ No Rebate	\$0.00	9.7%	0.95
● Rebate to Reach MIRR of 5%	\$0.00	0.0%	0.00
● Rebate to Reach MIRR of 6%	\$0.00	0.0%	0.00
● Rebate to Reach MIRR of 7%	\$0.00	0.0%	0.00
● Rebate to Reach MIRR of 8%	\$0.00	0.0%	0.00
● Rebate to Reach MIRR of 9%	\$0.00	0.0%	0.00
● Rebate to Reach MIRR of 10%	\$0.00	0.0%	0.00
● Rebate to Reach MIRR of 11%	\$1.13	11.0%	1.01
● Rebate to Reach MIRR of 12%	\$2.20	12.0%	1.06
● Rebate to Reach MIRR of 13%	\$3.53	13.0%	1.11
● Rebate to Reach MIRR of 14%	\$0.00	0.0%	0.00
● Rebate to Reach MIRR of 15%	\$0.00	0.0%	0.00

System Cost per Watt: \$4.37

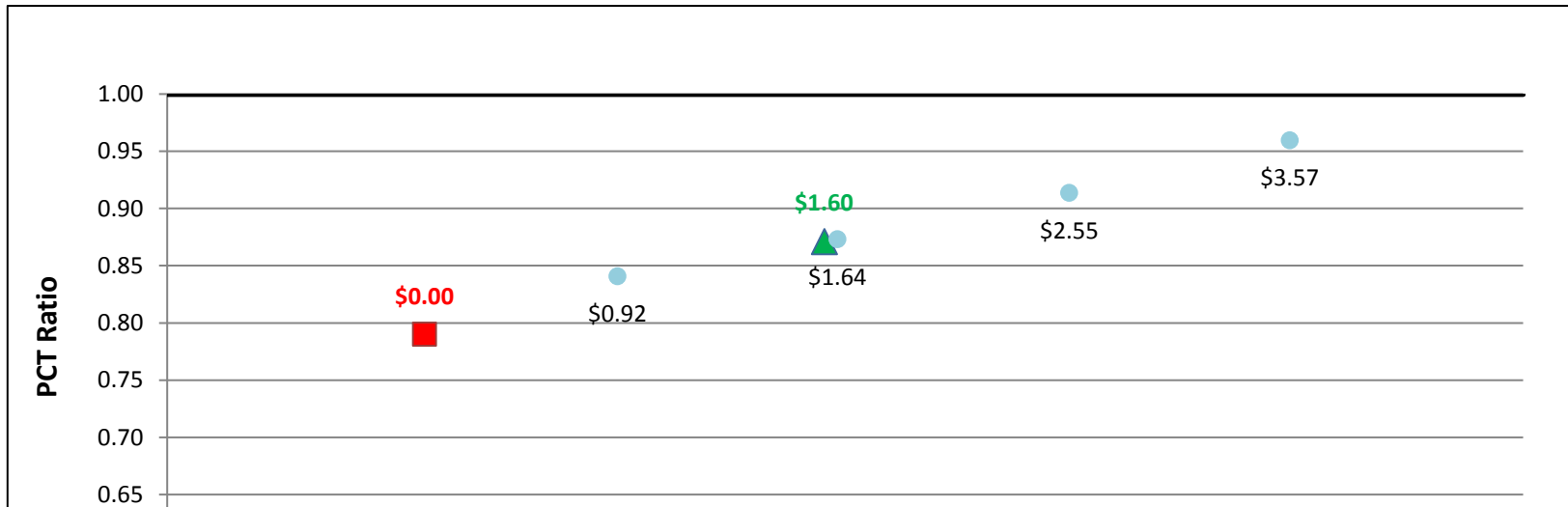


SGIP Cost Effectiveness Report
Participant Test Results (PCT)
MIRR Graphs

FC1200kW w/ Natural Gas - Commercial - SCE

	Rebate (\$/watt)	MIRR	PCT-2014
▲ Actual Rebate - 2014	\$1.60	7.9%	0.87
■ No Rebate	\$0.00	6.1%	0.79
● Rebate to Reach MIRR of 5%	\$0.00	0.0%	0.00
● Rebate to Reach MIRR of 6%	\$0.00	0.0%	0.00
● Rebate to Reach MIRR of 7%	\$0.92	7.0%	0.84
● Rebate to Reach MIRR of 8%	\$1.64	8.0%	0.87
● Rebate to Reach MIRR of 9%	\$2.55	9.0%	0.91
● Rebate to Reach MIRR of 10%	\$3.57	10.0%	0.96
● Rebate to Reach MIRR of 11%	\$0.00	0.0%	0.00
● Rebate to Reach MIRR of 12%	\$0.00	0.0%	0.00
● Rebate to Reach MIRR of 13%	\$0.00	0.0%	0.00
● Rebate to Reach MIRR of 14%	\$0.00	0.0%	0.00
● Rebate to Reach MIRR of 15%	\$0.00	0.0%	0.00

System Cost per Watt: \$4.37

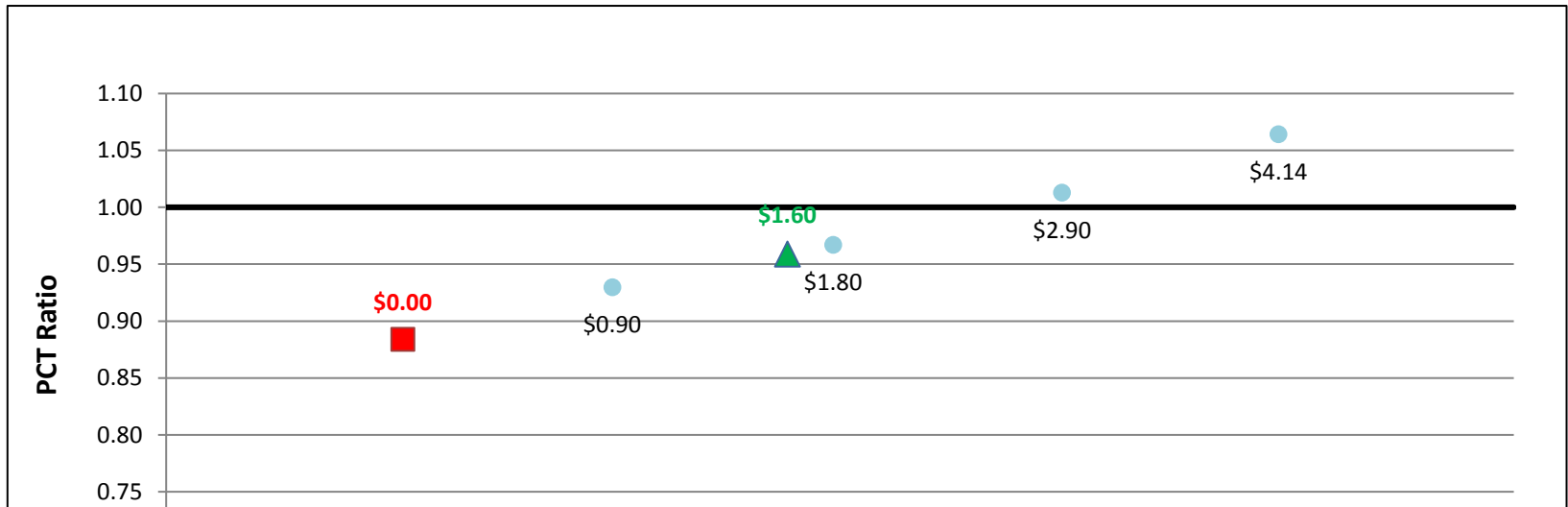


SGIP Cost Effectiveness Report
 Participant Test Results (PCT)
 MIRR Graphs

FC1200kW w/ Natural Gas - Commercial - SDG&E

	Rebate (\$/watt)	MIRR	PCT-2014
▲ Actual Rebate - 2014	\$1.60	9.8%	0.96
■ No Rebate	\$0.00	8.1%	0.88
● Rebate to Reach MIRR of 5%	\$0.00	0.0%	0.00
● Rebate to Reach MIRR of 6%	\$0.00	0.0%	0.00
● Rebate to Reach MIRR of 7%	\$0.00	0.0%	0.00
● Rebate to Reach MIRR of 8%	\$0.00	0.0%	0.00
● Rebate to Reach MIRR of 9%	\$0.90	9.0%	0.93
● Rebate to Reach MIRR of 10%	\$1.80	10.0%	0.97
● Rebate to Reach MIRR of 11%	\$2.90	11.0%	1.01
● Rebate to Reach MIRR of 12%	\$4.14	12.0%	1.06
● Rebate to Reach MIRR of 13%	\$0.00	0.0%	0.00
● Rebate to Reach MIRR of 14%	\$0.00	0.0%	0.00
● Rebate to Reach MIRR of 15%	\$0.00	0.0%	0.00

System Cost per Watt: \$4.37



SGIP Cost Effectiveness Report
Participant Test Results (PCT)
MIRR Graphs

FC1200kW w/ On-Site BioGas - Commercial - PG&E

	Rebate (\$/watt)	MIRR	PCT-2014
▲ Actual Rebate - 2014	\$3.01	14.7%	1.20
■ No Rebate	\$0.00	11.6%	1.05
● Rebate to Reach MIRR of 5%	\$0.00	0.0%	0.00
● Rebate to Reach MIRR of 6%	\$0.00	0.0%	0.00
● Rebate to Reach MIRR of 7%	\$0.00	0.0%	0.00
● Rebate to Reach MIRR of 8%	\$0.00	0.0%	0.00
● Rebate to Reach MIRR of 9%	\$0.00	0.0%	0.00
● Rebate to Reach MIRR of 10%	\$0.00	0.0%	0.00
● Rebate to Reach MIRR of 11%	\$0.00	0.0%	0.00
● Rebate to Reach MIRR of 12%	\$0.00	0.0%	0.00
● Rebate to Reach MIRR of 13%	\$0.00	0.0%	0.00
● Rebate to Reach MIRR of 14%	\$1.92	14.0%	1.15
● Rebate to Reach MIRR of 15%	\$3.55	15.1%	1.22

System Cost per Watt: \$5.18

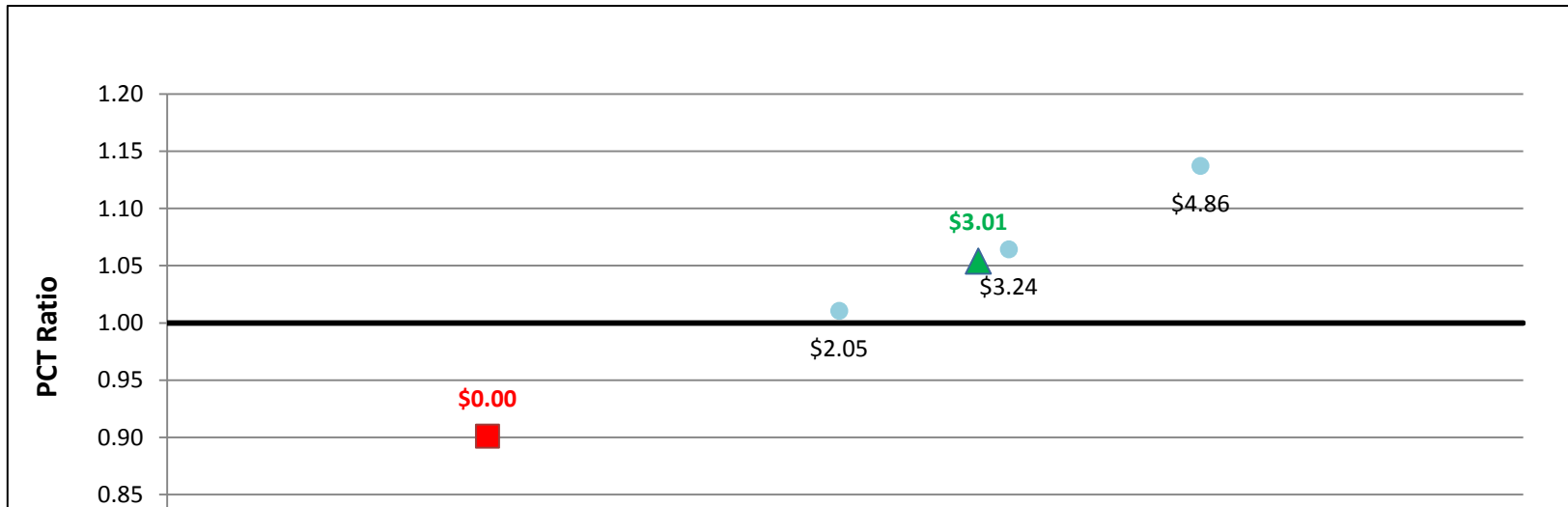


SGIP Cost Effectiveness Report
Participant Test Results (PCT)
MIRR Graphs

FC1200kW w/ On-Site BioGas - Commercial - SCE

	Rebate (\$/watt)	MIRR	PCT-2014
▲ Actual Rebate - 2014	\$3.01	11.8%	1.05
■ No Rebate	\$0.00	8.9%	0.90
● Rebate to Reach MIRR of 5%	\$0.00	0.0%	0.00
● Rebate to Reach MIRR of 6%	\$0.00	0.0%	0.00
● Rebate to Reach MIRR of 7%	\$0.00	0.0%	0.00
● Rebate to Reach MIRR of 8%	\$0.00	0.0%	0.00
● Rebate to Reach MIRR of 9%	\$0.00	0.0%	0.00
● Rebate to Reach MIRR of 10%	\$0.00	0.0%	0.00
● Rebate to Reach MIRR of 11%	\$2.05	11.0%	1.01
● Rebate to Reach MIRR of 12%	\$3.24	12.0%	1.06
● Rebate to Reach MIRR of 13%	\$4.86	13.1%	1.14
● Rebate to Reach MIRR of 14%	\$0.00	0.0%	0.00
● Rebate to Reach MIRR of 15%	\$0.00	0.0%	0.00

System Cost per Watt: \$5.18

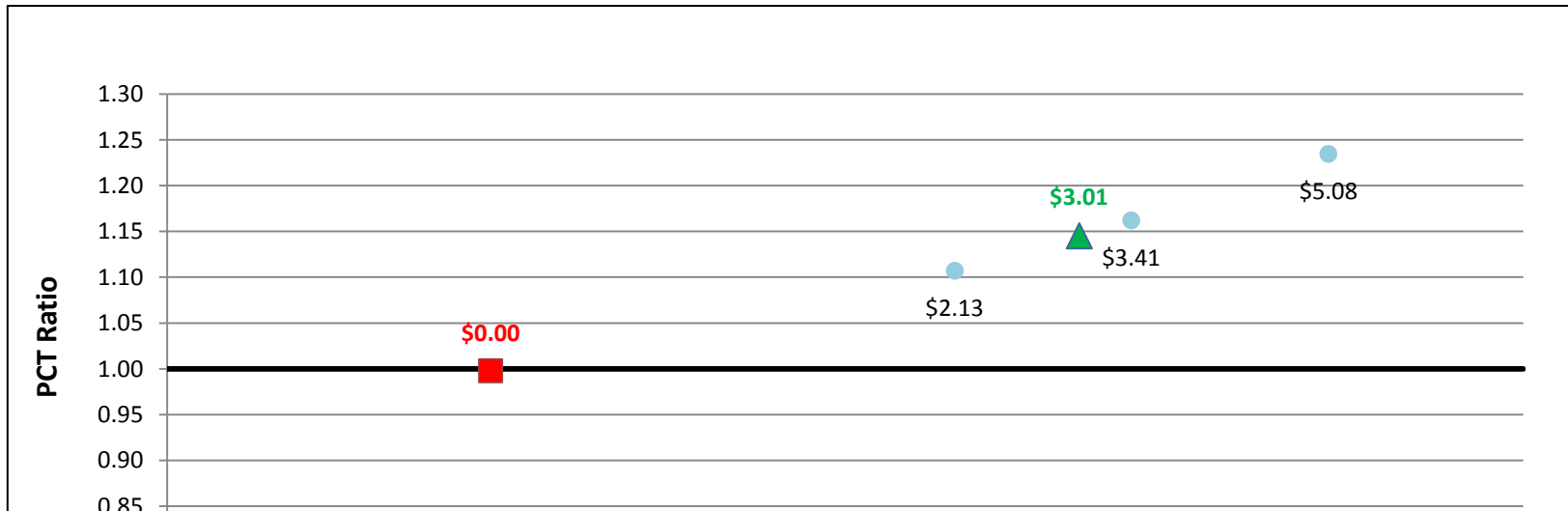


SGIP Cost Effectiveness Report
Participant Test Results (PCT)
MIRR Graphs

FC1200kW w/ On-Site BioGas - Commercial - SDG&E

	Rebate (\$/watt)	MIRR	PCT-2014
▲ Actual Rebate - 2014	\$3.01	13.7%	1.14
■ No Rebate	\$0.00	10.7%	1.00
● Rebate to Reach MIRR of 5%	\$0.00	0.0%	0.00
● Rebate to Reach MIRR of 6%	\$0.00	0.0%	0.00
● Rebate to Reach MIRR of 7%	\$0.00	0.0%	0.00
● Rebate to Reach MIRR of 8%	\$0.00	0.0%	0.00
● Rebate to Reach MIRR of 9%	\$0.00	0.0%	0.00
● Rebate to Reach MIRR of 10%	\$0.00	0.0%	0.00
● Rebate to Reach MIRR of 11%	\$0.00	0.0%	0.00
● Rebate to Reach MIRR of 12%	\$0.00	0.0%	0.00
● Rebate to Reach MIRR of 13%	\$2.13	13.1%	1.11
● Rebate to Reach MIRR of 14%	\$3.41	14.0%	1.16
● Rebate to Reach MIRR of 15%	\$5.08	15.0%	1.23

System Cost per Watt: \$5.18



SGIP Cost Effectiveness Report
Participant Test Results (PCT)
MIRR Graphs

FC500kW w/ Directed BioGas - Government/Non-Profit - PG&E

	Rebate (\$/watt)	MIRR	PCT-2014
▲ Actual Rebate - 2014	\$3.29	-19.9%	0.69
■ No Rebate	\$0.00	-100.0%	0.57
● Rebate to Reach MIRR of 5%	\$0.00	0.0%	0.00
● Rebate to Reach MIRR of 6%	\$0.00	0.0%	0.00
● Rebate to Reach MIRR of 7%	\$0.00	0.0%	0.00
● Rebate to Reach MIRR of 8%	\$0.00	0.0%	0.00
● Rebate to Reach MIRR of 9%	\$0.00	0.0%	0.00
● Rebate to Reach MIRR of 10%	\$0.00	0.0%	0.00
● Rebate to Reach MIRR of 11%	\$0.00	0.0%	0.00
● Rebate to Reach MIRR of 12%	\$0.00	0.0%	0.00
● Rebate to Reach MIRR of 13%	\$0.00	0.0%	0.00
● Rebate to Reach MIRR of 14%	\$0.00	0.0%	0.00
● Rebate to Reach MIRR of 15%	\$0.00	0.0%	0.00

System Cost per Watt: \$7.28



SGIP Cost Effectiveness Report
Participant Test Results (PCT)
MIRR Graphs

FC500kW w/ Directed BioGas - Government/Non-Profit - SCE

	Rebate (\$/watt)	MIRR	PCT-2014
▲ Actual Rebate - 2014	\$3.29	-100.0%	0.51
■ No Rebate	\$0.00	-100.0%	0.39
● Rebate to Reach MIRR of 5%	\$0.00	0.0%	0.00
● Rebate to Reach MIRR of 6%	\$0.00	0.0%	0.00
● Rebate to Reach MIRR of 7%	\$0.00	0.0%	0.00
● Rebate to Reach MIRR of 8%	\$0.00	0.0%	0.00
● Rebate to Reach MIRR of 9%	\$0.00	0.0%	0.00
● Rebate to Reach MIRR of 10%	\$0.00	0.0%	0.00
● Rebate to Reach MIRR of 11%	\$0.00	0.0%	0.00
● Rebate to Reach MIRR of 12%	\$0.00	0.0%	0.00
● Rebate to Reach MIRR of 13%	\$0.00	0.0%	0.00
● Rebate to Reach MIRR of 14%	\$0.00	0.0%	0.00
● Rebate to Reach MIRR of 15%	\$0.00	0.0%	0.00

System Cost per Watt: \$7.28



SGIP Cost Effectiveness Report
Participant Test Results (PCT)
MIRR Graphs

FC500kW w/ Directed BioGas - Government/Non-Profit - SDG&E

	Rebate (\$/watt)	MIRR	PCT-2014
▲ Actual Rebate - 2014	\$3.29	-100.0%	0.61
■ No Rebate	\$0.00	-100.0%	0.49
● Rebate to Reach MIRR of 5%	\$0.00	0.0%	0.00
● Rebate to Reach MIRR of 6%	\$0.00	0.0%	0.00
● Rebate to Reach MIRR of 7%	\$0.00	0.0%	0.00
● Rebate to Reach MIRR of 8%	\$0.00	0.0%	0.00
● Rebate to Reach MIRR of 9%	\$0.00	0.0%	0.00
● Rebate to Reach MIRR of 10%	\$0.00	0.0%	0.00
● Rebate to Reach MIRR of 11%	\$0.00	0.0%	0.00
● Rebate to Reach MIRR of 12%	\$0.00	0.0%	0.00
● Rebate to Reach MIRR of 13%	\$0.00	0.0%	0.00
● Rebate to Reach MIRR of 14%	\$0.00	0.0%	0.00
● Rebate to Reach MIRR of 15%	\$0.00	0.0%	0.00

System Cost per Watt: \$7.28

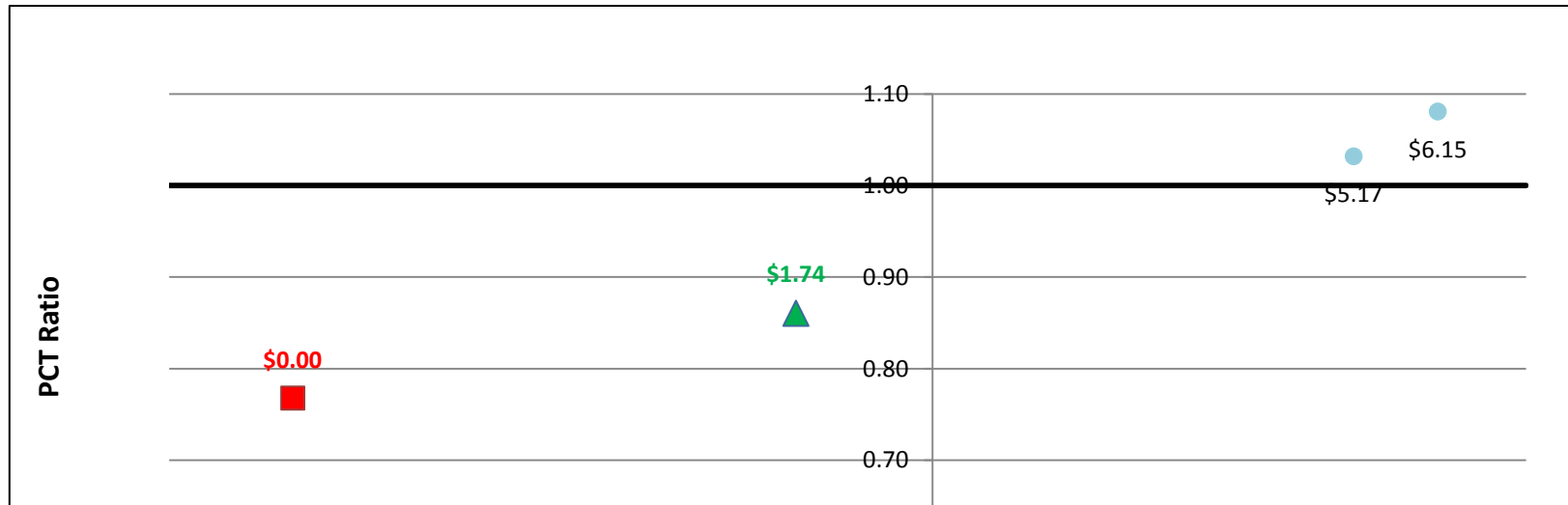


SGIP Cost Effectiveness Report
 Participant Test Results (PCT)
 MIRR Graphs

FC500kW w/ Natural Gas - Government/Non-Profit - PG&E

	Rebate (\$/watt)	MIRR	PCT-2014
▲ Actual Rebate - 2014	\$1.74	-1.6%	0.86
■ No Rebate	\$0.00	-7.5%	0.77
● Rebate to Reach MIRR of 5%	\$5.17	5.0%	1.03
● Rebate to Reach MIRR of 6%	\$6.15	6.0%	1.08
● Rebate to Reach MIRR of 7%	\$0.00	0.0%	0.00
● Rebate to Reach MIRR of 8%	\$0.00	0.0%	0.00
● Rebate to Reach MIRR of 9%	\$0.00	0.0%	0.00
● Rebate to Reach MIRR of 10%	\$0.00	0.0%	0.00
● Rebate to Reach MIRR of 11%	\$0.00	0.0%	0.00
● Rebate to Reach MIRR of 12%	\$0.00	0.0%	0.00
● Rebate to Reach MIRR of 13%	\$0.00	0.0%	0.00
● Rebate to Reach MIRR of 14%	\$0.00	0.0%	0.00
● Rebate to Reach MIRR of 15%	\$0.00	0.0%	0.00

System Cost per Watt: \$7.28



SGIP Cost Effectiveness Report
Participant Test Results (PCT)
MIRR Graphs

FC500kW w/ Natural Gas - Government/Non-Profit - SCE

	Rebate (\$/watt)	MIRR	PCT-2014
▲ Actual Rebate - 2014	\$1.74	-100.0%	0.59
■ No Rebate	\$0.00	-100.0%	0.49
● Rebate to Reach MIRR of 5%	\$0.00	0.0%	0.00
● Rebate to Reach MIRR of 6%	\$0.00	0.0%	0.00
● Rebate to Reach MIRR of 7%	\$0.00	0.0%	0.00
● Rebate to Reach MIRR of 8%	\$0.00	0.0%	0.00
● Rebate to Reach MIRR of 9%	\$0.00	0.0%	0.00
● Rebate to Reach MIRR of 10%	\$0.00	0.0%	0.00
● Rebate to Reach MIRR of 11%	\$0.00	0.0%	0.00
● Rebate to Reach MIRR of 12%	\$0.00	0.0%	0.00
● Rebate to Reach MIRR of 13%	\$0.00	0.0%	0.00
● Rebate to Reach MIRR of 14%	\$0.00	0.0%	0.00
● Rebate to Reach MIRR of 15%	\$0.00	0.0%	0.00

System Cost per Watt: \$7.28



SGIP Cost Effectiveness Report
Participant Test Results (PCT)
MIRR Graphs

FC500kW w/ Natural Gas - Government/Non-Profit - SDG&E

	Rebate (\$/watt)	MIRR	PCT-2014
▲ Actual Rebate - 2014	\$1.74	-12.0%	0.71
■ No Rebate	\$0.00	-100.0%	0.63
● Rebate to Reach MIRR of 5%	\$0.00	0.0%	0.00
● Rebate to Reach MIRR of 6%	\$0.00	0.0%	0.00
● Rebate to Reach MIRR of 7%	\$0.00	0.0%	0.00
● Rebate to Reach MIRR of 8%	\$0.00	0.0%	0.00
● Rebate to Reach MIRR of 9%	\$0.00	0.0%	0.00
● Rebate to Reach MIRR of 10%	\$0.00	0.0%	0.00
● Rebate to Reach MIRR of 11%	\$0.00	0.0%	0.00
● Rebate to Reach MIRR of 12%	\$0.00	0.0%	0.00
● Rebate to Reach MIRR of 13%	\$0.00	0.0%	0.00
● Rebate to Reach MIRR of 14%	\$0.00	0.0%	0.00
● Rebate to Reach MIRR of 15%	\$0.00	0.0%	0.00

System Cost per Watt: \$7.28



SGIP Cost Effectiveness Report
Participant Test Results (PCT)
MIRR Graphs

FC500kW w/ On-Site BioGas - Government/Non-Profit - PG&E

	Rebate (\$/watt)	MIRR	PCT-2014
▲ Actual Rebate - 2014	\$3.29	-17.4%	0.67
■ No Rebate	\$0.00	-100.0%	0.55
● Rebate to Reach MIRR of 5%	\$0.00	0.0%	0.00
● Rebate to Reach MIRR of 6%	\$0.00	0.0%	0.00
● Rebate to Reach MIRR of 7%	\$0.00	0.0%	0.00
● Rebate to Reach MIRR of 8%	\$0.00	0.0%	0.00
● Rebate to Reach MIRR of 9%	\$0.00	0.0%	0.00
● Rebate to Reach MIRR of 10%	\$0.00	0.0%	0.00
● Rebate to Reach MIRR of 11%	\$0.00	0.0%	0.00
● Rebate to Reach MIRR of 12%	\$0.00	0.0%	0.00
● Rebate to Reach MIRR of 13%	\$0.00	0.0%	0.00
● Rebate to Reach MIRR of 14%	\$0.00	0.0%	0.00
● Rebate to Reach MIRR of 15%	\$0.00	0.0%	0.00

System Cost per Watt: \$8.34



SGIP Cost Effectiveness Report
Participant Test Results (PCT)
MIRR Graphs

FC500kW w/ On-Site BioGas - Government/Non-Profit - SCE

	Rebate (\$/watt)	MIRR	PCT-2014
▲ Actual Rebate - 2014	\$3.29	-100.0%	0.50
■ No Rebate	\$0.00	-100.0%	0.38
● Rebate to Reach MIRR of 5%	\$0.00	0.0%	0.00
● Rebate to Reach MIRR of 6%	\$0.00	0.0%	0.00
● Rebate to Reach MIRR of 7%	\$0.00	0.0%	0.00
● Rebate to Reach MIRR of 8%	\$0.00	0.0%	0.00
● Rebate to Reach MIRR of 9%	\$0.00	0.0%	0.00
● Rebate to Reach MIRR of 10%	\$0.00	0.0%	0.00
● Rebate to Reach MIRR of 11%	\$0.00	0.0%	0.00
● Rebate to Reach MIRR of 12%	\$0.00	0.0%	0.00
● Rebate to Reach MIRR of 13%	\$0.00	0.0%	0.00
● Rebate to Reach MIRR of 14%	\$0.00	0.0%	0.00
● Rebate to Reach MIRR of 15%	\$0.00	0.0%	0.00

System Cost per Watt: \$8.34



SGIP Cost Effectiveness Report
Participant Test Results (PCT)
MIRR Graphs

FC500kW w/ On-Site BioGas - Government/Non-Profit - SDG&E

	Rebate (\$/watt)	MIRR	PCT-2014
▲ Actual Rebate - 2014	\$3.29	-100.0%	0.61
■ No Rebate	\$0.00	-100.0%	0.49
● Rebate to Reach MIRR of 5%	\$0.00	0.0%	0.00
● Rebate to Reach MIRR of 6%	\$0.00	0.0%	0.00
● Rebate to Reach MIRR of 7%	\$0.00	0.0%	0.00
● Rebate to Reach MIRR of 8%	\$0.00	0.0%	0.00
● Rebate to Reach MIRR of 9%	\$0.00	0.0%	0.00
● Rebate to Reach MIRR of 10%	\$0.00	0.0%	0.00
● Rebate to Reach MIRR of 11%	\$0.00	0.0%	0.00
● Rebate to Reach MIRR of 12%	\$0.00	0.0%	0.00
● Rebate to Reach MIRR of 13%	\$0.00	0.0%	0.00
● Rebate to Reach MIRR of 14%	\$0.00	0.0%	0.00
● Rebate to Reach MIRR of 15%	\$0.00	0.0%	0.00

System Cost per Watt: \$8.34

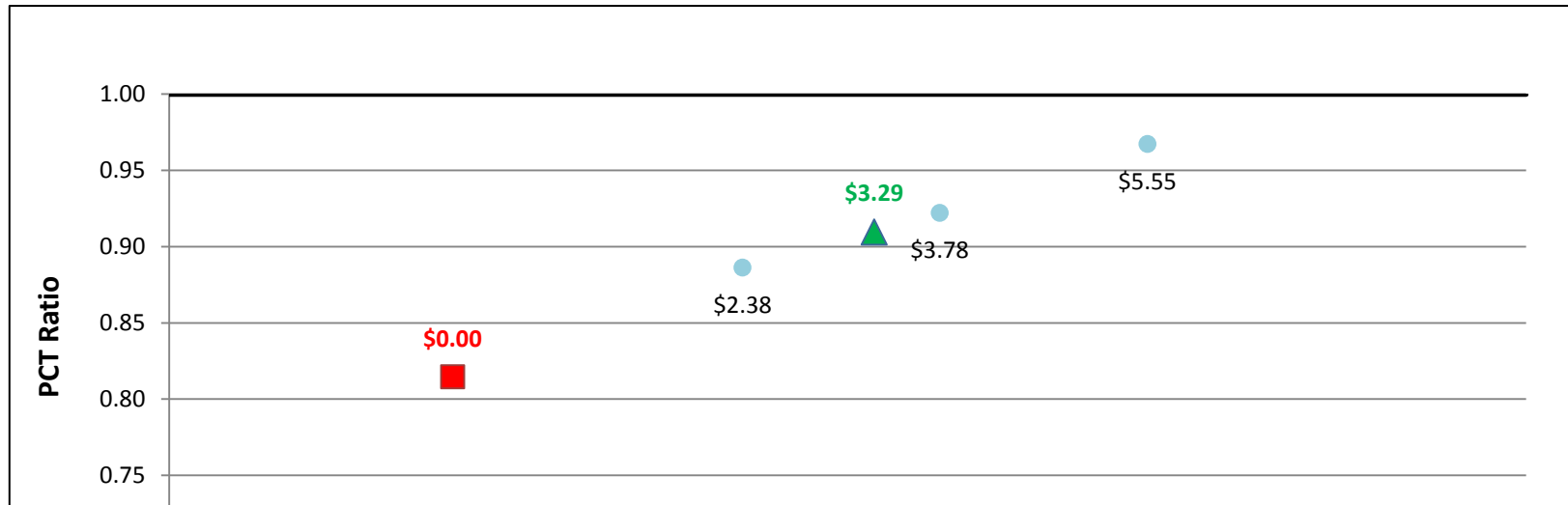


SGIP Cost Effectiveness Report
Participant Test Results (PCT)
MIRR Graphs

FC500kW w/ Directed BioGas - Commercial - PG&E

	Rebate (\$/watt)	MIRR	PCT-2014
▲ Actual Rebate - 2014	\$3.29	8.6%	0.91
■ No Rebate	\$0.00	6.5%	0.81
● Rebate to Reach MIRR of 5%	\$0.00	0.0%	0.00
● Rebate to Reach MIRR of 6%	\$0.00	0.0%	0.00
● Rebate to Reach MIRR of 7%	\$0.00	0.0%	0.00
● Rebate to Reach MIRR of 8%	\$2.38	8.0%	0.89
● Rebate to Reach MIRR of 9%	\$3.78	9.0%	0.92
● Rebate to Reach MIRR of 10%	\$5.55	10.0%	0.97
● Rebate to Reach MIRR of 11%	\$0.00	0.0%	0.00
● Rebate to Reach MIRR of 12%	\$0.00	0.0%	0.00
● Rebate to Reach MIRR of 13%	\$0.00	0.0%	0.00
● Rebate to Reach MIRR of 14%	\$0.00	0.0%	0.00
● Rebate to Reach MIRR of 15%	\$0.00	0.0%	0.00

System Cost per Watt: \$7.28

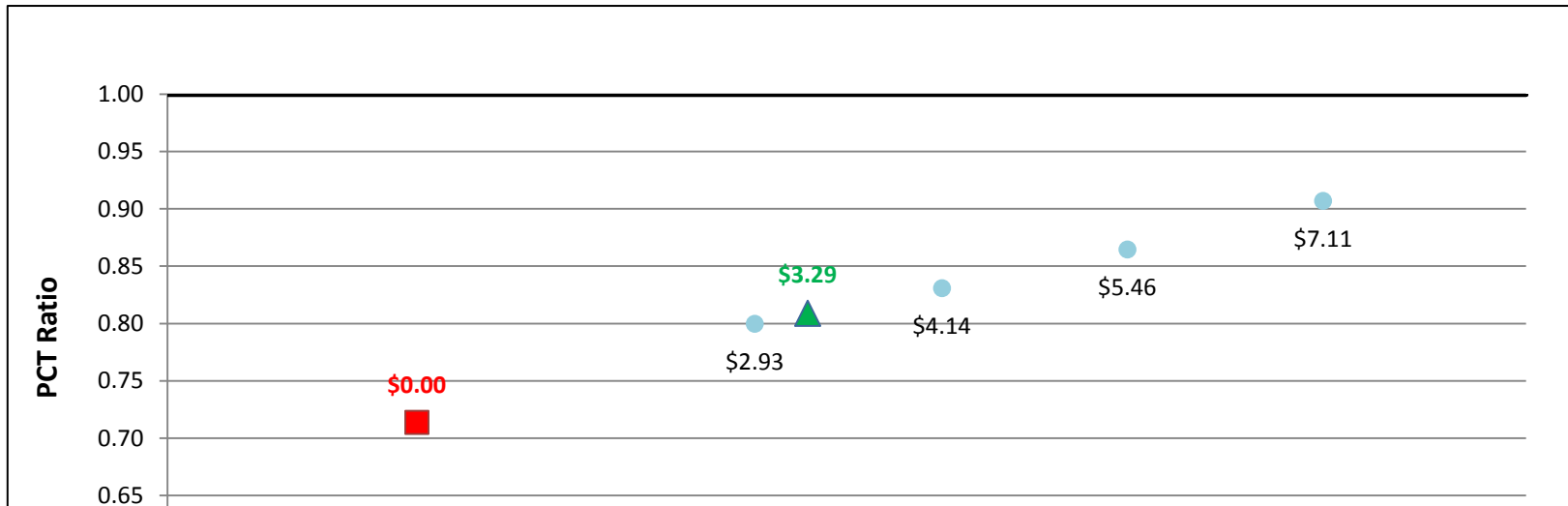


SGIP Cost Effectiveness Report
Participant Test Results (PCT)
MIRR Graphs

FC500kW w/ Directed BioGas - Commercial - SCE

	Rebate (\$/watt)	MIRR	PCT-2014
▲ Actual Rebate - 2014	\$3.29	6.3%	0.81
■ No Rebate	\$0.00	4.3%	0.71
● Rebate to Reach MIRR of 5%	\$0.00	0.0%	0.00
● Rebate to Reach MIRR of 6%	\$2.93	6.0%	0.80
● Rebate to Reach MIRR of 7%	\$4.14	7.0%	0.83
● Rebate to Reach MIRR of 8%	\$5.46	7.9%	0.86
● Rebate to Reach MIRR of 9%	\$7.11	9.0%	0.91
● Rebate to Reach MIRR of 10%	\$0.00	0.0%	0.00
● Rebate to Reach MIRR of 11%	\$0.00	0.0%	0.00
● Rebate to Reach MIRR of 12%	\$0.00	0.0%	0.00
● Rebate to Reach MIRR of 13%	\$0.00	0.0%	0.00
● Rebate to Reach MIRR of 14%	\$0.00	0.0%	0.00
● Rebate to Reach MIRR of 15%	\$0.00	0.0%	0.00

System Cost per Watt: \$7.28

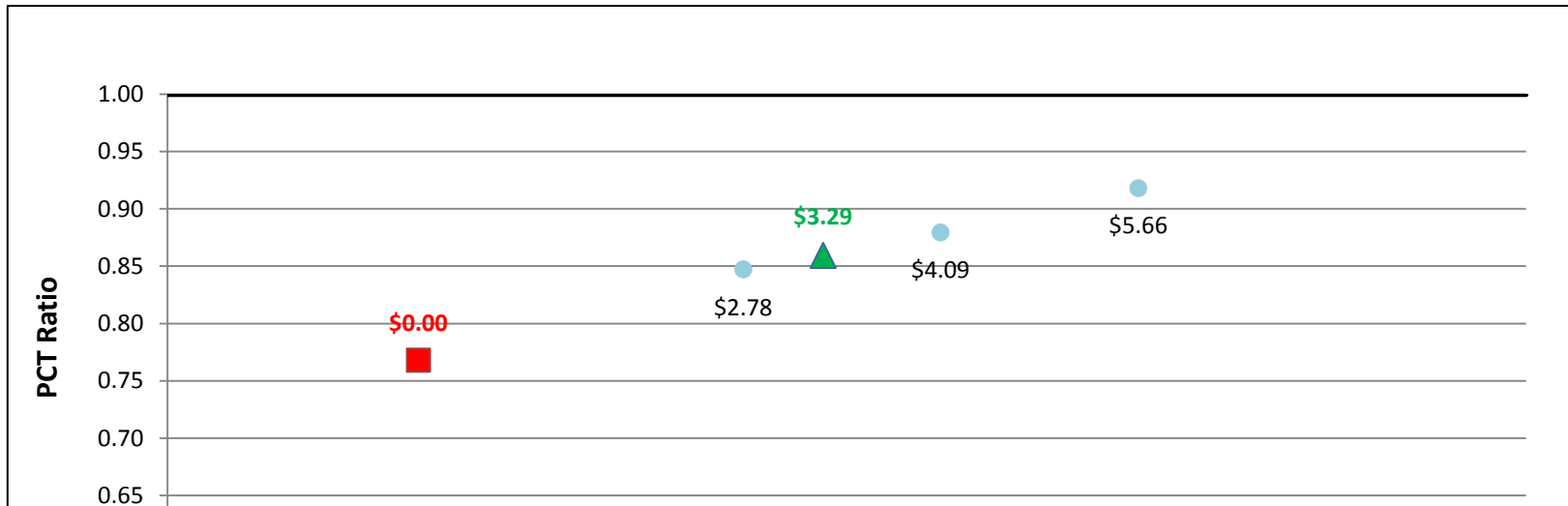


SGIP Cost Effectiveness Report
Participant Test Results (PCT)
MIRR Graphs

FC500kW w/ Directed BioGas - Commercial - SDG&E

	Rebate (\$/watt)	MIRR	PCT-2014
▲ Actual Rebate - 2014	\$3.29	7.4%	0.86
■ No Rebate	\$0.00	5.3%	0.77
● Rebate to Reach MIRR of 5%	\$0.00	0.0%	0.00
● Rebate to Reach MIRR of 6%	\$0.00	0.0%	0.00
● Rebate to Reach MIRR of 7%	\$2.78	7.0%	0.85
● Rebate to Reach MIRR of 8%	\$4.09	8.0%	0.88
● Rebate to Reach MIRR of 9%	\$5.66	9.0%	0.92
● Rebate to Reach MIRR of 10%	\$0.00	0.0%	0.00
● Rebate to Reach MIRR of 11%	\$0.00	0.0%	0.00
● Rebate to Reach MIRR of 12%	\$0.00	0.0%	0.00
● Rebate to Reach MIRR of 13%	\$0.00	0.0%	0.00
● Rebate to Reach MIRR of 14%	\$0.00	0.0%	0.00
● Rebate to Reach MIRR of 15%	\$0.00	0.0%	0.00

System Cost per Watt: \$7.28

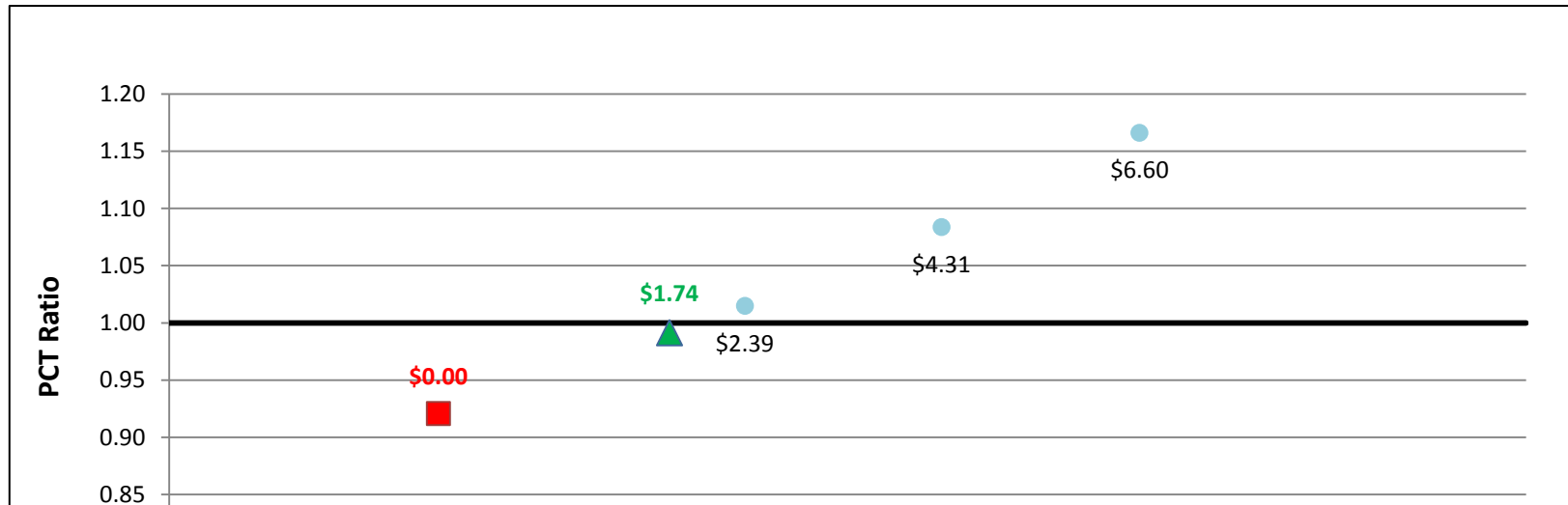


SGIP Cost Effectiveness Report
Participant Test Results (PCT)
MIRR Graphs

FC500kW w/ Natural Gas - Commercial - PG&E

	Rebate (\$/watt)	MIRR	PCT-2014
▲ Actual Rebate - 2014	\$1.74	10.6%	0.99
■ No Rebate	\$0.00	9.4%	0.92
● Rebate to Reach MIRR of 5%	\$0.00	0.0%	0.00
● Rebate to Reach MIRR of 6%	\$0.00	0.0%	0.00
● Rebate to Reach MIRR of 7%	\$0.00	0.0%	0.00
● Rebate to Reach MIRR of 8%	\$0.00	0.0%	0.00
● Rebate to Reach MIRR of 9%	\$0.00	0.0%	0.00
● Rebate to Reach MIRR of 10%	\$0.00	0.0%	0.00
● Rebate to Reach MIRR of 11%	\$2.39	11.0%	1.01
● Rebate to Reach MIRR of 12%	\$4.31	12.0%	1.08
● Rebate to Reach MIRR of 13%	\$6.60	13.0%	1.17
● Rebate to Reach MIRR of 14%	\$0.00	0.0%	0.00
● Rebate to Reach MIRR of 15%	\$0.00	0.0%	0.00

System Cost per Watt: \$7.28

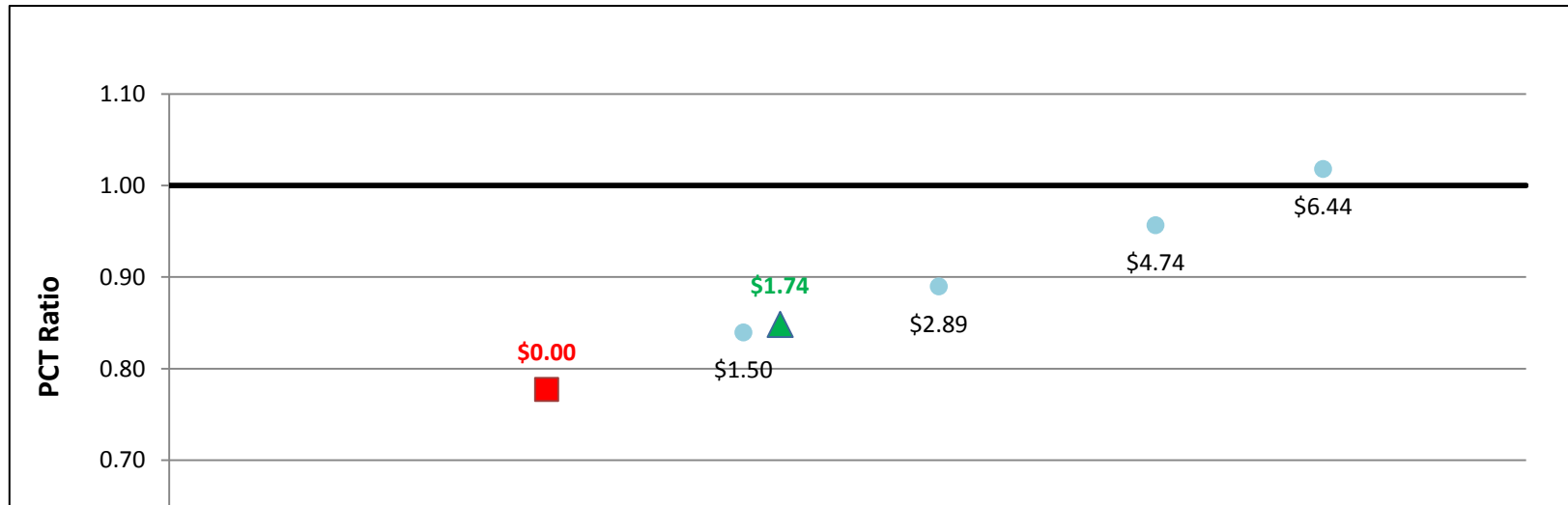


SGIP Cost Effectiveness Report
Participant Test Results (PCT)
MIRR Graphs

FC500kW w/ Natural Gas - Commercial - SCE

	Rebate (\$/watt)	MIRR	PCT-2014
▲ Actual Rebate - 2014	\$1.74	8.2%	0.85
■ No Rebate	\$0.00	6.9%	0.78
● Rebate to Reach MIRR of 5%	\$0.00	0.0%	0.00
● Rebate to Reach MIRR of 6%	\$0.00	0.0%	0.00
● Rebate to Reach MIRR of 7%	\$0.00	0.0%	0.00
● Rebate to Reach MIRR of 8%	\$1.50	8.0%	0.84
● Rebate to Reach MIRR of 9%	\$2.89	9.0%	0.89
● Rebate to Reach MIRR of 10%	\$4.74	10.1%	0.96
● Rebate to Reach MIRR of 11%	\$6.44	11.0%	1.02
● Rebate to Reach MIRR of 12%	\$0.00	0.0%	0.00
● Rebate to Reach MIRR of 13%	\$0.00	0.0%	0.00
● Rebate to Reach MIRR of 14%	\$0.00	0.0%	0.00
● Rebate to Reach MIRR of 15%	\$0.00	0.0%	0.00

System Cost per Watt: \$7.28

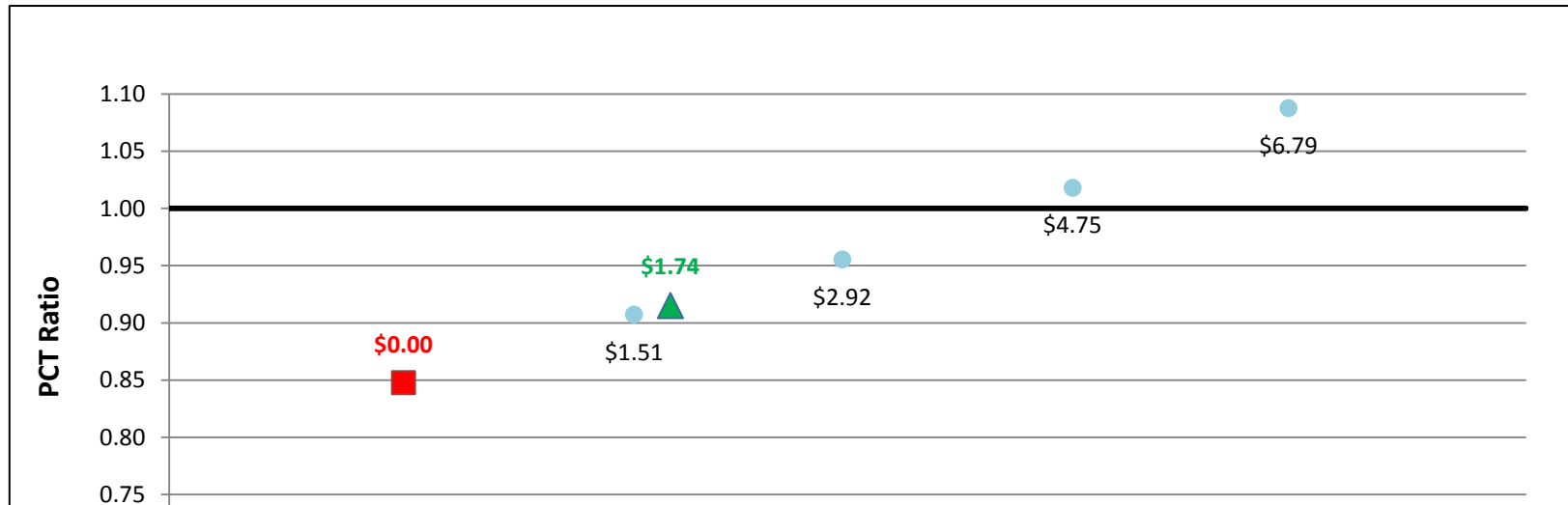


SGIP Cost Effectiveness Report
Participant Test Results (PCT)
MIRR Graphs

FC500kW w/ Natural Gas - Commercial - SDG&E

	Rebate (\$/watt)	MIRR	PCT-2014
▲ Actual Rebate - 2014	\$1.74	9.2%	0.92
■ No Rebate	\$0.00	8.0%	0.85
● Rebate to Reach MIRR of 5%	\$0.00	0.0%	0.00
● Rebate to Reach MIRR of 6%	\$0.00	0.0%	0.00
● Rebate to Reach MIRR of 7%	\$0.00	0.0%	0.00
● Rebate to Reach MIRR of 8%	\$0.00	0.0%	0.00
● Rebate to Reach MIRR of 9%	\$1.51	9.1%	0.91
● Rebate to Reach MIRR of 10%	\$2.92	10.0%	0.96
● Rebate to Reach MIRR of 11%	\$4.75	11.0%	1.02
● Rebate to Reach MIRR of 12%	\$6.79	11.9%	1.09
● Rebate to Reach MIRR of 13%	\$0.00	0.0%	0.00
● Rebate to Reach MIRR of 14%	\$0.00	0.0%	0.00
● Rebate to Reach MIRR of 15%	\$0.00	0.0%	0.00

System Cost per Watt: \$7.28

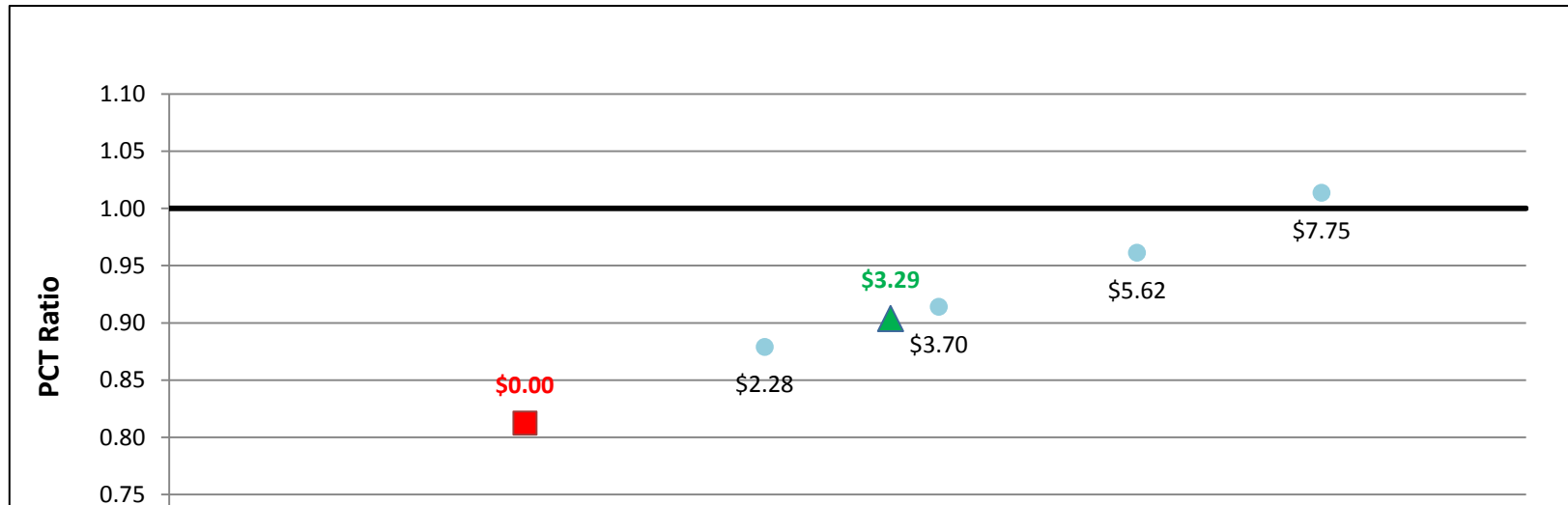


SGIP Cost Effectiveness Report
Participant Test Results (PCT)
MIRR Graphs

FC500kW w/ On-Site BioGas - Commercial - PG&E

	Rebate (\$/watt)	MIRR	PCT-2014
▲ Actual Rebate - 2014	\$3.29	8.7%	0.90
■ No Rebate	\$0.00	6.8%	0.81
● Rebate to Reach MIRR of 5%	\$0.00	0.0%	0.00
● Rebate to Reach MIRR of 6%	\$0.00	0.0%	0.00
● Rebate to Reach MIRR of 7%	\$0.00	0.0%	0.00
● Rebate to Reach MIRR of 8%	\$2.28	8.1%	0.88
● Rebate to Reach MIRR of 9%	\$3.70	9.0%	0.91
● Rebate to Reach MIRR of 10%	\$5.62	10.0%	0.96
● Rebate to Reach MIRR of 11%	\$7.75	10.9%	1.01
● Rebate to Reach MIRR of 12%	\$0.00	0.0%	0.00
● Rebate to Reach MIRR of 13%	\$0.00	0.0%	0.00
● Rebate to Reach MIRR of 14%	\$0.00	0.0%	0.00
● Rebate to Reach MIRR of 15%	\$0.00	0.0%	0.00

System Cost per Watt: \$8.34

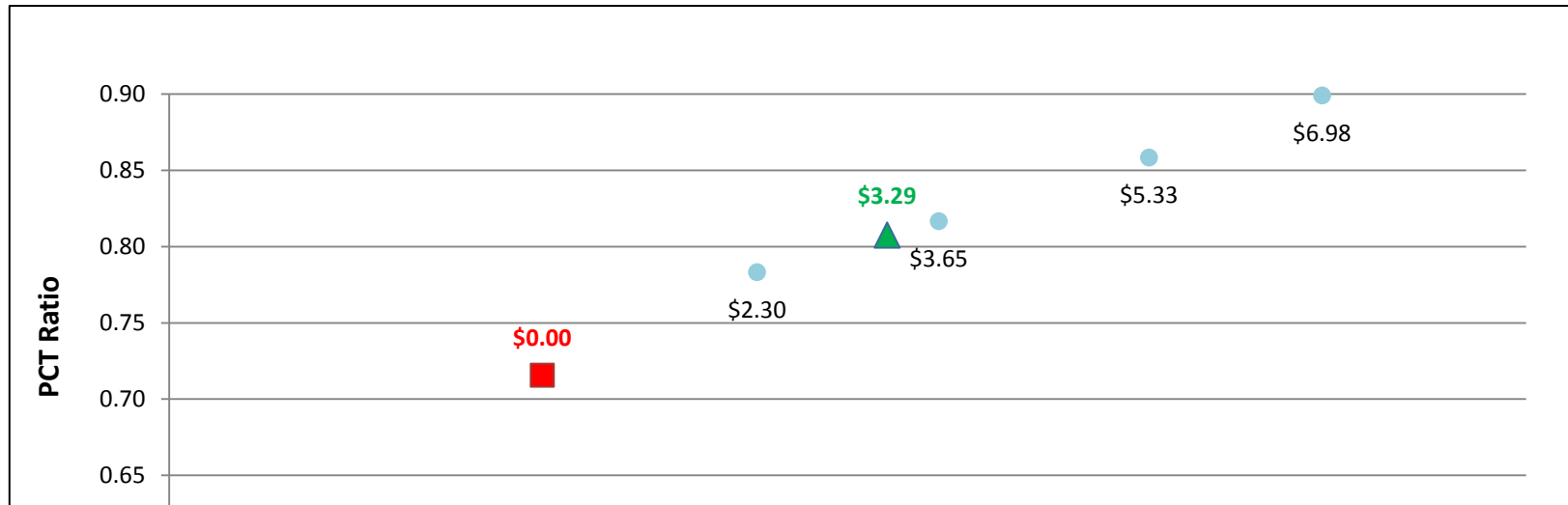


SGIP Cost Effectiveness Report
Participant Test Results (PCT)
MIRR Graphs

FC500kW w/ On-Site BioGas - Commercial - SCE

	Rebate (\$/watt)	MIRR	PCT-2014
▲ Actual Rebate - 2014	\$3.29	6.7%	0.81
■ No Rebate	\$0.00	4.9%	0.72
● Rebate to Reach MIRR of 5%	\$0.00	0.0%	0.00
● Rebate to Reach MIRR of 6%	\$2.30	6.0%	0.78
● Rebate to Reach MIRR of 7%	\$3.65	7.0%	0.82
● Rebate to Reach MIRR of 8%	\$5.33	8.1%	0.86
● Rebate to Reach MIRR of 9%	\$6.98	8.9%	0.90
● Rebate to Reach MIRR of 10%	\$0.00	0.0%	0.00
● Rebate to Reach MIRR of 11%	\$0.00	0.0%	0.00
● Rebate to Reach MIRR of 12%	\$0.00	0.0%	0.00
● Rebate to Reach MIRR of 13%	\$0.00	0.0%	0.00
● Rebate to Reach MIRR of 14%	\$0.00	0.0%	0.00
● Rebate to Reach MIRR of 15%	\$0.00	0.0%	0.00

System Cost per Watt: \$8.34

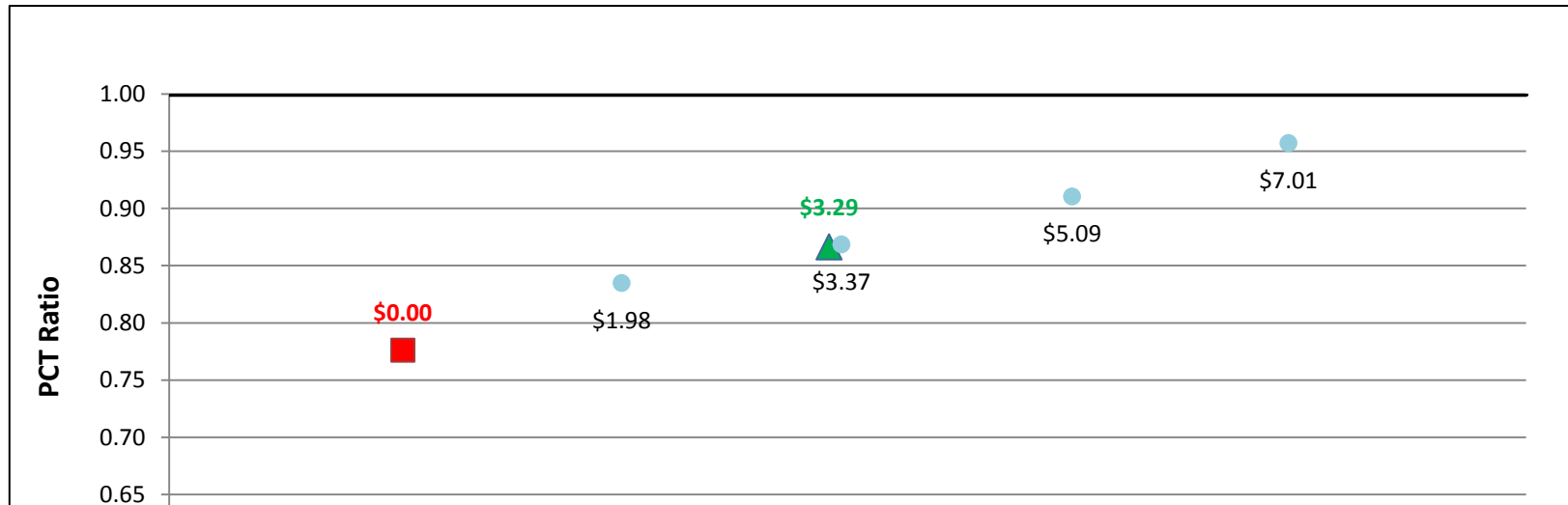


SGIP Cost Effectiveness Report
 Participant Test Results (PCT)
 MIRR Graphs

FC500kW w/ On-Site BioGas - Commercial - SDG&E

	Rebate (\$/watt)	MIRR	PCT-2014
▲ Actual Rebate - 2014	\$3.29	7.9%	0.87
■ No Rebate	\$0.00	6.0%	0.78
● Rebate to Reach MIRR of 5%	\$0.00	0.0%	0.00
● Rebate to Reach MIRR of 6%	\$0.00	0.0%	0.00
● Rebate to Reach MIRR of 7%	\$1.98	7.0%	0.83
● Rebate to Reach MIRR of 8%	\$3.37	8.0%	0.87
● Rebate to Reach MIRR of 9%	\$5.09	9.0%	0.91
● Rebate to Reach MIRR of 10%	\$7.01	9.9%	0.96
● Rebate to Reach MIRR of 11%	\$0.00	0.0%	0.00
● Rebate to Reach MIRR of 12%	\$0.00	0.0%	0.00
● Rebate to Reach MIRR of 13%	\$0.00	0.0%	0.00
● Rebate to Reach MIRR of 14%	\$0.00	0.0%	0.00
● Rebate to Reach MIRR of 15%	\$0.00	0.0%	0.00

System Cost per Watt: \$8.34

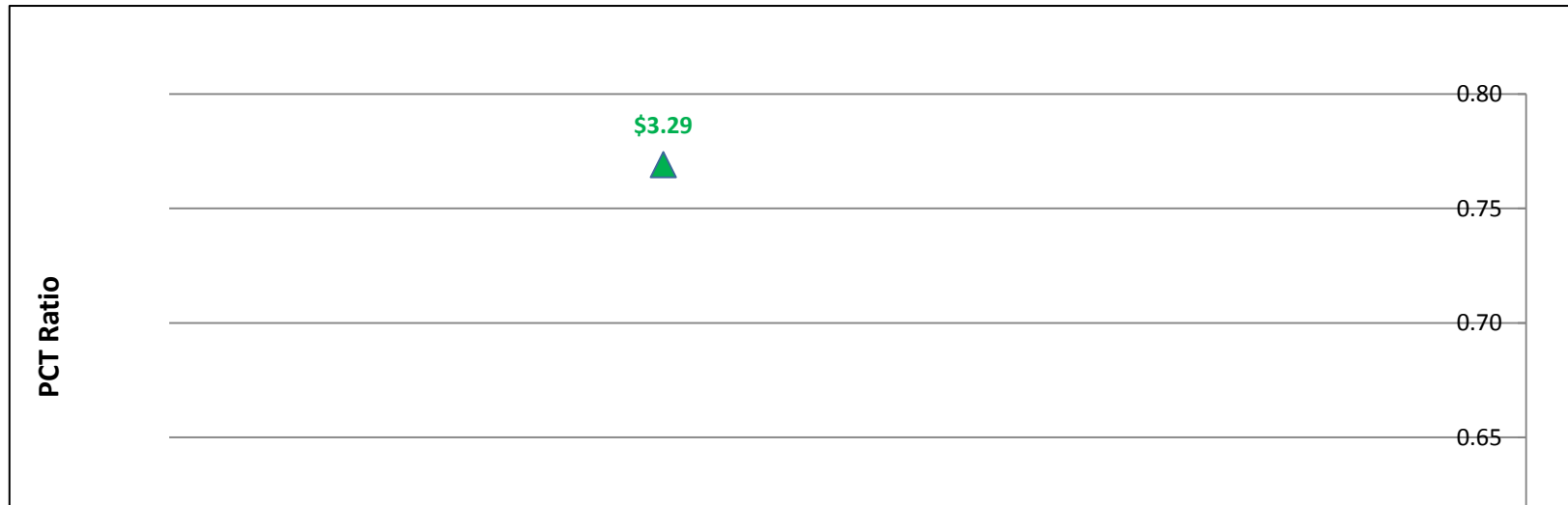


SGIP Cost Effectiveness Report
Participant Test Results (PCT)
MIRR Graphs

FC500kWe w/ Directed BioGas - Government/Non-Profit - PG&E

	Rebate (\$/watt)	MIRR	PCT-2014
▲ Actual Rebate - 2014	\$3.29	-7.9%	0.77
■ No Rebate	\$0.00	-100.0%	0.64
● Rebate to Reach MIRR of 5%	\$0.00	0.0%	0.00
● Rebate to Reach MIRR of 6%	\$0.00	0.0%	0.00
● Rebate to Reach MIRR of 7%	\$0.00	0.0%	0.00
● Rebate to Reach MIRR of 8%	\$0.00	0.0%	0.00
● Rebate to Reach MIRR of 9%	\$0.00	0.0%	0.00
● Rebate to Reach MIRR of 10%	\$0.00	0.0%	0.00
● Rebate to Reach MIRR of 11%	\$0.00	0.0%	0.00
● Rebate to Reach MIRR of 12%	\$0.00	0.0%	0.00
● Rebate to Reach MIRR of 13%	\$0.00	0.0%	0.00
● Rebate to Reach MIRR of 14%	\$0.00	0.0%	0.00
● Rebate to Reach MIRR of 15%	\$0.00	0.0%	0.00

System Cost per Watt: \$7.28



SGIP Cost Effectiveness Report
Participant Test Results (PCT)
MIRR Graphs

FC500kWe w/ Directed BioGas - Government/Non-Profit - SCE

	Rebate (\$/watt)	MIRR	PCT-2014
▲ Actual Rebate - 2014	\$3.29	-100.0%	0.57
■ No Rebate	\$0.00	-100.0%	0.44
● Rebate to Reach MIRR of 5%	\$0.00	0.0%	0.00
● Rebate to Reach MIRR of 6%	\$0.00	0.0%	0.00
● Rebate to Reach MIRR of 7%	\$0.00	0.0%	0.00
● Rebate to Reach MIRR of 8%	\$0.00	0.0%	0.00
● Rebate to Reach MIRR of 9%	\$0.00	0.0%	0.00
● Rebate to Reach MIRR of 10%	\$0.00	0.0%	0.00
● Rebate to Reach MIRR of 11%	\$0.00	0.0%	0.00
● Rebate to Reach MIRR of 12%	\$0.00	0.0%	0.00
● Rebate to Reach MIRR of 13%	\$0.00	0.0%	0.00
● Rebate to Reach MIRR of 14%	\$0.00	0.0%	0.00
● Rebate to Reach MIRR of 15%	\$0.00	0.0%	0.00

System Cost per Watt: \$7.28



SGIP Cost Effectiveness Report
Participant Test Results (PCT)
MIRR Graphs

FC500kWe w/ Directed BioGas - Government/Non-Profit - SDG&E

	Rebate (\$/watt)	MIRR	PCT-2014
▲ Actual Rebate - 2014	\$3.29	-21.9%	0.68
■ No Rebate	\$0.00	-100.0%	0.55
● Rebate to Reach MIRR of 5%	\$0.00	0.0%	0.00
● Rebate to Reach MIRR of 6%	\$0.00	0.0%	0.00
● Rebate to Reach MIRR of 7%	\$0.00	0.0%	0.00
● Rebate to Reach MIRR of 8%	\$0.00	0.0%	0.00
● Rebate to Reach MIRR of 9%	\$0.00	0.0%	0.00
● Rebate to Reach MIRR of 10%	\$0.00	0.0%	0.00
● Rebate to Reach MIRR of 11%	\$0.00	0.0%	0.00
● Rebate to Reach MIRR of 12%	\$0.00	0.0%	0.00
● Rebate to Reach MIRR of 13%	\$0.00	0.0%	0.00
● Rebate to Reach MIRR of 14%	\$0.00	0.0%	0.00
● Rebate to Reach MIRR of 15%	\$0.00	0.0%	0.00

System Cost per Watt: \$7.28

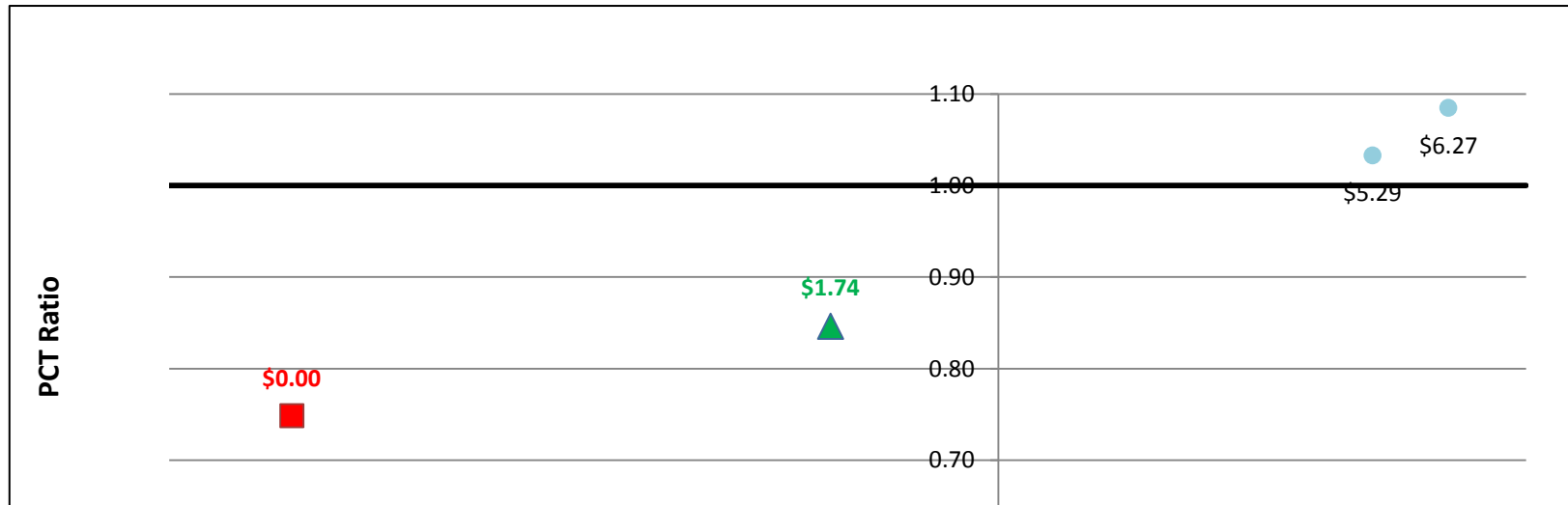


SGIP Cost Effectiveness Report
Participant Test Results (PCT)
MIRR Graphs

FC500kWe w/ Natural Gas - Government/Non-Profit - PG&E

	Rebate (\$/watt)	MIRR	PCT-2014
▲ Actual Rebate - 2014	\$1.74	-2.2%	0.85
■ No Rebate	\$0.00	-9.4%	0.75
● Rebate to Reach MIRR of 5%	\$5.29	5.0%	1.03
● Rebate to Reach MIRR of 6%	\$6.27	6.0%	1.08
● Rebate to Reach MIRR of 7%	\$0.00	0.0%	0.00
● Rebate to Reach MIRR of 8%	\$0.00	0.0%	0.00
● Rebate to Reach MIRR of 9%	\$0.00	0.0%	0.00
● Rebate to Reach MIRR of 10%	\$0.00	0.0%	0.00
● Rebate to Reach MIRR of 11%	\$0.00	0.0%	0.00
● Rebate to Reach MIRR of 12%	\$0.00	0.0%	0.00
● Rebate to Reach MIRR of 13%	\$0.00	0.0%	0.00
● Rebate to Reach MIRR of 14%	\$0.00	0.0%	0.00
● Rebate to Reach MIRR of 15%	\$0.00	0.0%	0.00

System Cost per Watt: \$7.28



SGIP Cost Effectiveness Report
 Participant Test Results (PCT)
 MIRR Graphs

FC500kWe w/ Natural Gas - Government/Non-Profit - SCE

	Rebate (\$/watt)	MIRR	PCT-2014
▲ Actual Rebate - 2014	\$1.74	-100.0%	0.57
■ No Rebate	\$0.00	-100.0%	0.47
● Rebate to Reach MIRR of 5%	\$0.00	0.0%	0.00
● Rebate to Reach MIRR of 6%	\$0.00	0.0%	0.00
● Rebate to Reach MIRR of 7%	\$0.00	0.0%	0.00
● Rebate to Reach MIRR of 8%	\$0.00	0.0%	0.00
● Rebate to Reach MIRR of 9%	\$0.00	0.0%	0.00
● Rebate to Reach MIRR of 10%	\$0.00	0.0%	0.00
● Rebate to Reach MIRR of 11%	\$0.00	0.0%	0.00
● Rebate to Reach MIRR of 12%	\$0.00	0.0%	0.00
● Rebate to Reach MIRR of 13%	\$0.00	0.0%	0.00
● Rebate to Reach MIRR of 14%	\$0.00	0.0%	0.00
● Rebate to Reach MIRR of 15%	\$0.00	0.0%	0.00

System Cost per Watt: \$7.28

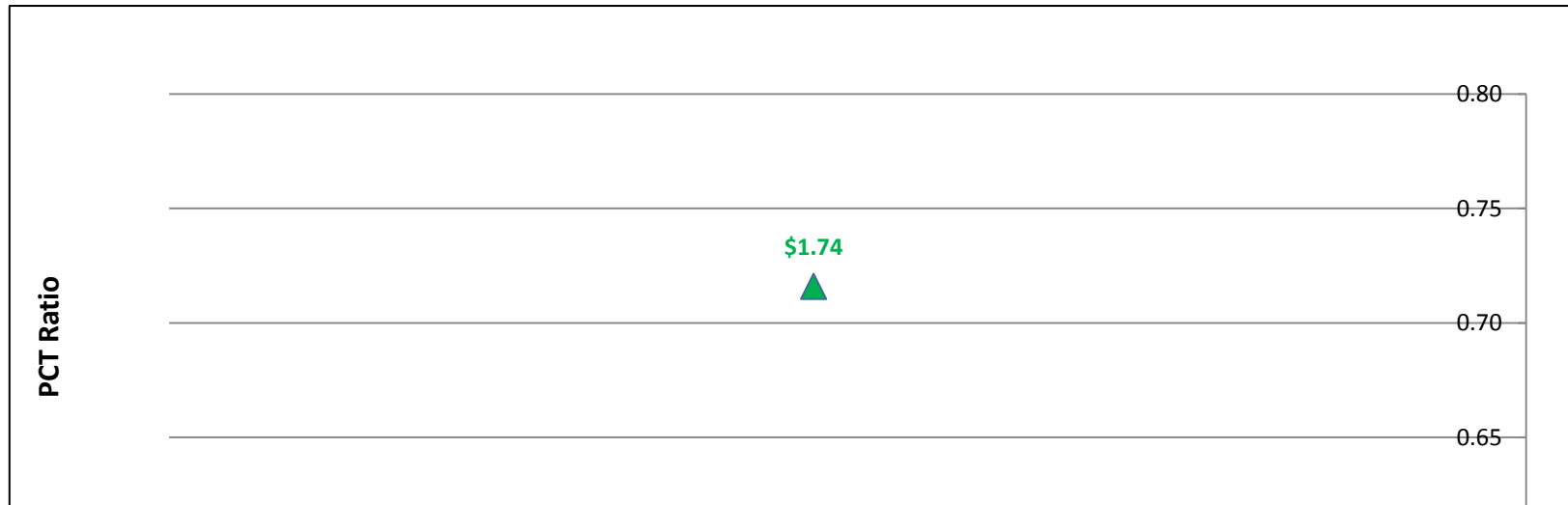


SGIP Cost Effectiveness Report
Participant Test Results (PCT)
MIRR Graphs

FC500kWe w/ Natural Gas - Government/Non-Profit - SDG&E

	Rebate (\$/watt)	MIRR	PCT-2014
▲ Actual Rebate - 2014	\$1.74	-11.6%	0.72
■ No Rebate	\$0.00	-100.0%	0.62
● Rebate to Reach MIRR of 5%	\$0.00	0.0%	0.00
● Rebate to Reach MIRR of 6%	\$0.00	0.0%	0.00
● Rebate to Reach MIRR of 7%	\$0.00	0.0%	0.00
● Rebate to Reach MIRR of 8%	\$0.00	0.0%	0.00
● Rebate to Reach MIRR of 9%	\$0.00	0.0%	0.00
● Rebate to Reach MIRR of 10%	\$0.00	0.0%	0.00
● Rebate to Reach MIRR of 11%	\$0.00	0.0%	0.00
● Rebate to Reach MIRR of 12%	\$0.00	0.0%	0.00
● Rebate to Reach MIRR of 13%	\$0.00	0.0%	0.00
● Rebate to Reach MIRR of 14%	\$0.00	0.0%	0.00
● Rebate to Reach MIRR of 15%	\$0.00	0.0%	0.00

System Cost per Watt: \$7.28



SGIP Cost Effectiveness Report
Participant Test Results (PCT)
MIRR Graphs

FC500kWe w/ On-Site BioGas - Government/Non-Profit - PG&E

	Rebate (\$/watt)	MIRR	PCT-2014
▲ Actual Rebate - 2014	\$3.29	-17.4%	0.67
■ No Rebate	\$0.00	-100.0%	0.55
● Rebate to Reach MIRR of 5%	\$0.00	0.0%	0.00
● Rebate to Reach MIRR of 6%	\$0.00	0.0%	0.00
● Rebate to Reach MIRR of 7%	\$0.00	0.0%	0.00
● Rebate to Reach MIRR of 8%	\$0.00	0.0%	0.00
● Rebate to Reach MIRR of 9%	\$0.00	0.0%	0.00
● Rebate to Reach MIRR of 10%	\$0.00	0.0%	0.00
● Rebate to Reach MIRR of 11%	\$0.00	0.0%	0.00
● Rebate to Reach MIRR of 12%	\$0.00	0.0%	0.00
● Rebate to Reach MIRR of 13%	\$0.00	0.0%	0.00
● Rebate to Reach MIRR of 14%	\$0.00	0.0%	0.00
● Rebate to Reach MIRR of 15%	\$0.00	0.0%	0.00

System Cost per Watt: \$8.34



SGIP Cost Effectiveness Report
Participant Test Results (PCT)
MIRR Graphs

FC500kWe w/ On-Site BioGas - Government/Non-Profit - SCE

	Rebate (\$/watt)	MIRR	PCT-2014
▲ Actual Rebate - 2014	\$3.29	-100.0%	0.50
■ No Rebate	\$0.00	-100.0%	0.38
● Rebate to Reach MIRR of 5%	\$0.00	0.0%	0.00
● Rebate to Reach MIRR of 6%	\$0.00	0.0%	0.00
● Rebate to Reach MIRR of 7%	\$0.00	0.0%	0.00
● Rebate to Reach MIRR of 8%	\$0.00	0.0%	0.00
● Rebate to Reach MIRR of 9%	\$0.00	0.0%	0.00
● Rebate to Reach MIRR of 10%	\$0.00	0.0%	0.00
● Rebate to Reach MIRR of 11%	\$0.00	0.0%	0.00
● Rebate to Reach MIRR of 12%	\$0.00	0.0%	0.00
● Rebate to Reach MIRR of 13%	\$0.00	0.0%	0.00
● Rebate to Reach MIRR of 14%	\$0.00	0.0%	0.00
● Rebate to Reach MIRR of 15%	\$0.00	0.0%	0.00

System Cost per Watt: \$8.34



SGIP Cost Effectiveness Report
Participant Test Results (PCT)
MIRR Graphs

FC500kWe w/ On-Site BioGas - Government/Non-Profit - SDG&E

	Rebate (\$/watt)	MIRR	PCT-2014
▲ Actual Rebate - 2014	\$3.29	-100.0%	0.61
■ No Rebate	\$0.00	-100.0%	0.49
● Rebate to Reach MIRR of 5%	\$0.00	0.0%	0.00
● Rebate to Reach MIRR of 6%	\$0.00	0.0%	0.00
● Rebate to Reach MIRR of 7%	\$0.00	0.0%	0.00
● Rebate to Reach MIRR of 8%	\$0.00	0.0%	0.00
● Rebate to Reach MIRR of 9%	\$0.00	0.0%	0.00
● Rebate to Reach MIRR of 10%	\$0.00	0.0%	0.00
● Rebate to Reach MIRR of 11%	\$0.00	0.0%	0.00
● Rebate to Reach MIRR of 12%	\$0.00	0.0%	0.00
● Rebate to Reach MIRR of 13%	\$0.00	0.0%	0.00
● Rebate to Reach MIRR of 14%	\$0.00	0.0%	0.00
● Rebate to Reach MIRR of 15%	\$0.00	0.0%	0.00

System Cost per Watt: \$8.34

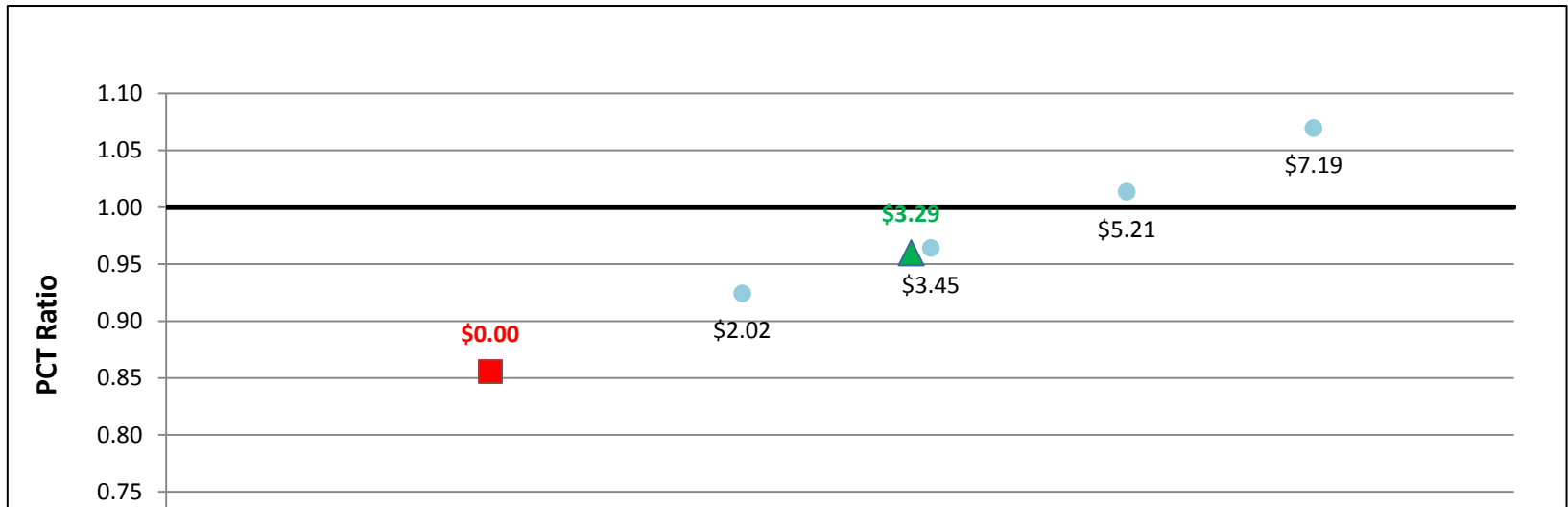


SGIP Cost Effectiveness Report
Participant Test Results (PCT)
MIRR Graphs

FC500kWe w/ Directed BioGas - Commercial - PG&E

	Rebate (\$/watt)	MIRR	PCT-2014
▲ Actual Rebate - 2014	\$3.29	9.9%	0.96
■ No Rebate	\$0.00	7.7%	0.86
● Rebate to Reach MIRR of 5%	\$0.00	0.0%	0.00
● Rebate to Reach MIRR of 6%	\$0.00	0.0%	0.00
● Rebate to Reach MIRR of 7%	\$0.00	0.0%	0.00
● Rebate to Reach MIRR of 8%	\$0.00	0.0%	0.00
● Rebate to Reach MIRR of 9%	\$2.02	9.0%	0.92
● Rebate to Reach MIRR of 10%	\$3.45	10.0%	0.96
● Rebate to Reach MIRR of 11%	\$5.21	11.0%	1.01
● Rebate to Reach MIRR of 12%	\$7.19	12.0%	1.07
● Rebate to Reach MIRR of 13%	\$0.00	0.0%	0.00
● Rebate to Reach MIRR of 14%	\$0.00	0.0%	0.00
● Rebate to Reach MIRR of 15%	\$0.00	0.0%	0.00

System Cost per Watt: \$7.28

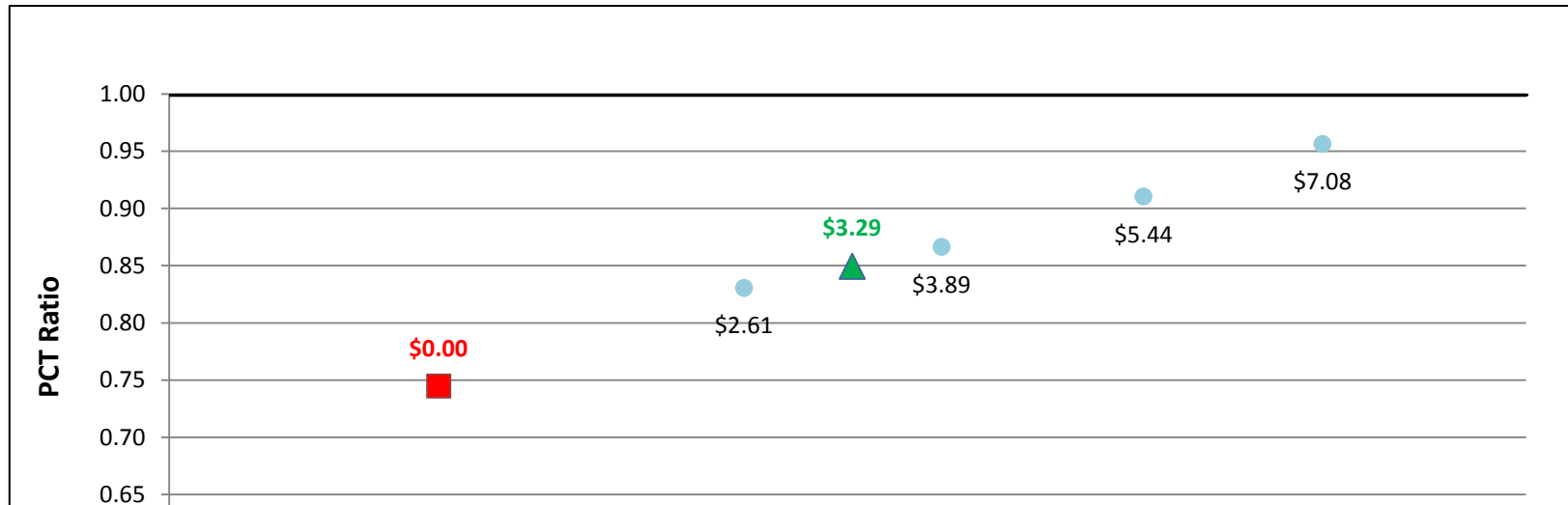


SGIP Cost Effectiveness Report
Participant Test Results (PCT)
MIRR Graphs

FC500kWe w/ Directed BioGas - Commercial - SCE

	Rebate (\$/watt)	MIRR	PCT-2014
▲ Actual Rebate - 2014	\$3.29	7.5%	0.85
■ No Rebate	\$0.00	5.4%	0.74
● Rebate to Reach MIRR of 5%	\$0.00	0.0%	0.00
● Rebate to Reach MIRR of 6%	\$0.00	0.0%	0.00
● Rebate to Reach MIRR of 7%	\$2.61	7.0%	0.83
● Rebate to Reach MIRR of 8%	\$3.89	8.0%	0.87
● Rebate to Reach MIRR of 9%	\$5.44	9.0%	0.91
● Rebate to Reach MIRR of 10%	\$7.08	9.9%	0.96
● Rebate to Reach MIRR of 11%	\$0.00	0.0%	0.00
● Rebate to Reach MIRR of 12%	\$0.00	0.0%	0.00
● Rebate to Reach MIRR of 13%	\$0.00	0.0%	0.00
● Rebate to Reach MIRR of 14%	\$0.00	0.0%	0.00
● Rebate to Reach MIRR of 15%	\$0.00	0.0%	0.00

System Cost per Watt: \$7.28

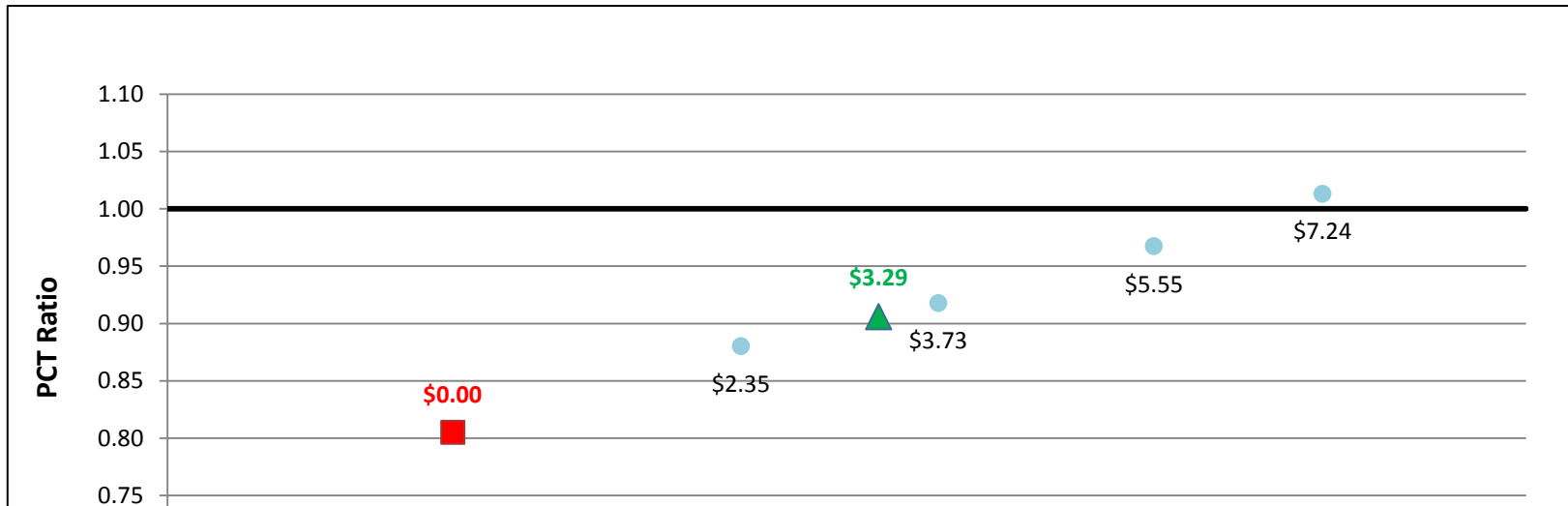


SGIP Cost Effectiveness Report
Participant Test Results (PCT)
MIRR Graphs

FC500kWe w/ Directed BioGas - Commercial - SDG&E

	Rebate (\$/watt)	MIRR	PCT-2014
▲ Actual Rebate - 2014	\$3.29	8.7%	0.91
■ No Rebate	\$0.00	6.5%	0.80
● Rebate to Reach MIRR of 5%	\$0.00	0.0%	0.00
● Rebate to Reach MIRR of 6%	\$0.00	0.0%	0.00
● Rebate to Reach MIRR of 7%	\$0.00	0.0%	0.00
● Rebate to Reach MIRR of 8%	\$2.35	8.0%	0.88
● Rebate to Reach MIRR of 9%	\$3.73	9.0%	0.92
● Rebate to Reach MIRR of 10%	\$5.55	10.1%	0.97
● Rebate to Reach MIRR of 11%	\$7.24	11.0%	1.01
● Rebate to Reach MIRR of 12%	\$0.00	0.0%	0.00
● Rebate to Reach MIRR of 13%	\$0.00	0.0%	0.00
● Rebate to Reach MIRR of 14%	\$0.00	0.0%	0.00
● Rebate to Reach MIRR of 15%	\$0.00	0.0%	0.00

System Cost per Watt: \$7.28

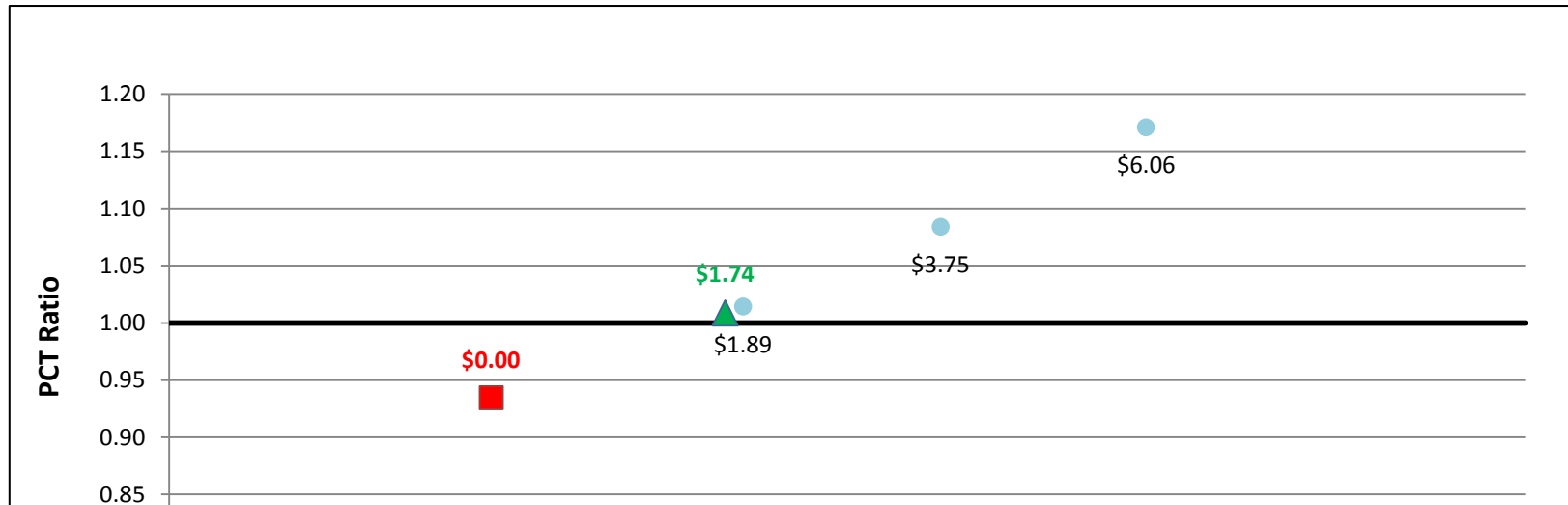


SGIP Cost Effectiveness Report
Participant Test Results (PCT)
MIRR Graphs

FC500kWe w/ Natural Gas - Commercial - PG&E

	Rebate (\$/watt)	MIRR	PCT-2014
▲ Actual Rebate - 2014	\$1.74	10.9%	1.01
■ No Rebate	\$0.00	9.7%	0.93
● Rebate to Reach MIRR of 5%	\$0.00	0.0%	0.00
● Rebate to Reach MIRR of 6%	\$0.00	0.0%	0.00
● Rebate to Reach MIRR of 7%	\$0.00	0.0%	0.00
● Rebate to Reach MIRR of 8%	\$0.00	0.0%	0.00
● Rebate to Reach MIRR of 9%	\$0.00	0.0%	0.00
● Rebate to Reach MIRR of 10%	\$0.00	0.0%	0.00
● Rebate to Reach MIRR of 11%	\$1.89	11.0%	1.01
● Rebate to Reach MIRR of 12%	\$3.75	12.0%	1.08
● Rebate to Reach MIRR of 13%	\$6.06	13.0%	1.17
● Rebate to Reach MIRR of 14%	\$0.00	0.0%	0.00
● Rebate to Reach MIRR of 15%	\$0.00	0.0%	0.00

System Cost per Watt: \$7.28

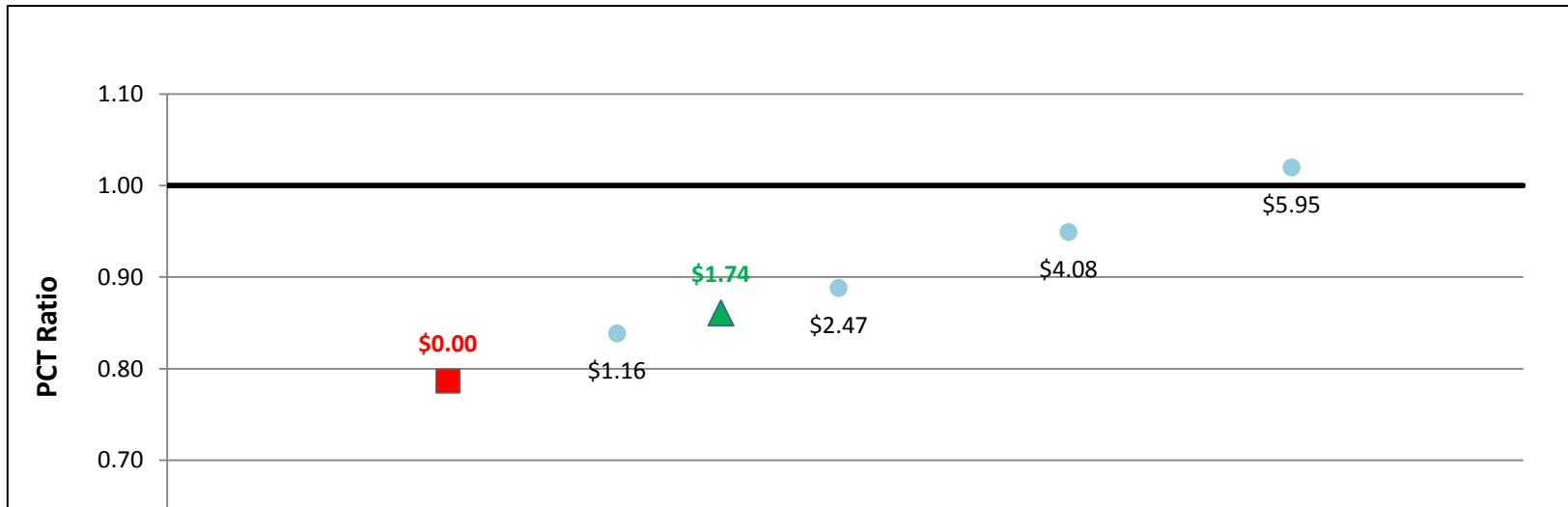


SGIP Cost Effectiveness Report
Participant Test Results (PCT)
MIRR Graphs

FC500kWe w/ Natural Gas - Commercial - SCE

	Rebate (\$/watt)	MIRR	PCT-2014
▲ Actual Rebate - 2014	\$1.74	8.5%	0.86
■ No Rebate	\$0.00	7.2%	0.79
● Rebate to Reach MIRR of 5%	\$0.00	0.0%	0.00
● Rebate to Reach MIRR of 6%	\$0.00	0.0%	0.00
● Rebate to Reach MIRR of 7%	\$0.00	0.0%	0.00
● Rebate to Reach MIRR of 8%	\$1.16	8.0%	0.84
● Rebate to Reach MIRR of 9%	\$2.47	9.0%	0.89
● Rebate to Reach MIRR of 10%	\$4.08	10.0%	0.95
● Rebate to Reach MIRR of 11%	\$5.95	11.0%	1.02
● Rebate to Reach MIRR of 12%	\$0.00	0.0%	0.00
● Rebate to Reach MIRR of 13%	\$0.00	0.0%	0.00
● Rebate to Reach MIRR of 14%	\$0.00	0.0%	0.00
● Rebate to Reach MIRR of 15%	\$0.00	0.0%	0.00

System Cost per Watt: \$7.28

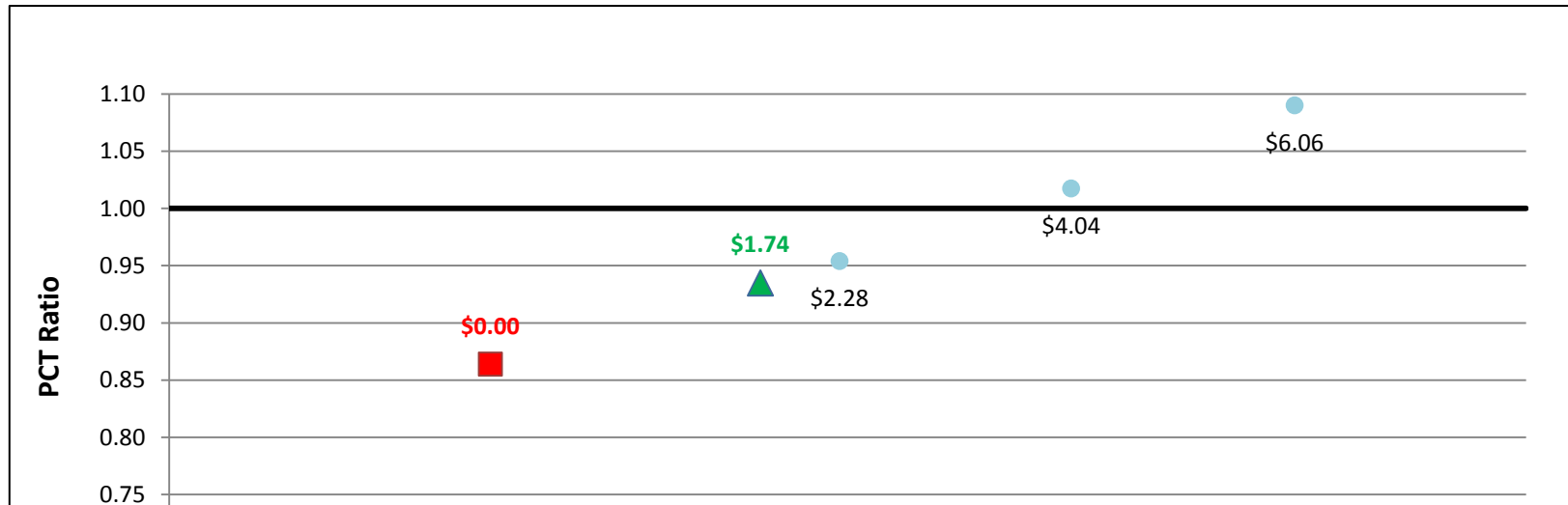


SGIP Cost Effectiveness Report
Participant Test Results (PCT)
MIRR Graphs

FC500kWe w/ Natural Gas - Commercial - SDG&E

	Rebate (\$/watt)	MIRR	PCT-2014
▲ Actual Rebate - 2014	\$1.74	9.6%	0.93
■ No Rebate	\$0.00	8.4%	0.86
● Rebate to Reach MIRR of 5%	\$0.00	0.0%	0.00
● Rebate to Reach MIRR of 6%	\$0.00	0.0%	0.00
● Rebate to Reach MIRR of 7%	\$0.00	0.0%	0.00
● Rebate to Reach MIRR of 8%	\$0.00	0.0%	0.00
● Rebate to Reach MIRR of 9%	\$0.00	0.0%	0.00
● Rebate to Reach MIRR of 10%	\$2.28	10.0%	0.95
● Rebate to Reach MIRR of 11%	\$4.04	11.0%	1.02
● Rebate to Reach MIRR of 12%	\$6.06	12.0%	1.09
● Rebate to Reach MIRR of 13%	\$0.00	0.0%	0.00
● Rebate to Reach MIRR of 14%	\$0.00	0.0%	0.00
● Rebate to Reach MIRR of 15%	\$0.00	0.0%	0.00

System Cost per Watt: \$7.28

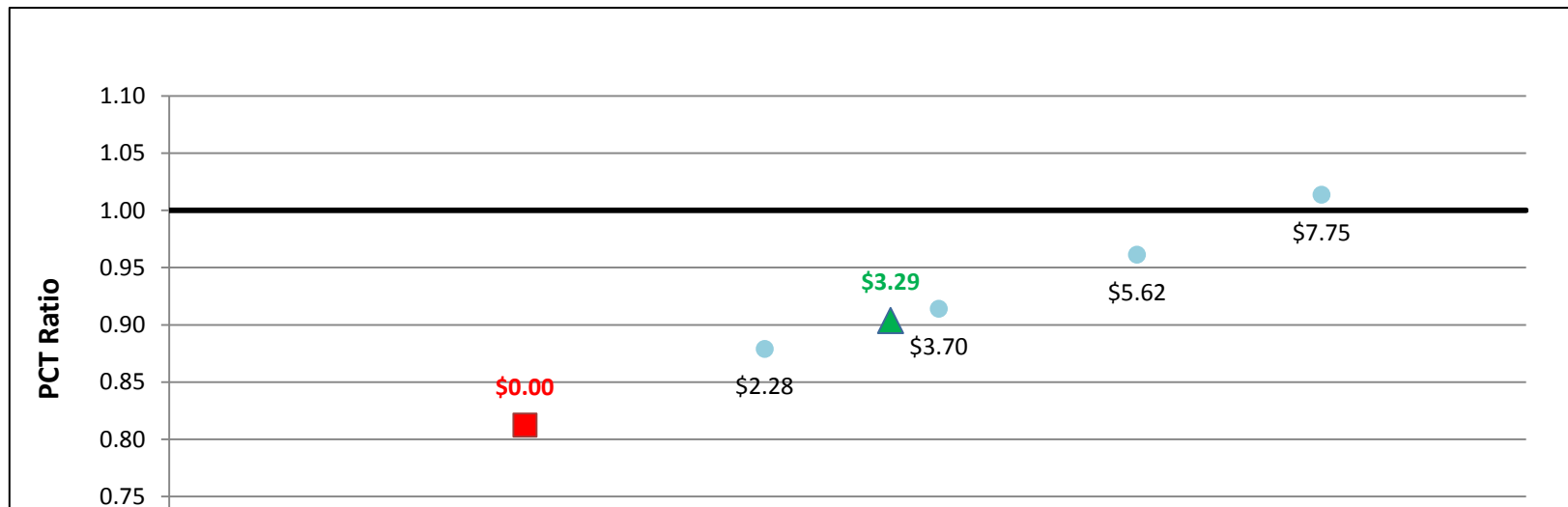


SGIP Cost Effectiveness Report
Participant Test Results (PCT)
MIRR Graphs

FC500kWe w/ On-Site BioGas - Commercial - PG&E

	Rebate (\$/watt)	MIRR	PCT-2014
▲ Actual Rebate - 2014	\$3.29	8.7%	0.90
■ No Rebate	\$0.00	6.8%	0.81
● Rebate to Reach MIRR of 5%	\$0.00	0.0%	0.00
● Rebate to Reach MIRR of 6%	\$0.00	0.0%	0.00
● Rebate to Reach MIRR of 7%	\$0.00	0.0%	0.00
● Rebate to Reach MIRR of 8%	\$2.28	8.1%	0.88
● Rebate to Reach MIRR of 9%	\$3.70	9.0%	0.91
● Rebate to Reach MIRR of 10%	\$5.62	10.0%	0.96
● Rebate to Reach MIRR of 11%	\$7.75	10.9%	1.01
● Rebate to Reach MIRR of 12%	\$0.00	0.0%	0.00
● Rebate to Reach MIRR of 13%	\$0.00	0.0%	0.00
● Rebate to Reach MIRR of 14%	\$0.00	0.0%	0.00
● Rebate to Reach MIRR of 15%	\$0.00	0.0%	0.00

System Cost per Watt: \$8.34

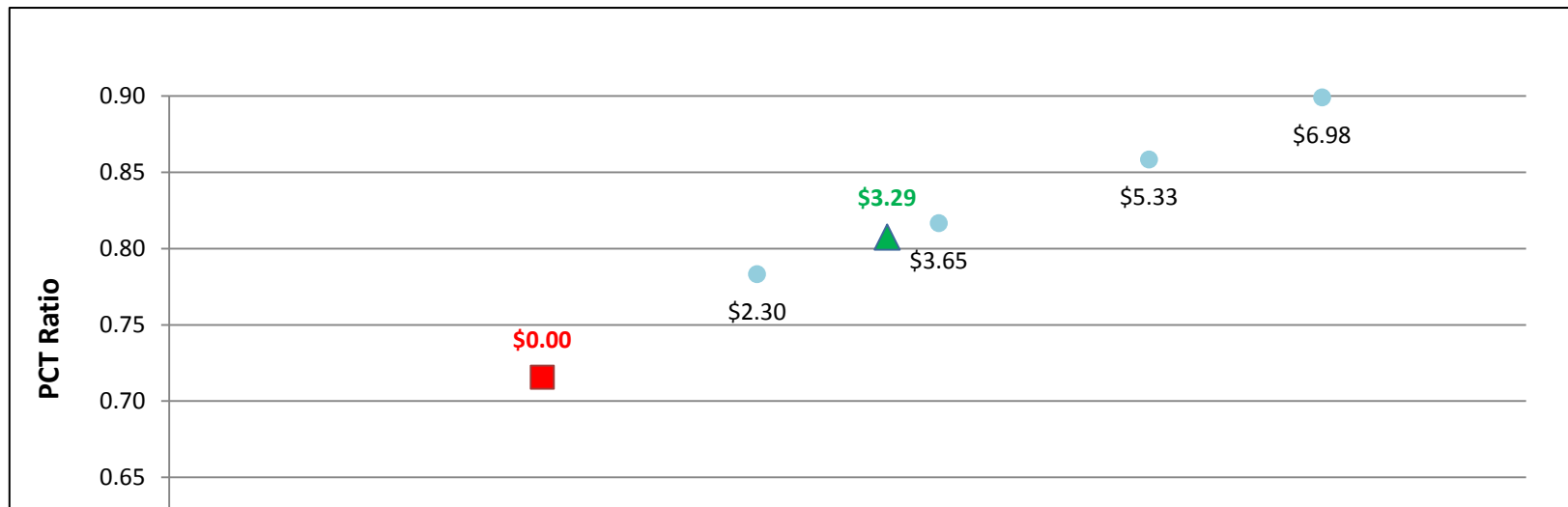


SGIP Cost Effectiveness Report
 Participant Test Results (PCT)
 MIRR Graphs

FC500kWe w/ On-Site BioGas - Commercial - SCE

	Rebate (\$/watt)	MIRR	PCT-2014
▲ Actual Rebate - 2014	\$3.29	6.7%	0.81
■ No Rebate	\$0.00	4.9%	0.72
● Rebate to Reach MIRR of 5%	\$0.00	0.0%	0.00
● Rebate to Reach MIRR of 6%	\$2.30	6.0%	0.78
● Rebate to Reach MIRR of 7%	\$3.65	7.0%	0.82
● Rebate to Reach MIRR of 8%	\$5.33	8.1%	0.86
● Rebate to Reach MIRR of 9%	\$6.98	8.9%	0.90
● Rebate to Reach MIRR of 10%	\$0.00	0.0%	0.00
● Rebate to Reach MIRR of 11%	\$0.00	0.0%	0.00
● Rebate to Reach MIRR of 12%	\$0.00	0.0%	0.00
● Rebate to Reach MIRR of 13%	\$0.00	0.0%	0.00
● Rebate to Reach MIRR of 14%	\$0.00	0.0%	0.00
● Rebate to Reach MIRR of 15%	\$0.00	0.0%	0.00

System Cost per Watt: \$8.34

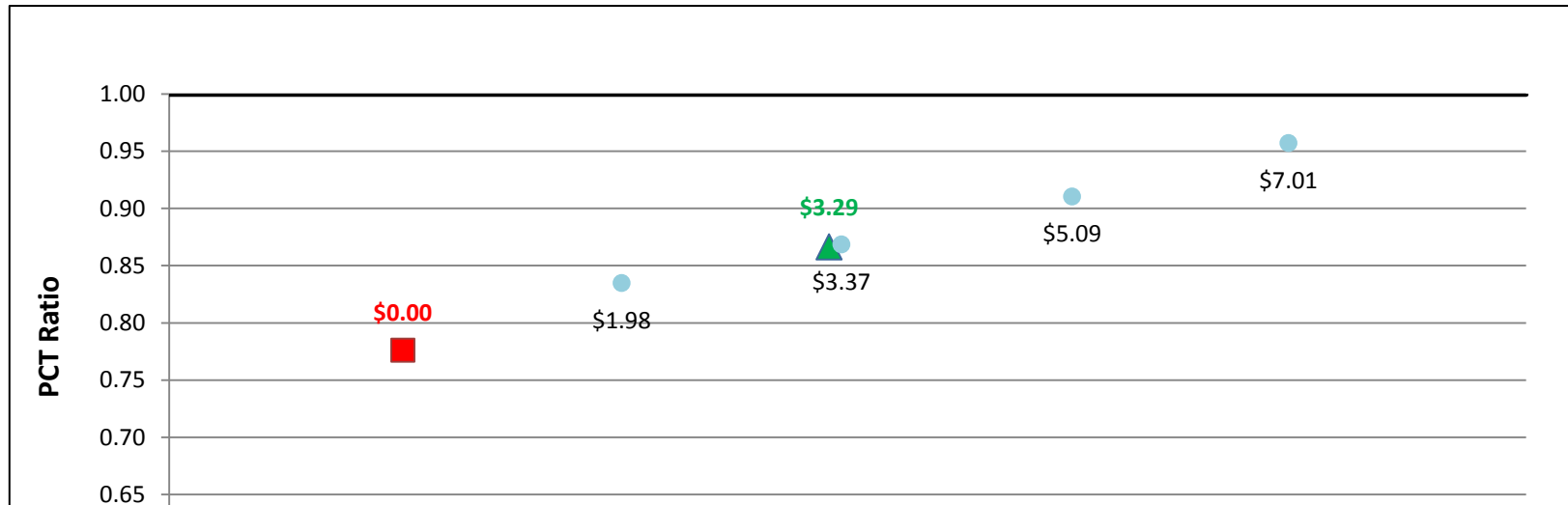


SGIP Cost Effectiveness Report
Participant Test Results (PCT)
MIRR Graphs

FC500kWe w/ On-Site BioGas - Commercial - SDG&E

	Rebate (\$/watt)	MIRR	PCT-2014
▲ Actual Rebate - 2014	\$3.29	7.9%	0.87
■ No Rebate	\$0.00	6.0%	0.78
● Rebate to Reach MIRR of 5%	\$0.00	0.0%	0.00
● Rebate to Reach MIRR of 6%	\$0.00	0.0%	0.00
● Rebate to Reach MIRR of 7%	\$1.98	7.0%	0.83
● Rebate to Reach MIRR of 8%	\$3.37	8.0%	0.87
● Rebate to Reach MIRR of 9%	\$5.09	9.0%	0.91
● Rebate to Reach MIRR of 10%	\$7.01	9.9%	0.96
● Rebate to Reach MIRR of 11%	\$0.00	0.0%	0.00
● Rebate to Reach MIRR of 12%	\$0.00	0.0%	0.00
● Rebate to Reach MIRR of 13%	\$0.00	0.0%	0.00
● Rebate to Reach MIRR of 14%	\$0.00	0.0%	0.00
● Rebate to Reach MIRR of 15%	\$0.00	0.0%	0.00

System Cost per Watt: \$8.34





Pressure Reduction Turbines



SGIP Cost Effectiveness Report
Participant Test Results (PCT)
MIRR Graphs

PRT - Government/Non-Profit - PG&E

	Rebate (\$/watt)	MIRR	PCT-2014
▲ Actual Rebate - 2014	\$1.08	17.1%	2.63
■ No Rebate	\$0.00	14.5%	2.46
● Rebate to Reach MIRR of 5%	\$0.00	0.0%	0.00
● Rebate to Reach MIRR of 6%	\$0.00	0.0%	0.00
● Rebate to Reach MIRR of 7%	\$0.00	0.0%	0.00
● Rebate to Reach MIRR of 8%	\$0.00	0.0%	0.00
● Rebate to Reach MIRR of 9%	\$0.00	0.0%	0.00
● Rebate to Reach MIRR of 10%	\$0.00	0.0%	0.00
● Rebate to Reach MIRR of 11%	\$0.00	0.0%	0.00
● Rebate to Reach MIRR of 12%	\$0.00	0.0%	0.00
● Rebate to Reach MIRR of 13%	\$0.00	0.0%	0.00
● Rebate to Reach MIRR of 14%	\$0.00	0.0%	0.00
● Rebate to Reach MIRR of 15%	\$0.00	0.0%	0.00

System Cost per Watt: \$4.14



SGIP Cost Effectiveness Report
Participant Test Results (PCT)
MIRR Graphs

PRT - Government/Non-Profit - SCE

	Rebate (\$/watt)	MIRR	PCT-2014
▲ Actual Rebate - 2014	\$1.08	13.3%	1.76
■ No Rebate	\$0.00	10.5%	1.59
● Rebate to Reach MIRR of 5%	\$0.00	0.0%	0.00
● Rebate to Reach MIRR of 6%	\$0.00	0.0%	0.00
● Rebate to Reach MIRR of 7%	\$0.00	0.0%	0.00
● Rebate to Reach MIRR of 8%	\$0.00	0.0%	0.00
● Rebate to Reach MIRR of 9%	\$0.00	0.0%	0.00
● Rebate to Reach MIRR of 10%	\$0.00	0.0%	0.00
● Rebate to Reach MIRR of 11%	\$0.00	0.0%	0.00
● Rebate to Reach MIRR of 12%	\$0.00	0.0%	0.00
● Rebate to Reach MIRR of 13%	\$0.77	13.0%	1.71
● Rebate to Reach MIRR of 14%	\$1.94	14.0%	1.88
● Rebate to Reach MIRR of 15%	\$3.32	15.0%	2.08

System Cost per Watt: \$4.14

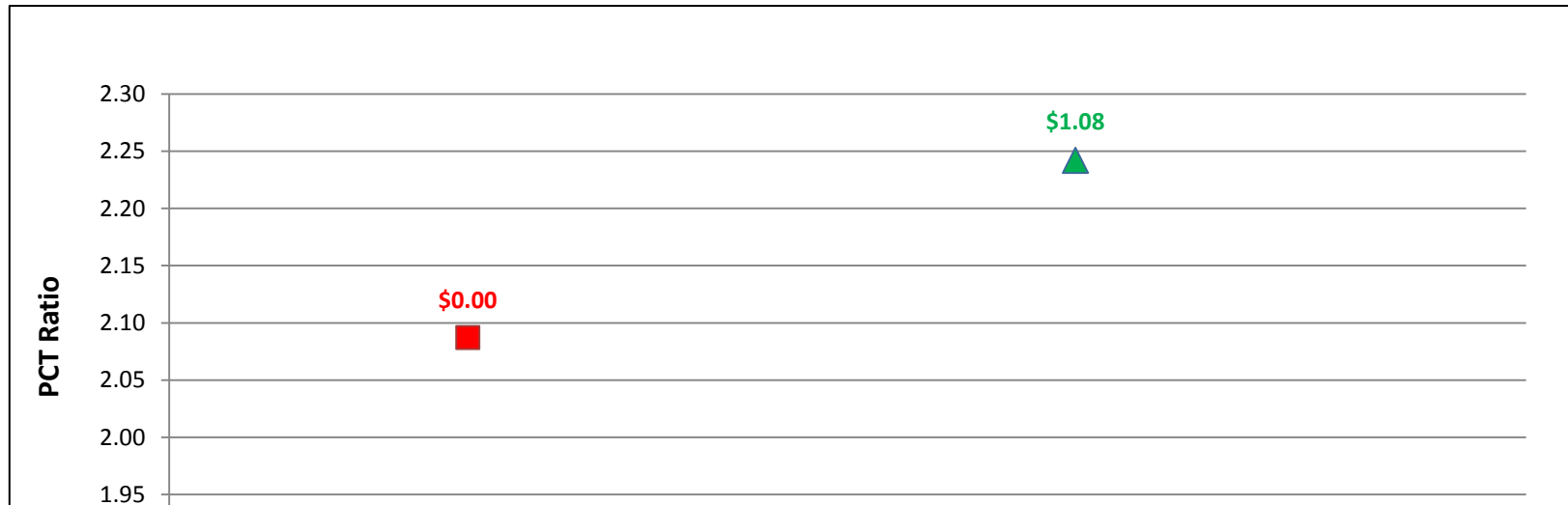


SGIP Cost Effectiveness Report
Participant Test Results (PCT)
MIRR Graphs

PRT - Government/Non-Profit - SDG&E

	Rebate (\$/watt)	MIRR	PCT-2014
▲ Actual Rebate - 2014	\$1.08	16.0%	2.24
■ No Rebate	\$0.00	13.3%	2.09
● Rebate to Reach MIRR of 5%	\$0.00	0.0%	0.00
● Rebate to Reach MIRR of 6%	\$0.00	0.0%	0.00
● Rebate to Reach MIRR of 7%	\$0.00	0.0%	0.00
● Rebate to Reach MIRR of 8%	\$0.00	0.0%	0.00
● Rebate to Reach MIRR of 9%	\$0.00	0.0%	0.00
● Rebate to Reach MIRR of 10%	\$0.00	0.0%	0.00
● Rebate to Reach MIRR of 11%	\$0.00	0.0%	0.00
● Rebate to Reach MIRR of 12%	\$0.00	0.0%	0.00
● Rebate to Reach MIRR of 13%	\$0.00	0.0%	0.00
● Rebate to Reach MIRR of 14%	\$0.00	0.0%	0.00
● Rebate to Reach MIRR of 15%	\$0.00	0.0%	0.00

System Cost per Watt: \$4.14

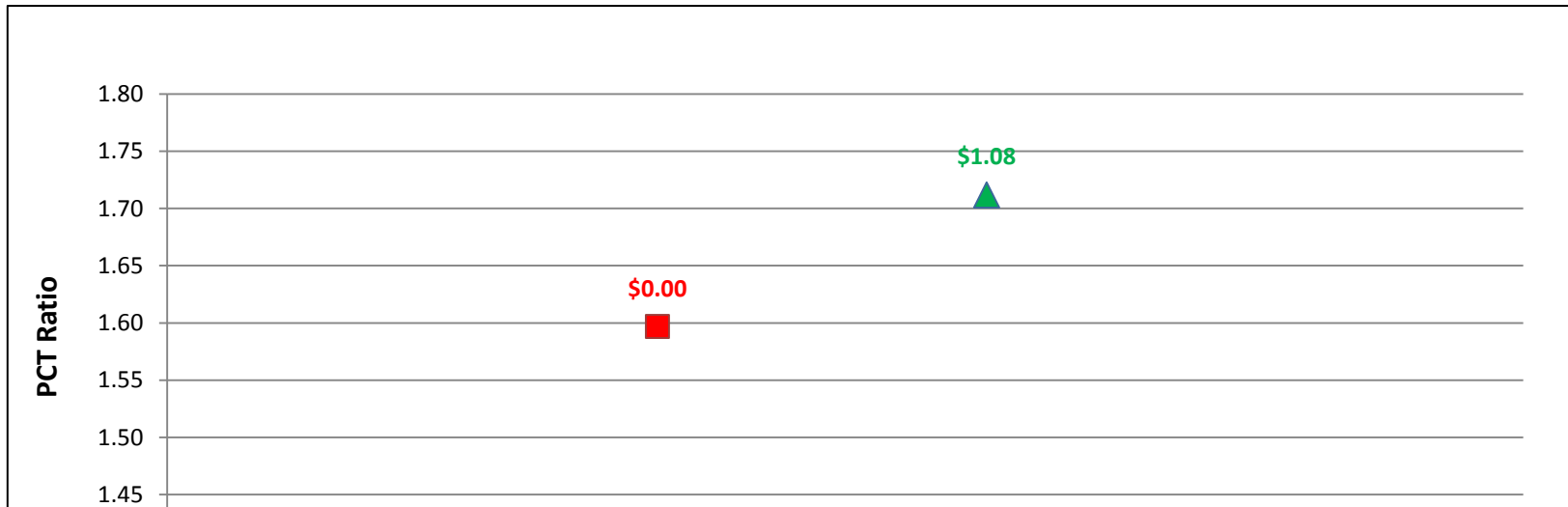


SGIP Cost Effectiveness Report
Participant Test Results (PCT)
MIRR Graphs

PRT - Commercial - PG&E

	Rebate (\$/watt)	MIRR	PCT-2014
▲ Actual Rebate - 2014	\$1.08	16.0%	1.71
■ No Rebate	\$0.00	14.8%	1.60
● Rebate to Reach MIRR of 5%	\$0.00	0.0%	0.00
● Rebate to Reach MIRR of 6%	\$0.00	0.0%	0.00
● Rebate to Reach MIRR of 7%	\$0.00	0.0%	0.00
● Rebate to Reach MIRR of 8%	\$0.00	0.0%	0.00
● Rebate to Reach MIRR of 9%	\$0.00	0.0%	0.00
● Rebate to Reach MIRR of 10%	\$0.00	0.0%	0.00
● Rebate to Reach MIRR of 11%	\$0.00	0.0%	0.00
● Rebate to Reach MIRR of 12%	\$0.00	0.0%	0.00
● Rebate to Reach MIRR of 13%	\$0.00	0.0%	0.00
● Rebate to Reach MIRR of 14%	\$0.00	0.0%	0.00
● Rebate to Reach MIRR of 15%	\$0.00	0.0%	0.00

System Cost per Watt: \$4.14

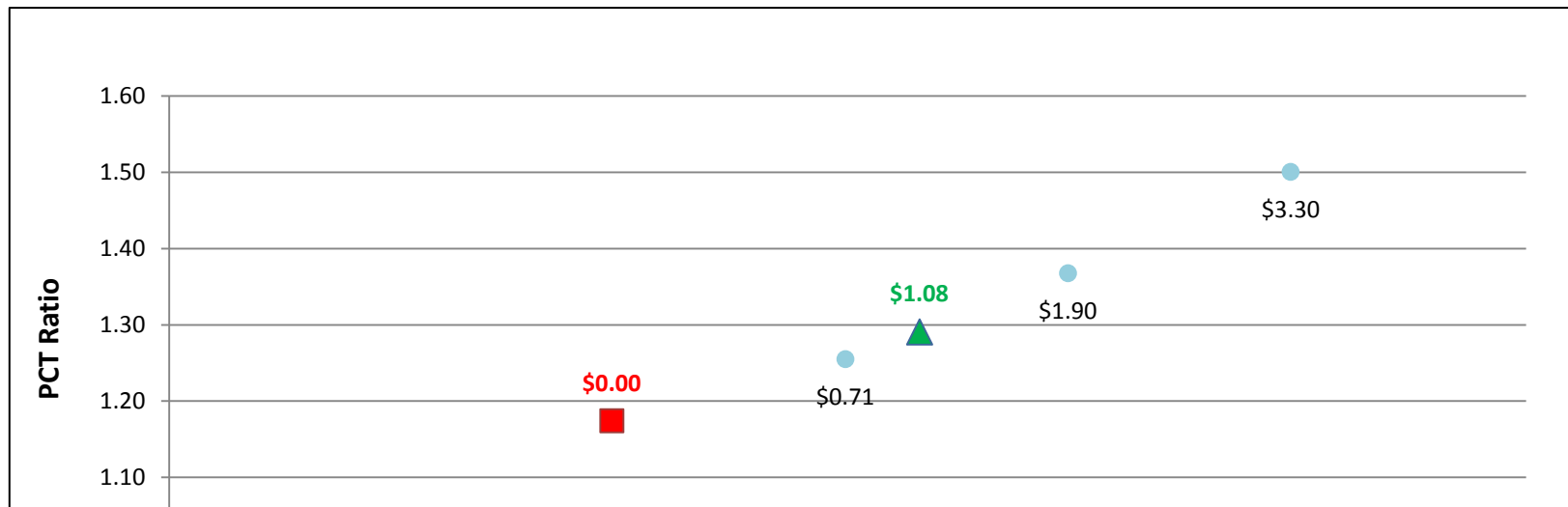


SGIP Cost Effectiveness Report
Participant Test Results (PCT)
MIRR Graphs

PRT - Commercial - SCE

	Rebate (\$/watt)	MIRR	PCT-2014
▲ Actual Rebate - 2014	\$1.08	13.3%	1.29
■ No Rebate	\$0.00	12.0%	1.17
● Rebate to Reach MIRR of 5%	\$0.00	0.0%	0.00
● Rebate to Reach MIRR of 6%	\$0.00	0.0%	0.00
● Rebate to Reach MIRR of 7%	\$0.00	0.0%	0.00
● Rebate to Reach MIRR of 8%	\$0.00	0.0%	0.00
● Rebate to Reach MIRR of 9%	\$0.00	0.0%	0.00
● Rebate to Reach MIRR of 10%	\$0.00	0.0%	0.00
● Rebate to Reach MIRR of 11%	\$0.00	0.0%	0.00
● Rebate to Reach MIRR of 12%	\$0.00	0.0%	0.00
● Rebate to Reach MIRR of 13%	\$0.71	13.0%	1.26
● Rebate to Reach MIRR of 14%	\$1.90	14.0%	1.37
● Rebate to Reach MIRR of 15%	\$3.30	15.0%	1.50

System Cost per Watt: \$4.14

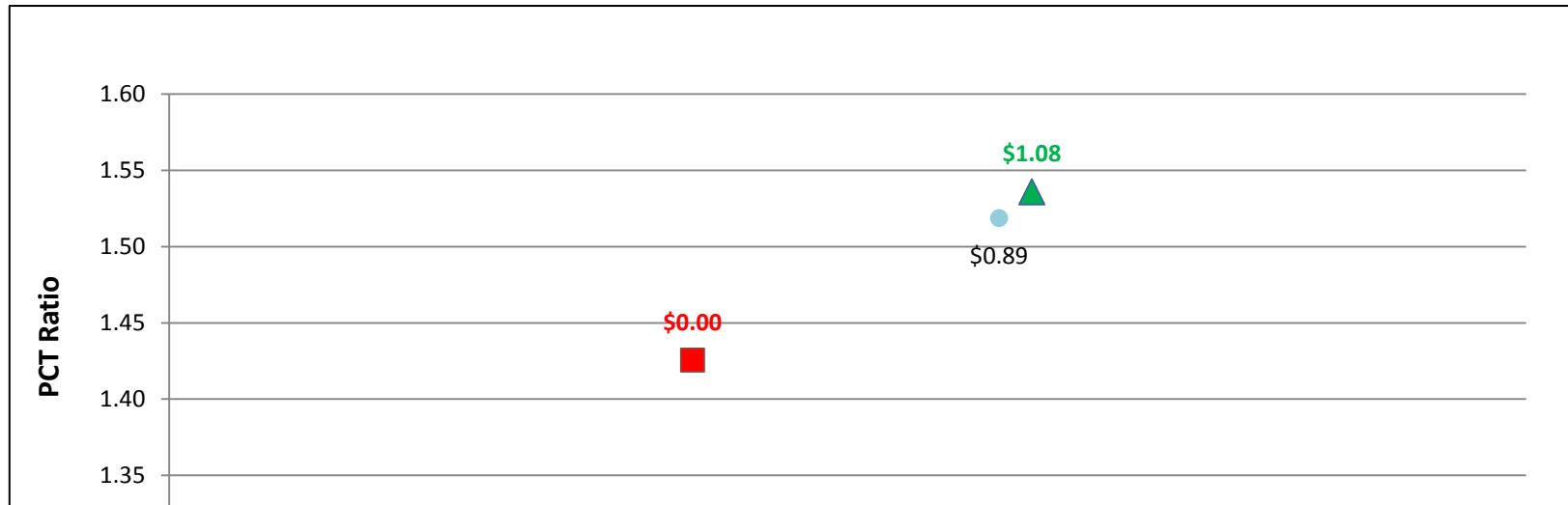


SGIP Cost Effectiveness Report
Participant Test Results (PCT)
MIRR Graphs

PRT - Commercial - SDG&E

	Rebate (\$/watt)	MIRR	PCT-2014
▲ Actual Rebate - 2014	\$1.08	15.2%	1.54
■ No Rebate	\$0.00	13.9%	1.43
● Rebate to Reach MIRR of 5%	\$0.00	0.0%	0.00
● Rebate to Reach MIRR of 6%	\$0.00	0.0%	0.00
● Rebate to Reach MIRR of 7%	\$0.00	0.0%	0.00
● Rebate to Reach MIRR of 8%	\$0.00	0.0%	0.00
● Rebate to Reach MIRR of 9%	\$0.00	0.0%	0.00
● Rebate to Reach MIRR of 10%	\$0.00	0.0%	0.00
● Rebate to Reach MIRR of 11%	\$0.00	0.0%	0.00
● Rebate to Reach MIRR of 12%	\$0.00	0.0%	0.00
● Rebate to Reach MIRR of 13%	\$0.00	0.0%	0.00
● Rebate to Reach MIRR of 14%	\$0.00	0.0%	0.00
● Rebate to Reach MIRR of 15%	\$0.89	15.1%	1.52

System Cost per Watt: \$4.14





Organic Rankine Cycle

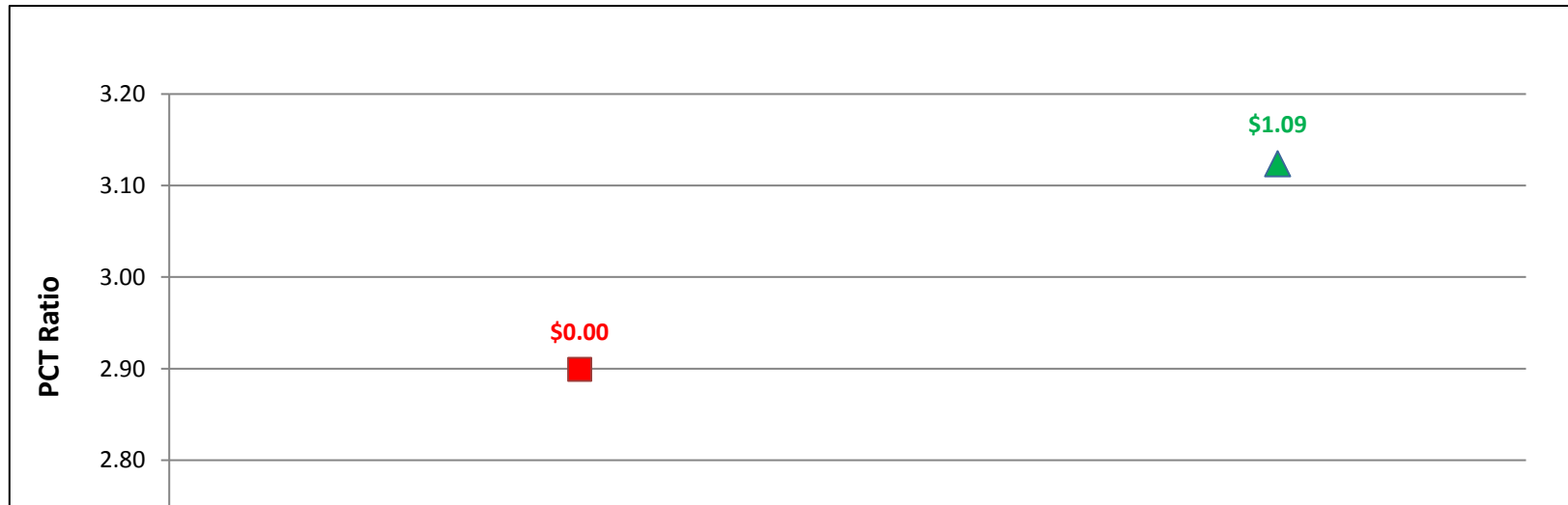


SGIP Cost Effectiveness Report
Participant Test Results (PCT)
MIRR Graphs

ORC500kW - Government/Non-Profit - PG&E

	Rebate (\$/watt)	MIRR	PCT-2014
▲ Actual Rebate - 2014	\$1.09	17.9%	3.12
■ No Rebate	\$0.00	14.8%	2.90
● Rebate to Reach MIRR of 5%	\$0.00	0.0%	0.00
● Rebate to Reach MIRR of 6%	\$0.00	0.0%	0.00
● Rebate to Reach MIRR of 7%	\$0.00	0.0%	0.00
● Rebate to Reach MIRR of 8%	\$0.00	0.0%	0.00
● Rebate to Reach MIRR of 9%	\$0.00	0.0%	0.00
● Rebate to Reach MIRR of 10%	\$0.00	0.0%	0.00
● Rebate to Reach MIRR of 11%	\$0.00	0.0%	0.00
● Rebate to Reach MIRR of 12%	\$0.00	0.0%	0.00
● Rebate to Reach MIRR of 13%	\$0.00	0.0%	0.00
● Rebate to Reach MIRR of 14%	\$0.00	0.0%	0.00
● Rebate to Reach MIRR of 15%	\$0.00	0.0%	0.00

System Cost per Watt: \$3.67

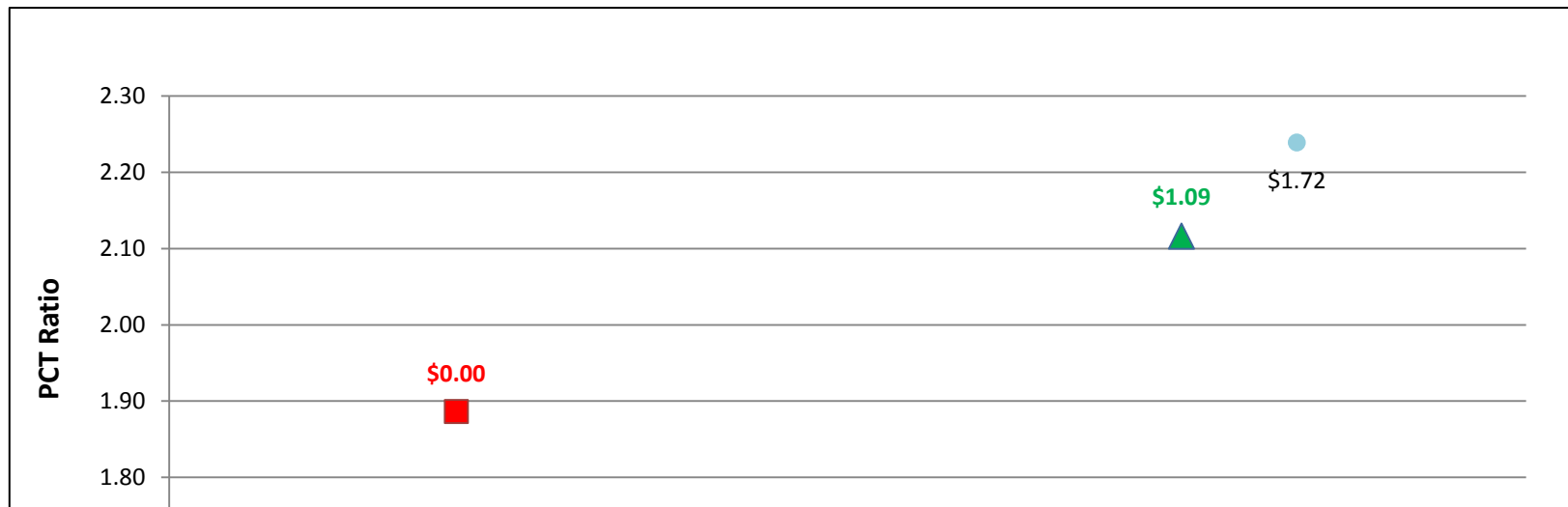


SGIP Cost Effectiveness Report
Participant Test Results (PCT)
MIRR Graphs

ORC500kW - Government/Non-Profit - SCE

	Rebate (\$/watt)	MIRR	PCT-2014
▲ Actual Rebate - 2014	\$1.09	14.5%	2.12
■ No Rebate	\$0.00	11.3%	1.89
● Rebate to Reach MIRR of 5%	\$0.00	0.0%	0.00
● Rebate to Reach MIRR of 6%	\$0.00	0.0%	0.00
● Rebate to Reach MIRR of 7%	\$0.00	0.0%	0.00
● Rebate to Reach MIRR of 8%	\$0.00	0.0%	0.00
● Rebate to Reach MIRR of 9%	\$0.00	0.0%	0.00
● Rebate to Reach MIRR of 10%	\$0.00	0.0%	0.00
● Rebate to Reach MIRR of 11%	\$0.00	0.0%	0.00
● Rebate to Reach MIRR of 12%	\$0.00	0.0%	0.00
● Rebate to Reach MIRR of 13%	\$0.00	0.0%	0.00
● Rebate to Reach MIRR of 14%	\$0.00	0.0%	0.00
● Rebate to Reach MIRR of 15%	\$1.72	15.0%	2.24

System Cost per Watt: \$3.67

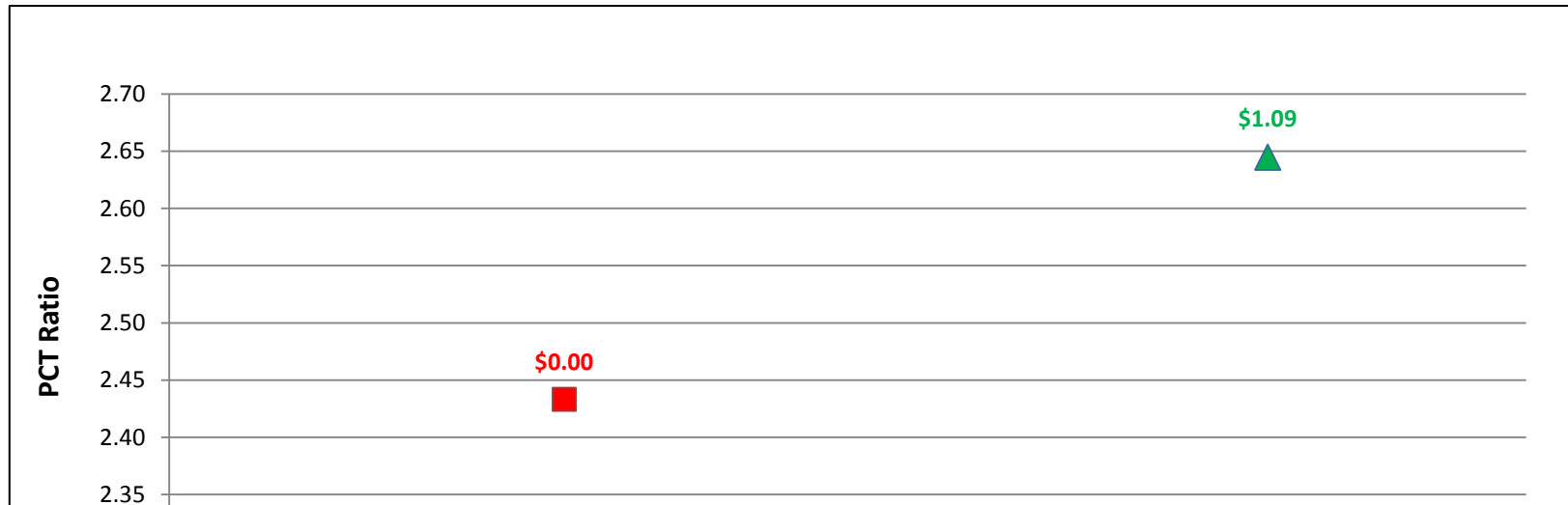


SGIP Cost Effectiveness Report
Participant Test Results (PCT)
MIRR Graphs

ORC500kW - Government/Non-Profit - SDG&E

	Rebate (\$/watt)	MIRR	PCT-2014
▲ Actual Rebate - 2014	\$1.09	16.9%	2.64
■ No Rebate	\$0.00	13.7%	2.43
● Rebate to Reach MIRR of 5%	\$0.00	0.0%	0.00
● Rebate to Reach MIRR of 6%	\$0.00	0.0%	0.00
● Rebate to Reach MIRR of 7%	\$0.00	0.0%	0.00
● Rebate to Reach MIRR of 8%	\$0.00	0.0%	0.00
● Rebate to Reach MIRR of 9%	\$0.00	0.0%	0.00
● Rebate to Reach MIRR of 10%	\$0.00	0.0%	0.00
● Rebate to Reach MIRR of 11%	\$0.00	0.0%	0.00
● Rebate to Reach MIRR of 12%	\$0.00	0.0%	0.00
● Rebate to Reach MIRR of 13%	\$0.00	0.0%	0.00
● Rebate to Reach MIRR of 14%	\$0.00	0.0%	0.00
● Rebate to Reach MIRR of 15%	\$0.00	0.0%	0.00

System Cost per Watt: \$3.67



SGIP Cost Effectiveness Report
Participant Test Results (PCT)
MIRR Graphs

ORC500kW - Commercial - PG&E

	Rebate (\$/watt)	MIRR	PCT-2014
▲ Actual Rebate - 2014	\$1.09	16.8%	1.95
■ No Rebate	\$0.00	15.4%	1.80
● Rebate to Reach MIRR of 5%	\$0.00	0.0%	0.00
● Rebate to Reach MIRR of 6%	\$0.00	0.0%	0.00
● Rebate to Reach MIRR of 7%	\$0.00	0.0%	0.00
● Rebate to Reach MIRR of 8%	\$0.00	0.0%	0.00
● Rebate to Reach MIRR of 9%	\$0.00	0.0%	0.00
● Rebate to Reach MIRR of 10%	\$0.00	0.0%	0.00
● Rebate to Reach MIRR of 11%	\$0.00	0.0%	0.00
● Rebate to Reach MIRR of 12%	\$0.00	0.0%	0.00
● Rebate to Reach MIRR of 13%	\$0.00	0.0%	0.00
● Rebate to Reach MIRR of 14%	\$0.00	0.0%	0.00
● Rebate to Reach MIRR of 15%	\$0.00	0.0%	0.00

System Cost per Watt: \$3.67

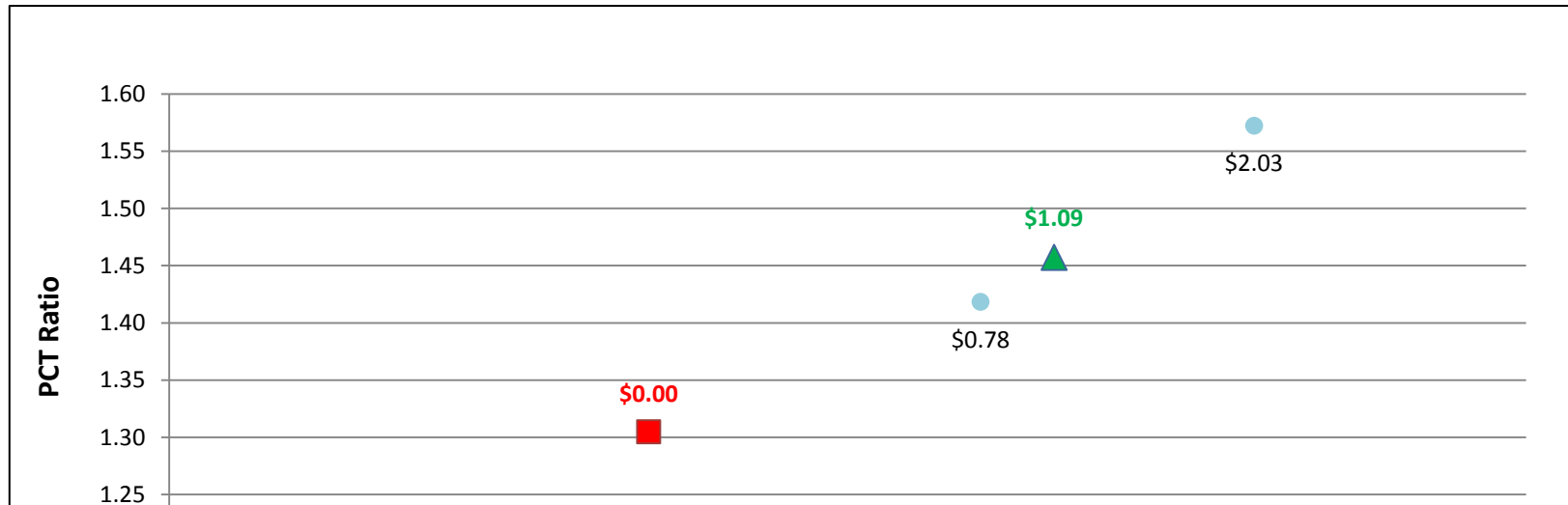


SGIP Cost Effectiveness Report
Participant Test Results (PCT)
MIRR Graphs

ORC500kW - Commercial - SCE

	Rebate (\$/watt)	MIRR	PCT-2014
▲ Actual Rebate - 2014	\$1.09	14.3%	1.46
■ No Rebate	\$0.00	12.8%	1.30
● Rebate to Reach MIRR of 5%	\$0.00	0.0%	0.00
● Rebate to Reach MIRR of 6%	\$0.00	0.0%	0.00
● Rebate to Reach MIRR of 7%	\$0.00	0.0%	0.00
● Rebate to Reach MIRR of 8%	\$0.00	0.0%	0.00
● Rebate to Reach MIRR of 9%	\$0.00	0.0%	0.00
● Rebate to Reach MIRR of 10%	\$0.00	0.0%	0.00
● Rebate to Reach MIRR of 11%	\$0.00	0.0%	0.00
● Rebate to Reach MIRR of 12%	\$0.00	0.0%	0.00
● Rebate to Reach MIRR of 13%	\$0.00	0.0%	0.00
● Rebate to Reach MIRR of 14%	\$0.78	14.0%	1.42
● Rebate to Reach MIRR of 15%	\$2.03	15.0%	1.57

System Cost per Watt: \$3.67

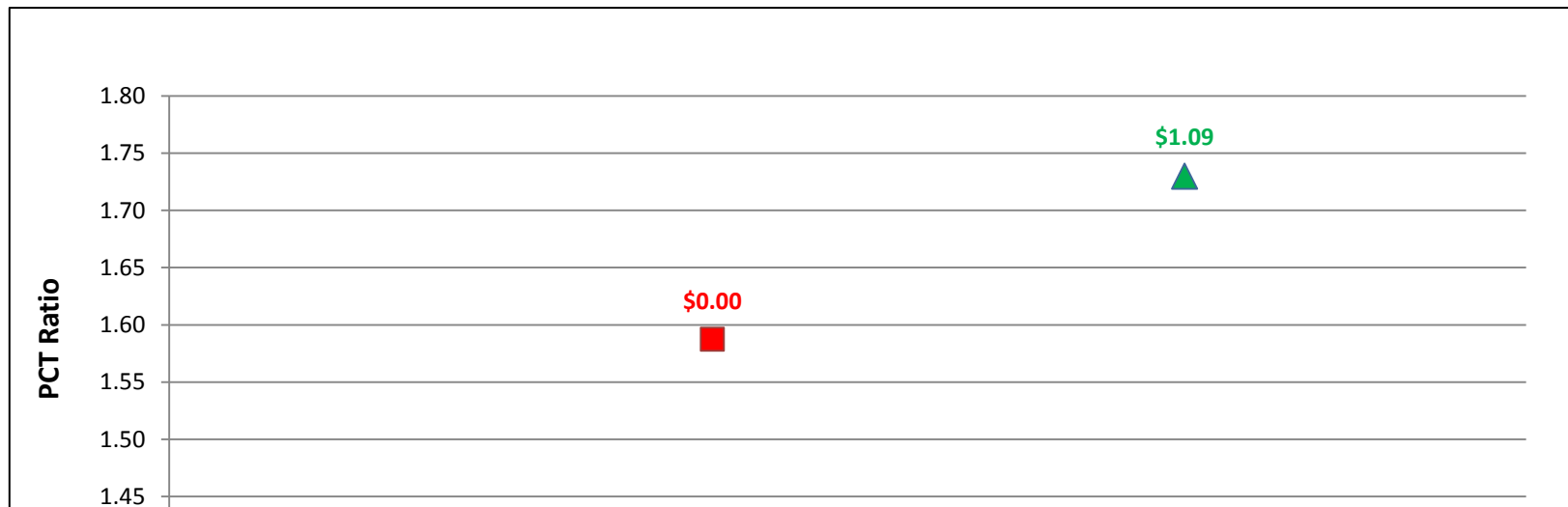


SGIP Cost Effectiveness Report
Participant Test Results (PCT)
MIRR Graphs

ORC500kW - Commercial - SDG&E

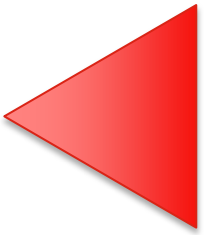
	Rebate (\$/watt)	MIRR	PCT-2014
▲ Actual Rebate - 2014	\$1.09	16.0%	1.73
■ No Rebate	\$0.00	14.6%	1.59
● Rebate to Reach MIRR of 5%	\$0.00	0.0%	0.00
● Rebate to Reach MIRR of 6%	\$0.00	0.0%	0.00
● Rebate to Reach MIRR of 7%	\$0.00	0.0%	0.00
● Rebate to Reach MIRR of 8%	\$0.00	0.0%	0.00
● Rebate to Reach MIRR of 9%	\$0.00	0.0%	0.00
● Rebate to Reach MIRR of 10%	\$0.00	0.0%	0.00
● Rebate to Reach MIRR of 11%	\$0.00	0.0%	0.00
● Rebate to Reach MIRR of 12%	\$0.00	0.0%	0.00
● Rebate to Reach MIRR of 13%	\$0.00	0.0%	0.00
● Rebate to Reach MIRR of 14%	\$0.00	0.0%	0.00
● Rebate to Reach MIRR of 15%	\$0.00	0.0%	0.00

System Cost per Watt: \$3.67





Gas Turbines



SGIP Cost Effectiveness Report
Participant Test Results (PCT)
MIRR Graphs

GTg3to7MW w/ Directed BioGas - Government/Non-Profit - PG&E

	Rebate (\$/watt)	MIRR	PCT-2014
▲ Actual Rebate - 2014	\$0.50	-100.0%	0.72
■ No Rebate	\$0.00	-100.0%	0.70
● Rebate to Reach MIRR of 5%	\$0.00	0.0%	0.00
● Rebate to Reach MIRR of 6%	\$0.00	0.0%	0.00
● Rebate to Reach MIRR of 7%	\$0.00	0.0%	0.00
● Rebate to Reach MIRR of 8%	\$0.00	0.0%	0.00
● Rebate to Reach MIRR of 9%	\$0.00	0.0%	0.00
● Rebate to Reach MIRR of 10%	\$0.00	0.0%	0.00
● Rebate to Reach MIRR of 11%	\$0.00	0.0%	0.00
● Rebate to Reach MIRR of 12%	\$0.00	0.0%	0.00
● Rebate to Reach MIRR of 13%	\$0.00	0.0%	0.00
● Rebate to Reach MIRR of 14%	\$0.00	0.0%	0.00
● Rebate to Reach MIRR of 15%	\$0.00	0.0%	0.00

System Cost per Watt: \$2.82



SGIP Cost Effectiveness Report
Participant Test Results (PCT)
MIRR Graphs

GTg3to7MW w/ Directed BioGas - Government/Non-Profit - SCE

	Rebate (\$/watt)	MIRR	PCT-2014
▲ Actual Rebate - 2014	\$0.50	-100.0%	0.56
■ No Rebate	\$0.00	-100.0%	0.54
● Rebate to Reach MIRR of 5%	\$0.00	0.0%	0.00
● Rebate to Reach MIRR of 6%	\$0.00	0.0%	0.00
● Rebate to Reach MIRR of 7%	\$0.00	0.0%	0.00
● Rebate to Reach MIRR of 8%	\$0.00	0.0%	0.00
● Rebate to Reach MIRR of 9%	\$0.00	0.0%	0.00
● Rebate to Reach MIRR of 10%	\$0.00	0.0%	0.00
● Rebate to Reach MIRR of 11%	\$0.00	0.0%	0.00
● Rebate to Reach MIRR of 12%	\$0.00	0.0%	0.00
● Rebate to Reach MIRR of 13%	\$0.00	0.0%	0.00
● Rebate to Reach MIRR of 14%	\$0.00	0.0%	0.00
● Rebate to Reach MIRR of 15%	\$0.00	0.0%	0.00

System Cost per Watt: \$2.82

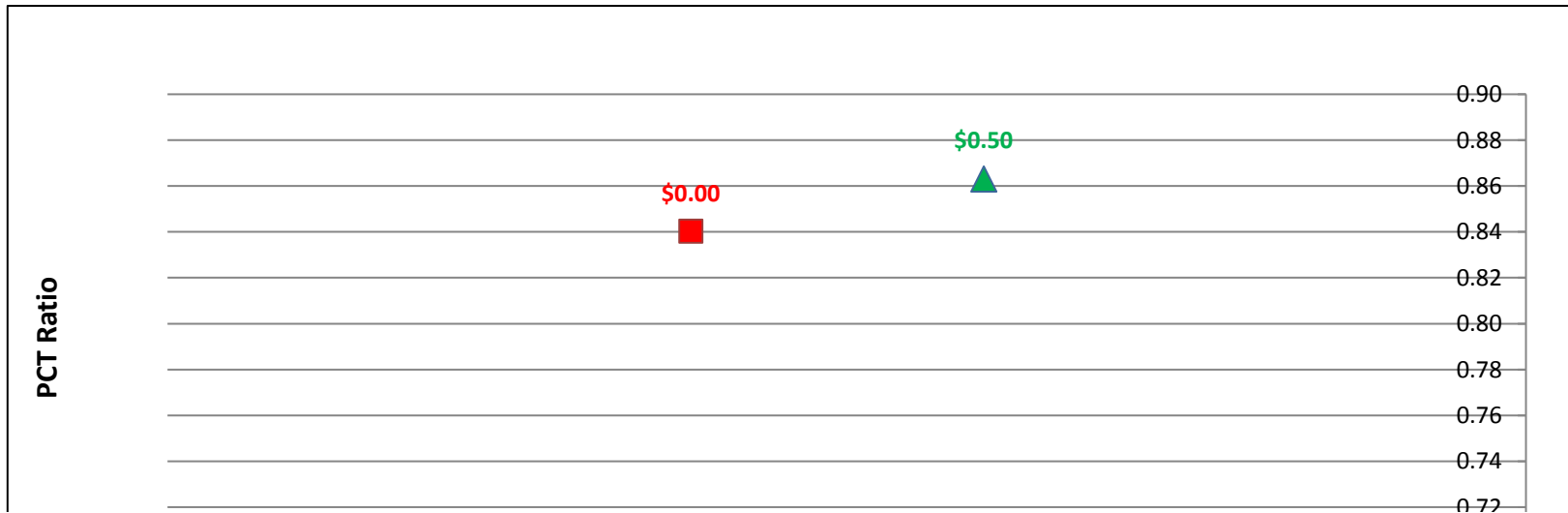


SGIP Cost Effectiveness Report
Participant Test Results (PCT)
MIRR Graphs

GTg3to7MW w/ Directed BioGas - Government/Non-Profit - SDG&E

	Rebate (\$/watt)	MIRR	PCT-2014
▲ Actual Rebate - 2014	\$0.50	-14.2%	0.86
■ No Rebate	\$0.00	-14.8%	0.84
● Rebate to Reach MIRR of 5%	\$0.00	0.0%	0.00
● Rebate to Reach MIRR of 6%	\$0.00	0.0%	0.00
● Rebate to Reach MIRR of 7%	\$0.00	0.0%	0.00
● Rebate to Reach MIRR of 8%	\$0.00	0.0%	0.00
● Rebate to Reach MIRR of 9%	\$0.00	0.0%	0.00
● Rebate to Reach MIRR of 10%	\$0.00	0.0%	0.00
● Rebate to Reach MIRR of 11%	\$0.00	0.0%	0.00
● Rebate to Reach MIRR of 12%	\$0.00	0.0%	0.00
● Rebate to Reach MIRR of 13%	\$0.00	0.0%	0.00
● Rebate to Reach MIRR of 14%	\$0.00	0.0%	0.00
● Rebate to Reach MIRR of 15%	\$0.00	0.0%	0.00

System Cost per Watt: \$2.82



SGIP Cost Effectiveness Report
Participant Test Results (PCT)
MIRR Graphs

GTg3to7MW w/ Natural Gas - Government/Non-Profit - PG&E

	Rebate (\$/watt)	MIRR	PCT-2014
▲ Actual Rebate - 2014	\$0.11	8.1%	1.07
■ No Rebate	\$0.00	7.7%	1.07
● Rebate to Reach MIRR of 5%	\$0.00	0.0%	0.00
● Rebate to Reach MIRR of 6%	\$0.00	0.0%	0.00
● Rebate to Reach MIRR of 7%	\$0.00	0.0%	0.00
● Rebate to Reach MIRR of 8%	\$0.00	0.0%	0.00
● Rebate to Reach MIRR of 9%	\$0.53	9.0%	1.09
● Rebate to Reach MIRR of 10%	\$1.14	10.0%	1.13
● Rebate to Reach MIRR of 11%	\$1.87	11.0%	1.17
● Rebate to Reach MIRR of 12%	\$2.65	11.9%	1.21
● Rebate to Reach MIRR of 13%	\$0.00	0.0%	0.00
● Rebate to Reach MIRR of 14%	\$0.00	0.0%	0.00
● Rebate to Reach MIRR of 15%	\$0.00	0.0%	0.00

System Cost per Watt: \$2.82

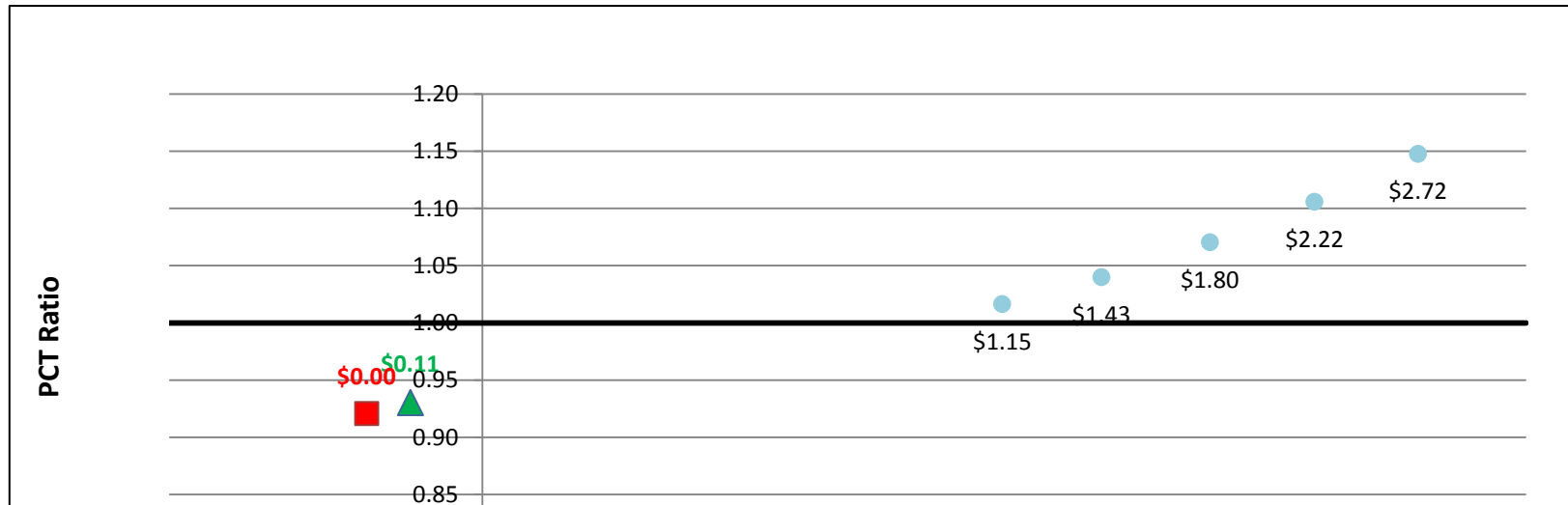


SGIP Cost Effectiveness Report
Participant Test Results (PCT)
MIRR Graphs

GTg3to7MW w/ Natural Gas - Government/Non-Profit - SCE

	Rebate (\$/watt)	MIRR	PCT-2014
▲ Actual Rebate - 2014	\$0.11	-0.7%	0.93
■ No Rebate	\$0.00	-1.1%	0.92
● Rebate to Reach MIRR of 5%	\$1.15	5.0%	1.02
● Rebate to Reach MIRR of 6%	\$1.43	5.9%	1.04
● Rebate to Reach MIRR of 7%	\$1.80	7.0%	1.07
● Rebate to Reach MIRR of 8%	\$2.22	8.0%	1.11
● Rebate to Reach MIRR of 9%	\$2.72	9.0%	1.15
● Rebate to Reach MIRR of 10%	\$0.00	0.0%	0.00
● Rebate to Reach MIRR of 11%	\$0.00	0.0%	0.00
● Rebate to Reach MIRR of 12%	\$0.00	0.0%	0.00
● Rebate to Reach MIRR of 13%	\$0.00	0.0%	0.00
● Rebate to Reach MIRR of 14%	\$0.00	0.0%	0.00
● Rebate to Reach MIRR of 15%	\$0.00	0.0%	0.00

System Cost per Watt: \$2.82

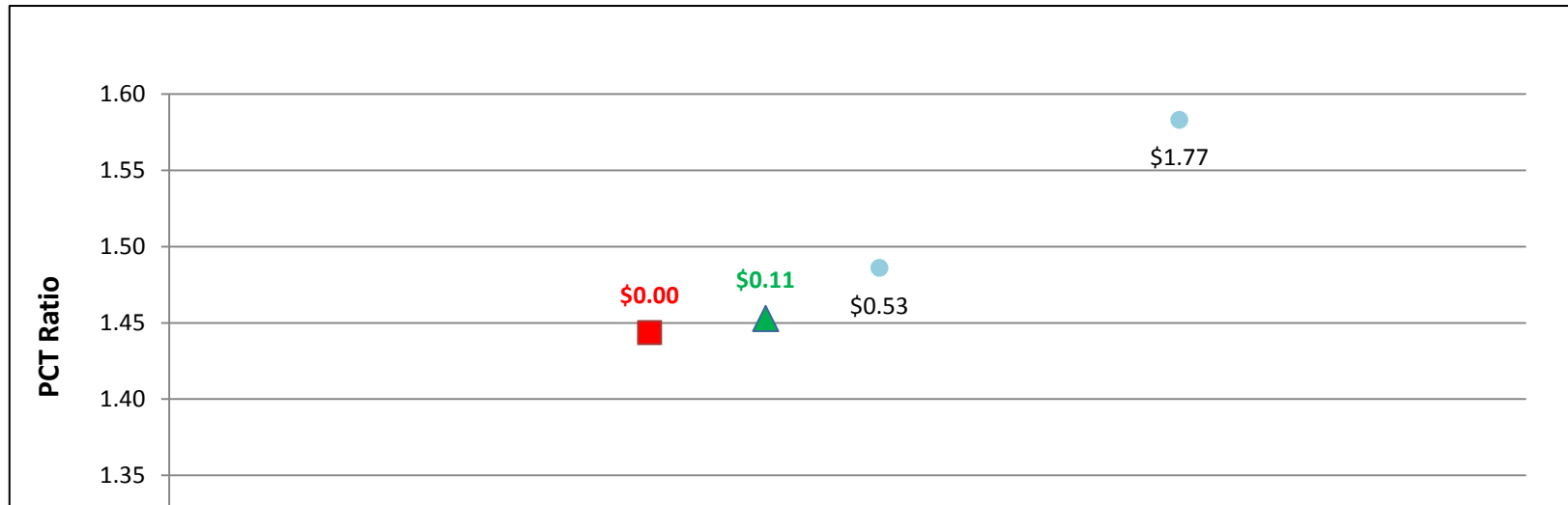


SGIP Cost Effectiveness Report
Participant Test Results (PCT)
MIRR Graphs

GTg3to7MW w/ Natural Gas - Government/Non-Profit - SDG&E

	Rebate (\$/watt)	MIRR	PCT-2014
▲ Actual Rebate - 2014	\$0.11	13.8%	1.45
■ No Rebate	\$0.00	13.4%	1.44
● Rebate to Reach MIRR of 5%	\$0.00	0.0%	0.00
● Rebate to Reach MIRR of 6%	\$0.00	0.0%	0.00
● Rebate to Reach MIRR of 7%	\$0.00	0.0%	0.00
● Rebate to Reach MIRR of 8%	\$0.00	0.0%	0.00
● Rebate to Reach MIRR of 9%	\$0.00	0.0%	0.00
● Rebate to Reach MIRR of 10%	\$0.00	0.0%	0.00
● Rebate to Reach MIRR of 11%	\$0.00	0.0%	0.00
● Rebate to Reach MIRR of 12%	\$0.00	0.0%	0.00
● Rebate to Reach MIRR of 13%	\$0.00	0.0%	0.00
● Rebate to Reach MIRR of 14%	\$0.53	14.1%	1.49
● Rebate to Reach MIRR of 15%	\$1.77	15.0%	1.58

System Cost per Watt: \$2.82

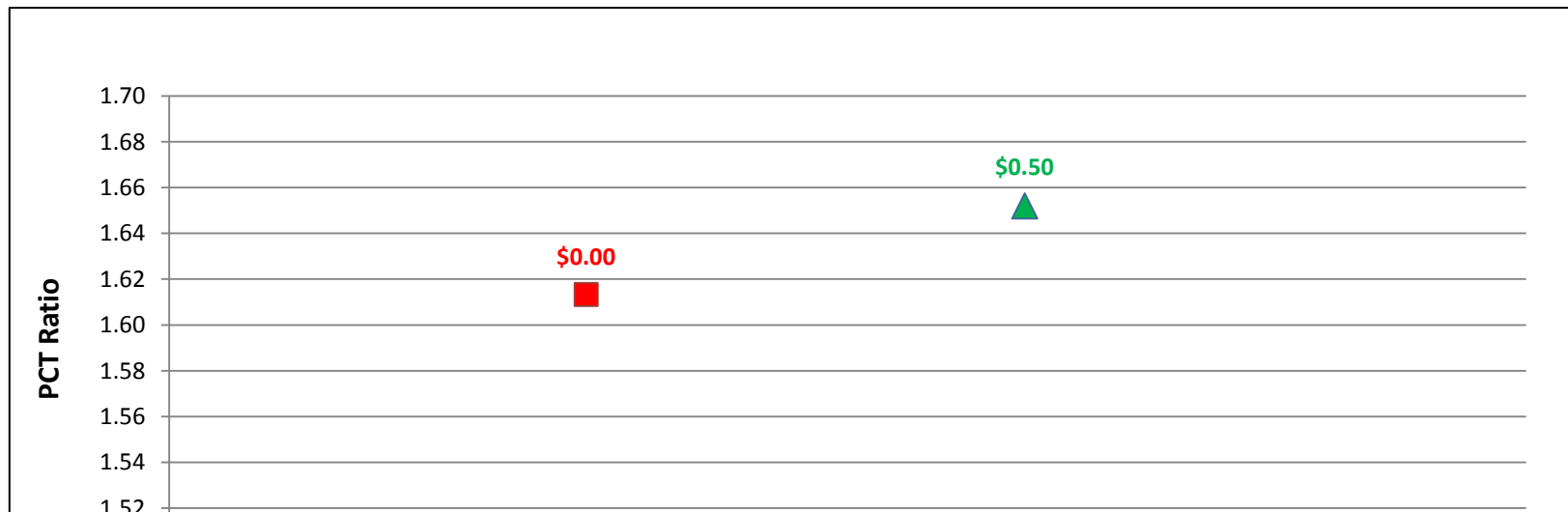


SGIP Cost Effectiveness Report
Participant Test Results (PCT)
MIRR Graphs

GTg3to7MW w/ On-Site BioGas - Government/Non-Profit - PG&E

	Rebate (\$/watt)	MIRR	PCT-2014
▲ Actual Rebate - 2014	\$0.50	15.5%	1.65
■ No Rebate	\$0.00	14.2%	1.61
● Rebate to Reach MIRR of 5%	\$0.00	0.0%	0.00
● Rebate to Reach MIRR of 6%	\$0.00	0.0%	0.00
● Rebate to Reach MIRR of 7%	\$0.00	0.0%	0.00
● Rebate to Reach MIRR of 8%	\$0.00	0.0%	0.00
● Rebate to Reach MIRR of 9%	\$0.00	0.0%	0.00
● Rebate to Reach MIRR of 10%	\$0.00	0.0%	0.00
● Rebate to Reach MIRR of 11%	\$0.00	0.0%	0.00
● Rebate to Reach MIRR of 12%	\$0.00	0.0%	0.00
● Rebate to Reach MIRR of 13%	\$0.00	0.0%	0.00
● Rebate to Reach MIRR of 14%	\$0.00	0.0%	0.00
● Rebate to Reach MIRR of 15%	\$0.00	0.0%	0.00

System Cost per Watt: \$3.57

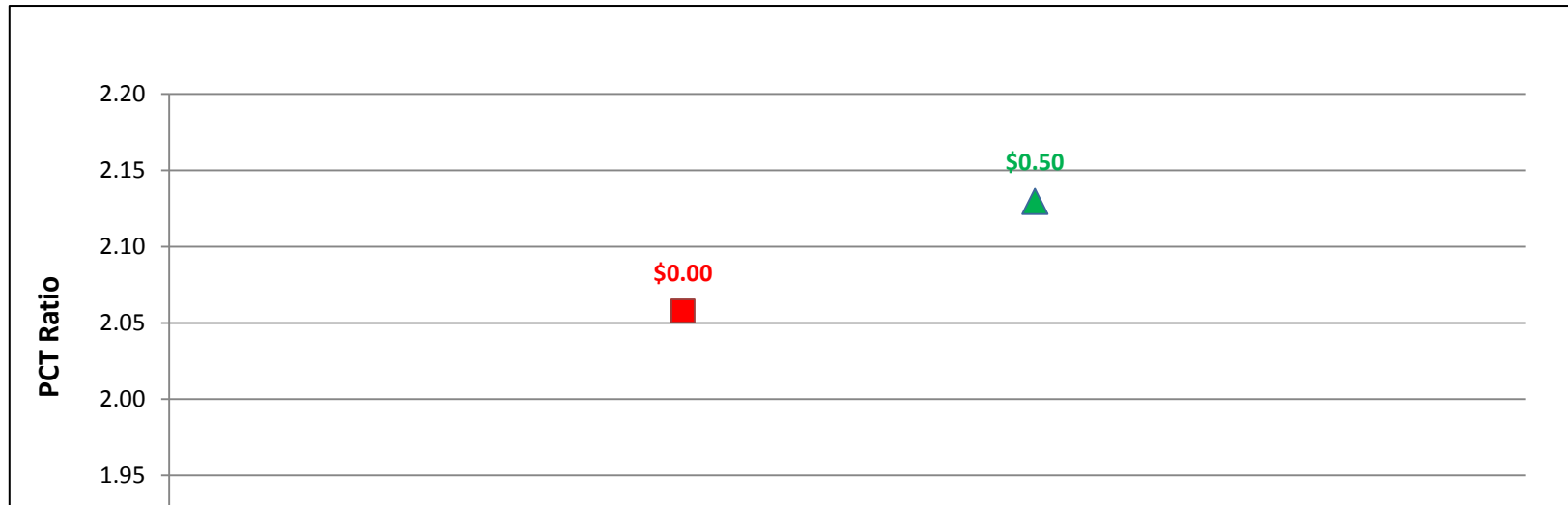


SGIP Cost Effectiveness Report
Participant Test Results (PCT)
MIRR Graphs

GTg3to7MW w/ On-Site BioGas - Government/Non-Profit - SCE

	Rebate (\$/watt)	MIRR	PCT-2014
▲ Actual Rebate - 2014	\$0.50	15.2%	2.13
■ No Rebate	\$0.00	13.9%	2.06
● Rebate to Reach MIRR of 5%	\$0.00	0.0%	0.00
● Rebate to Reach MIRR of 6%	\$0.00	0.0%	0.00
● Rebate to Reach MIRR of 7%	\$0.00	0.0%	0.00
● Rebate to Reach MIRR of 8%	\$0.00	0.0%	0.00
● Rebate to Reach MIRR of 9%	\$0.00	0.0%	0.00
● Rebate to Reach MIRR of 10%	\$0.00	0.0%	0.00
● Rebate to Reach MIRR of 11%	\$0.00	0.0%	0.00
● Rebate to Reach MIRR of 12%	\$0.00	0.0%	0.00
● Rebate to Reach MIRR of 13%	\$0.00	0.0%	0.00
● Rebate to Reach MIRR of 14%	\$0.00	0.0%	0.00
● Rebate to Reach MIRR of 15%	\$0.00	0.0%	0.00

System Cost per Watt: \$3.57

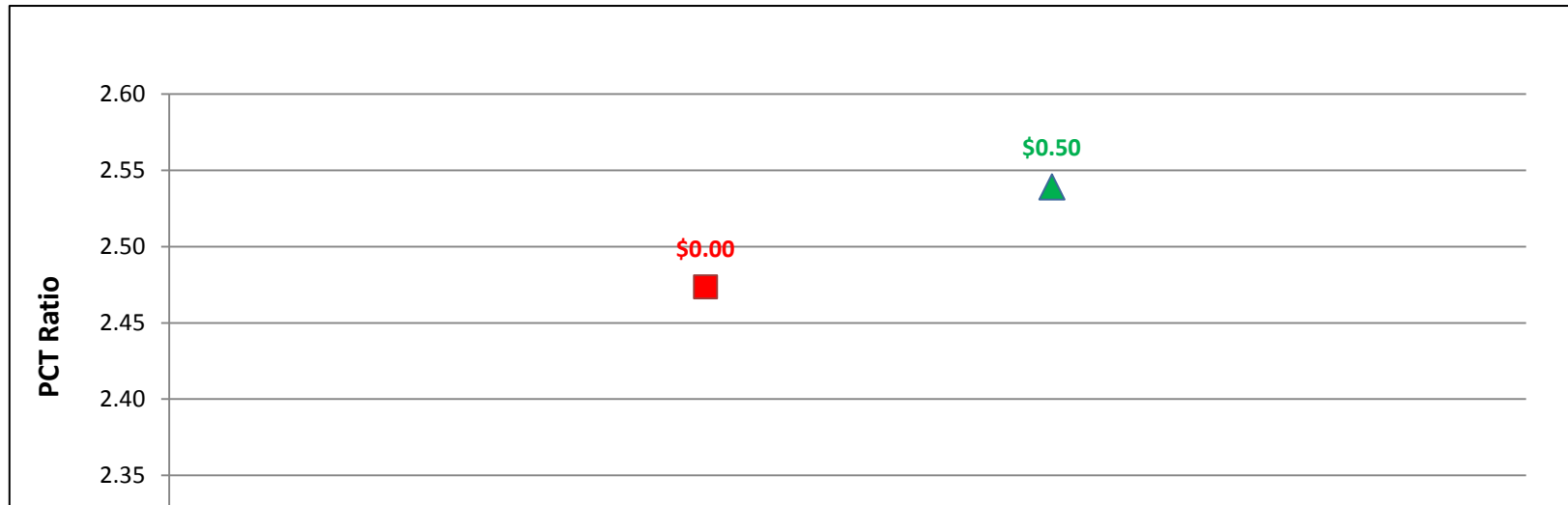


SGIP Cost Effectiveness Report
Participant Test Results (PCT)
MIRR Graphs

GTg3to7MW w/ On-Site BioGas - Government/Non-Profit - SDG&E

	Rebate (\$/watt)	MIRR	PCT-2014
▲ Actual Rebate - 2014	\$0.50	17.3%	2.54
■ No Rebate	\$0.00	16.0%	2.47
● Rebate to Reach MIRR of 5%	\$0.00	0.0%	0.00
● Rebate to Reach MIRR of 6%	\$0.00	0.0%	0.00
● Rebate to Reach MIRR of 7%	\$0.00	0.0%	0.00
● Rebate to Reach MIRR of 8%	\$0.00	0.0%	0.00
● Rebate to Reach MIRR of 9%	\$0.00	0.0%	0.00
● Rebate to Reach MIRR of 10%	\$0.00	0.0%	0.00
● Rebate to Reach MIRR of 11%	\$0.00	0.0%	0.00
● Rebate to Reach MIRR of 12%	\$0.00	0.0%	0.00
● Rebate to Reach MIRR of 13%	\$0.00	0.0%	0.00
● Rebate to Reach MIRR of 14%	\$0.00	0.0%	0.00
● Rebate to Reach MIRR of 15%	\$0.00	0.0%	0.00

System Cost per Watt: \$3.57



SGIP Cost Effectiveness Report
Participant Test Results (PCT)
MIRR Graphs

GTg3to7MW w/ Directed BioGas - Commercial - PG&E

	Rebate (\$/watt)	MIRR	PCT-2014
▲ Actual Rebate - 2014	\$0.50	-2.2%	0.83
■ No Rebate	\$0.00	-3.5%	0.82
● Rebate to Reach MIRR of 5%	\$2.56	5.0%	0.89
● Rebate to Reach MIRR of 6%	\$0.00	0.0%	0.00
● Rebate to Reach MIRR of 7%	\$0.00	0.0%	0.00
● Rebate to Reach MIRR of 8%	\$0.00	0.0%	0.00
● Rebate to Reach MIRR of 9%	\$0.00	0.0%	0.00
● Rebate to Reach MIRR of 10%	\$0.00	0.0%	0.00
● Rebate to Reach MIRR of 11%	\$0.00	0.0%	0.00
● Rebate to Reach MIRR of 12%	\$0.00	0.0%	0.00
● Rebate to Reach MIRR of 13%	\$0.00	0.0%	0.00
● Rebate to Reach MIRR of 14%	\$0.00	0.0%	0.00
● Rebate to Reach MIRR of 15%	\$0.00	0.0%	0.00

System Cost per Watt: \$2.82

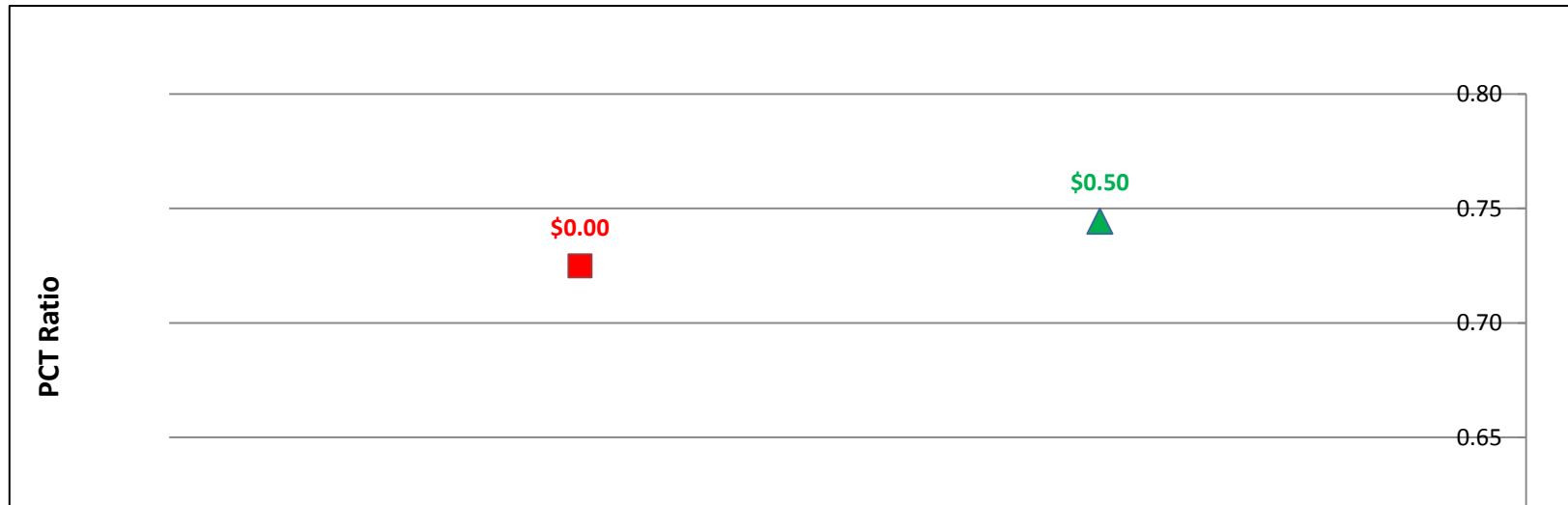


SGIP Cost Effectiveness Report
Participant Test Results (PCT)
MIRR Graphs

GTg3to7MW w/ Directed BioGas - Commercial - SCE

	Rebate (\$/watt)	MIRR	PCT-2014
▲ Actual Rebate - 2014	\$0.50	-6.3%	0.74
■ No Rebate	\$0.00	-7.8%	0.72
● Rebate to Reach MIRR of 5%	\$0.00	0.0%	0.00
● Rebate to Reach MIRR of 6%	\$0.00	0.0%	0.00
● Rebate to Reach MIRR of 7%	\$0.00	0.0%	0.00
● Rebate to Reach MIRR of 8%	\$0.00	0.0%	0.00
● Rebate to Reach MIRR of 9%	\$0.00	0.0%	0.00
● Rebate to Reach MIRR of 10%	\$0.00	0.0%	0.00
● Rebate to Reach MIRR of 11%	\$0.00	0.0%	0.00
● Rebate to Reach MIRR of 12%	\$0.00	0.0%	0.00
● Rebate to Reach MIRR of 13%	\$0.00	0.0%	0.00
● Rebate to Reach MIRR of 14%	\$0.00	0.0%	0.00
● Rebate to Reach MIRR of 15%	\$0.00	0.0%	0.00

System Cost per Watt: \$2.82

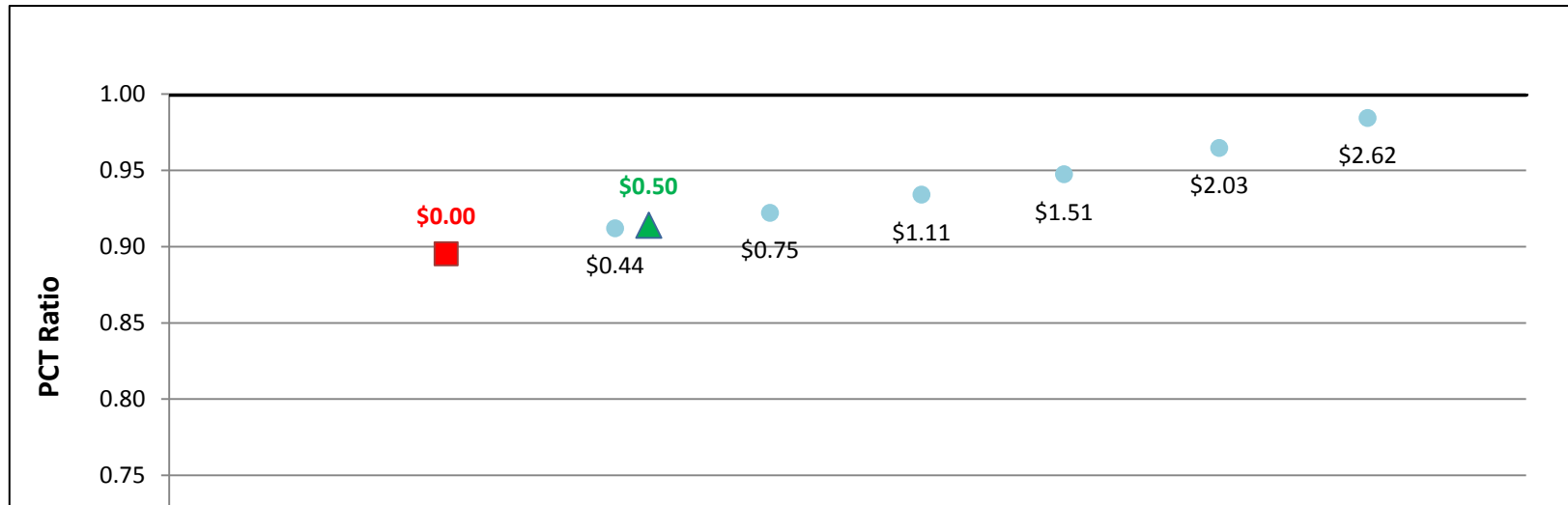


SGIP Cost Effectiveness Report
Participant Test Results (PCT)
MIRR Graphs

GTg3to7MW w/ Directed BioGas - Commercial - SDG&E

	Rebate (\$/watt)	MIRR	PCT-2014
▲ Actual Rebate - 2014	\$0.50	5.2%	0.91
■ No Rebate	\$0.00	3.8%	0.90
● Rebate to Reach MIRR of 5%	\$0.44	5.0%	0.91
● Rebate to Reach MIRR of 6%	\$0.75	6.0%	0.92
● Rebate to Reach MIRR of 7%	\$1.11	7.0%	0.93
● Rebate to Reach MIRR of 8%	\$1.51	7.9%	0.95
● Rebate to Reach MIRR of 9%	\$2.03	9.0%	0.96
● Rebate to Reach MIRR of 10%	\$2.62	9.9%	0.98
● Rebate to Reach MIRR of 11%	\$0.00	0.0%	0.00
● Rebate to Reach MIRR of 12%	\$0.00	0.0%	0.00
● Rebate to Reach MIRR of 13%	\$0.00	0.0%	0.00
● Rebate to Reach MIRR of 14%	\$0.00	0.0%	0.00
● Rebate to Reach MIRR of 15%	\$0.00	0.0%	0.00

System Cost per Watt: \$2.82



SGIP Cost Effectiveness Report
Participant Test Results (PCT)
MIRR Graphs

GTg3to7MW w/ Natural Gas - Commercial - PG&E

	Rebate (\$/watt)	MIRR	PCT-2014
▲ Actual Rebate - 2014	\$0.11	9.5%	0.98
■ No Rebate	\$0.00	9.2%	0.97
● Rebate to Reach MIRR of 5%	\$0.00	0.0%	0.00
● Rebate to Reach MIRR of 6%	\$0.00	0.0%	0.00
● Rebate to Reach MIRR of 7%	\$0.00	0.0%	0.00
● Rebate to Reach MIRR of 8%	\$0.00	0.0%	0.00
● Rebate to Reach MIRR of 9%	\$0.00	0.0%	0.00
● Rebate to Reach MIRR of 10%	\$0.37	10.0%	0.99
● Rebate to Reach MIRR of 11%	\$0.95	11.0%	1.01
● Rebate to Reach MIRR of 12%	\$1.64	12.0%	1.04
● Rebate to Reach MIRR of 13%	\$2.41	13.0%	1.07
● Rebate to Reach MIRR of 14%	\$0.00	0.0%	0.00
● Rebate to Reach MIRR of 15%	\$0.00	0.0%	0.00

System Cost per Watt: \$2.82

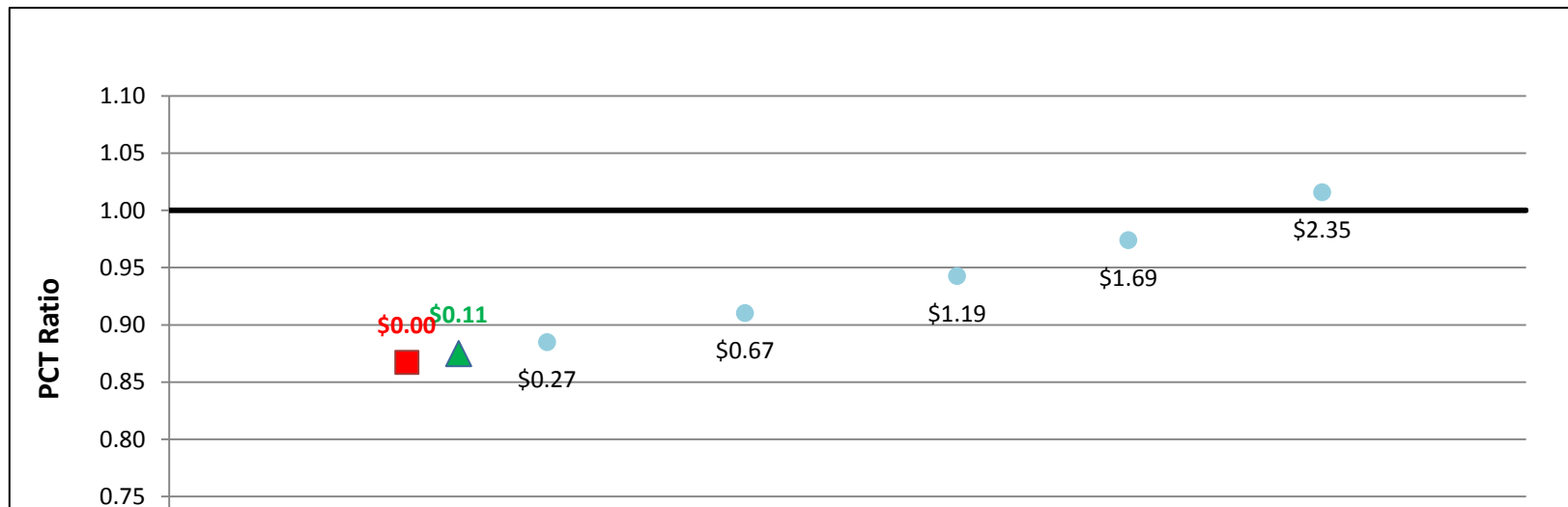


SGIP Cost Effectiveness Report
Participant Test Results (PCT)
MIRR Graphs

GTg3to7MW w/ Natural Gas - Commercial - SCE

	Rebate (\$/watt)	MIRR	PCT-2014
▲ Actual Rebate - 2014	\$0.11	6.5%	0.87
■ No Rebate	\$0.00	6.2%	0.87
● Rebate to Reach MIRR of 5%	\$0.00	0.0%	0.00
● Rebate to Reach MIRR of 6%	\$0.00	0.0%	0.00
● Rebate to Reach MIRR of 7%	\$0.27	6.9%	0.88
● Rebate to Reach MIRR of 8%	\$0.67	8.0%	0.91
● Rebate to Reach MIRR of 9%	\$1.19	9.1%	0.94
● Rebate to Reach MIRR of 10%	\$1.69	9.9%	0.97
● Rebate to Reach MIRR of 11%	\$2.35	10.9%	1.02
● Rebate to Reach MIRR of 12%	\$0.00	0.0%	0.00
● Rebate to Reach MIRR of 13%	\$0.00	0.0%	0.00
● Rebate to Reach MIRR of 14%	\$0.00	0.0%	0.00
● Rebate to Reach MIRR of 15%	\$0.00	0.0%	0.00

System Cost per Watt: \$2.82

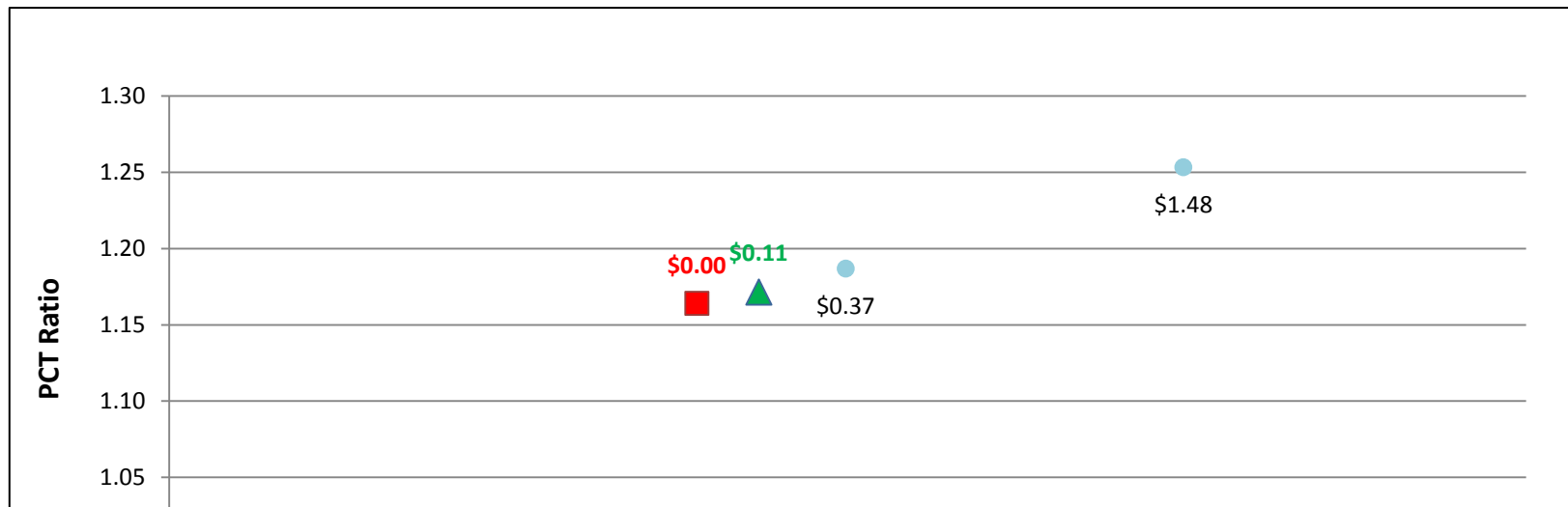


SGIP Cost Effectiveness Report
Participant Test Results (PCT)
MIRR Graphs

GTg3to7MW w/ Natural Gas - Commercial - SDG&E

	Rebate (\$/watt)	MIRR	PCT-2014
▲ Actual Rebate - 2014	\$0.11	13.7%	1.17
■ No Rebate	\$0.00	13.6%	1.16
● Rebate to Reach MIRR of 5%	\$0.00	0.0%	0.00
● Rebate to Reach MIRR of 6%	\$0.00	0.0%	0.00
● Rebate to Reach MIRR of 7%	\$0.00	0.0%	0.00
● Rebate to Reach MIRR of 8%	\$0.00	0.0%	0.00
● Rebate to Reach MIRR of 9%	\$0.00	0.0%	0.00
● Rebate to Reach MIRR of 10%	\$0.00	0.0%	0.00
● Rebate to Reach MIRR of 11%	\$0.00	0.0%	0.00
● Rebate to Reach MIRR of 12%	\$0.00	0.0%	0.00
● Rebate to Reach MIRR of 13%	\$0.00	0.0%	0.00
● Rebate to Reach MIRR of 14%	\$0.37	14.0%	1.19
● Rebate to Reach MIRR of 15%	\$1.48	15.0%	1.25

System Cost per Watt: \$2.82

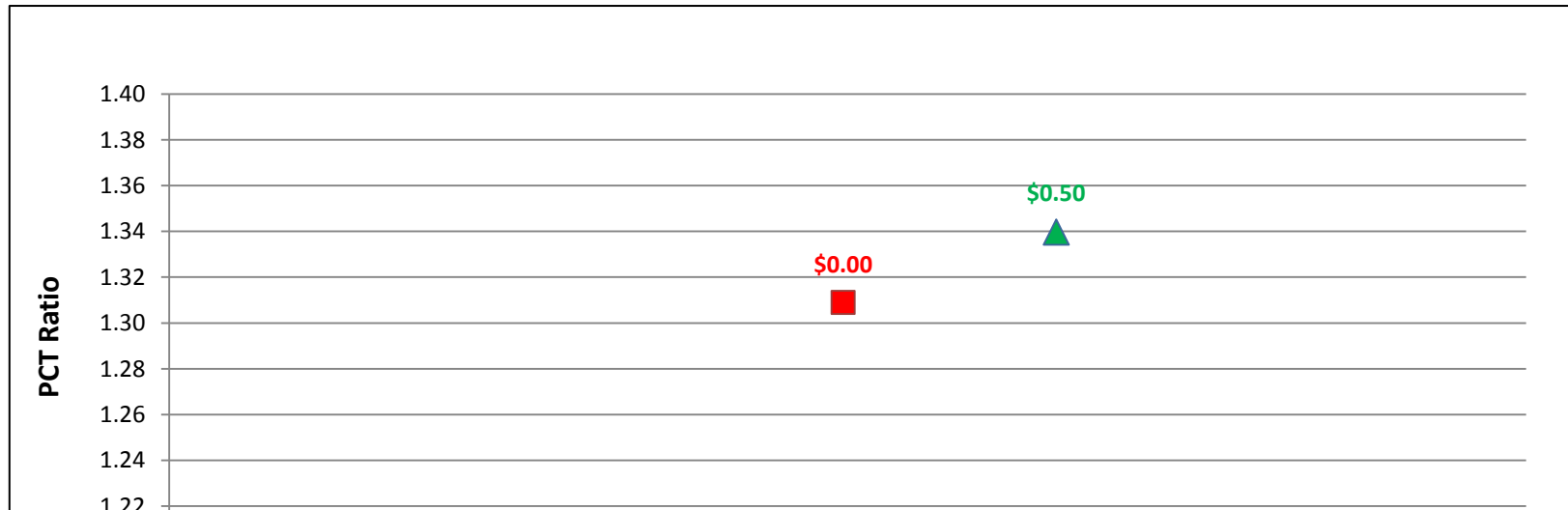


SGIP Cost Effectiveness Report
Participant Test Results (PCT)
MIRR Graphs

GTg3to7MW w/ On-Site BioGas - Commercial - PG&E

	Rebate (\$/watt)	MIRR	PCT-2014
▲ Actual Rebate - 2014	\$0.50	15.6%	1.34
■ No Rebate	\$0.00	15.0%	1.31
● Rebate to Reach MIRR of 5%	\$0.00	0.0%	0.00
● Rebate to Reach MIRR of 6%	\$0.00	0.0%	0.00
● Rebate to Reach MIRR of 7%	\$0.00	0.0%	0.00
● Rebate to Reach MIRR of 8%	\$0.00	0.0%	0.00
● Rebate to Reach MIRR of 9%	\$0.00	0.0%	0.00
● Rebate to Reach MIRR of 10%	\$0.00	0.0%	0.00
● Rebate to Reach MIRR of 11%	\$0.00	0.0%	0.00
● Rebate to Reach MIRR of 12%	\$0.00	0.0%	0.00
● Rebate to Reach MIRR of 13%	\$0.00	0.0%	0.00
● Rebate to Reach MIRR of 14%	\$0.00	0.0%	0.00
● Rebate to Reach MIRR of 15%	\$0.00	0.0%	0.00

System Cost per Watt: \$3.57

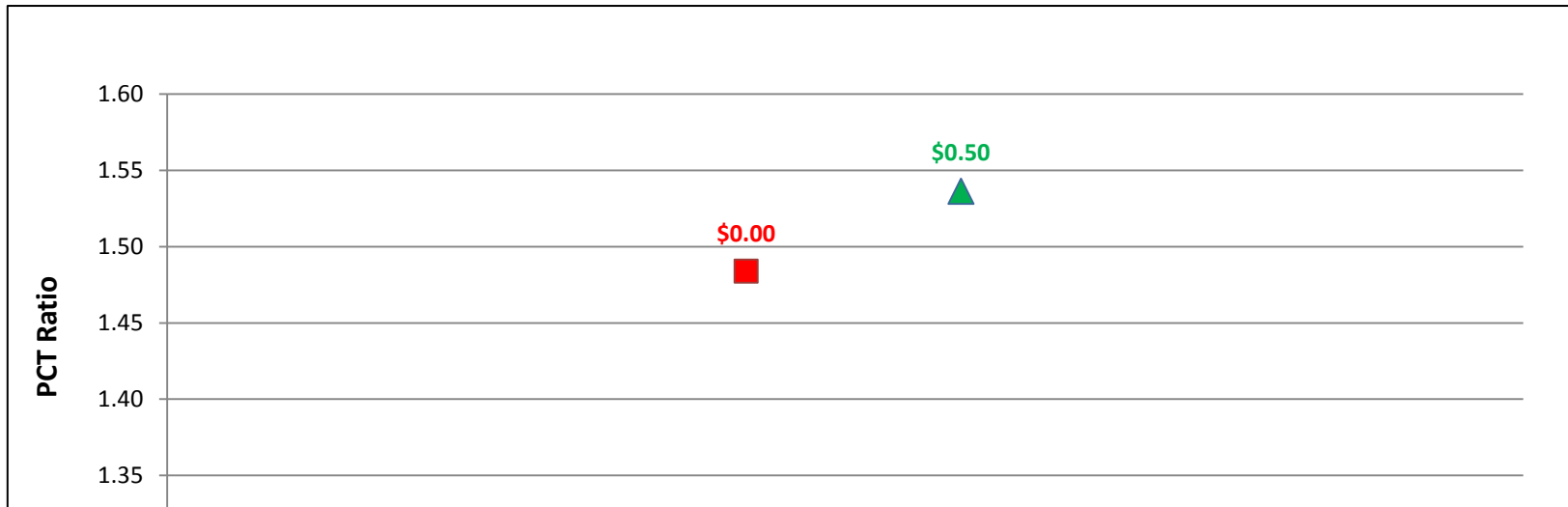


SGIP Cost Effectiveness Report
Participant Test Results (PCT)
MIRR Graphs

GTg3to7MW w/ On-Site BioGas - Commercial - SCE

	Rebate (\$/watt)	MIRR	PCT-2014
▲ Actual Rebate - 2014	\$0.50	15.3%	1.54
■ No Rebate	\$0.00	14.7%	1.48
● Rebate to Reach MIRR of 5%	\$0.00	0.0%	0.00
● Rebate to Reach MIRR of 6%	\$0.00	0.0%	0.00
● Rebate to Reach MIRR of 7%	\$0.00	0.0%	0.00
● Rebate to Reach MIRR of 8%	\$0.00	0.0%	0.00
● Rebate to Reach MIRR of 9%	\$0.00	0.0%	0.00
● Rebate to Reach MIRR of 10%	\$0.00	0.0%	0.00
● Rebate to Reach MIRR of 11%	\$0.00	0.0%	0.00
● Rebate to Reach MIRR of 12%	\$0.00	0.0%	0.00
● Rebate to Reach MIRR of 13%	\$0.00	0.0%	0.00
● Rebate to Reach MIRR of 14%	\$0.00	0.0%	0.00
● Rebate to Reach MIRR of 15%	\$0.00	0.0%	0.00

System Cost per Watt: \$3.57

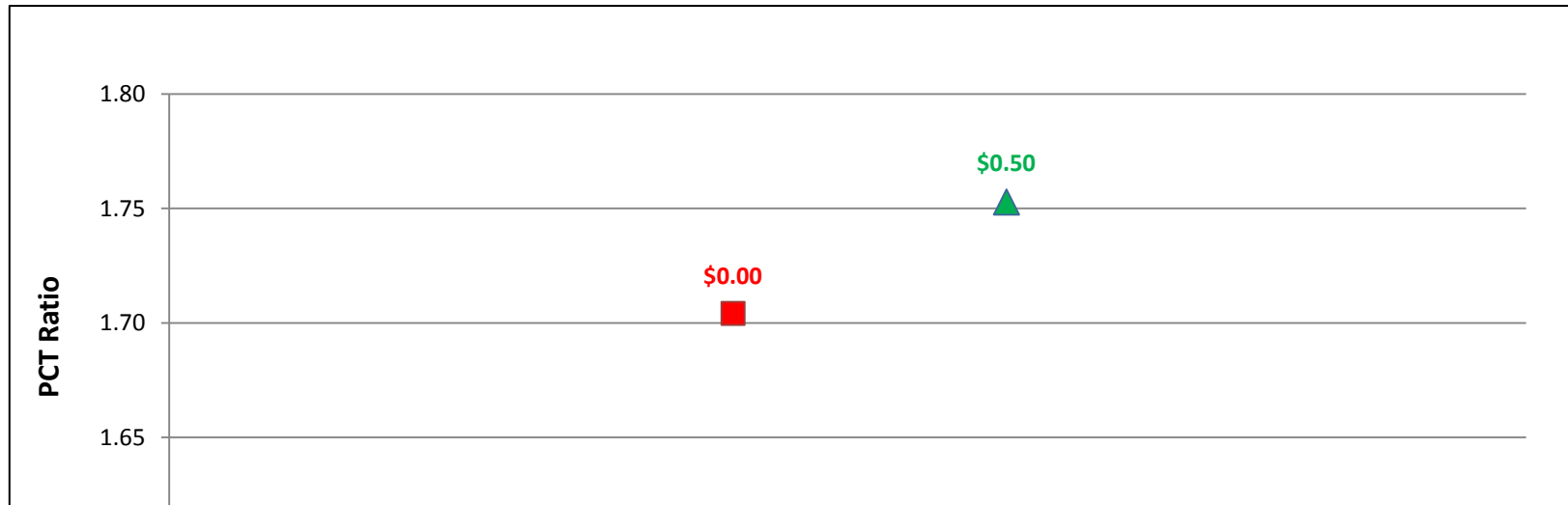


SGIP Cost Effectiveness Report
Participant Test Results (PCT)
MIRR Graphs

GTg3to7MW w/ On-Site BioGas - Commercial - SDG&E

	Rebate (\$/watt)	MIRR	PCT-2014
▲ Actual Rebate - 2014	\$0.50	16.9%	1.75
■ No Rebate	\$0.00	16.2%	1.70
● Rebate to Reach MIRR of 5%	\$0.00	0.0%	0.00
● Rebate to Reach MIRR of 6%	\$0.00	0.0%	0.00
● Rebate to Reach MIRR of 7%	\$0.00	0.0%	0.00
● Rebate to Reach MIRR of 8%	\$0.00	0.0%	0.00
● Rebate to Reach MIRR of 9%	\$0.00	0.0%	0.00
● Rebate to Reach MIRR of 10%	\$0.00	0.0%	0.00
● Rebate to Reach MIRR of 11%	\$0.00	0.0%	0.00
● Rebate to Reach MIRR of 12%	\$0.00	0.0%	0.00
● Rebate to Reach MIRR of 13%	\$0.00	0.0%	0.00
● Rebate to Reach MIRR of 14%	\$0.00	0.0%	0.00
● Rebate to Reach MIRR of 15%	\$0.00	0.0%	0.00

System Cost per Watt: \$3.57



SGIP Cost Effectiveness Report
Participant Test Results (PCT)
MIRR Graphs

GTle3MW w/ Directed BioGas - Government/Non-Profit - PG&E

	Rebate (\$/watt)	MIRR	PCT-2014
▲ Actual Rebate - 2014	\$1.31	-100.0%	0.87
■ No Rebate	\$0.00	-100.0%	0.82
● Rebate to Reach MIRR of 5%	\$0.00	0.0%	0.00
● Rebate to Reach MIRR of 6%	\$0.00	0.0%	0.00
● Rebate to Reach MIRR of 7%	\$0.00	0.0%	0.00
● Rebate to Reach MIRR of 8%	\$0.00	0.0%	0.00
● Rebate to Reach MIRR of 9%	\$0.00	0.0%	0.00
● Rebate to Reach MIRR of 10%	\$0.00	0.0%	0.00
● Rebate to Reach MIRR of 11%	\$0.00	0.0%	0.00
● Rebate to Reach MIRR of 12%	\$0.00	0.0%	0.00
● Rebate to Reach MIRR of 13%	\$0.00	0.0%	0.00
● Rebate to Reach MIRR of 14%	\$0.00	0.0%	0.00
● Rebate to Reach MIRR of 15%	\$0.00	0.0%	0.00

System Cost per Watt: \$2.97



SGIP Cost Effectiveness Report
 Participant Test Results (PCT)
 MIRR Graphs

GTle3MW w/ Directed BioGas - Government/Non-Profit - SCE

	Rebate (\$/watt)	MIRR	PCT-2014
▲ Actual Rebate - 2014	\$1.31	-100.0%	0.63
■ No Rebate	\$0.00	-100.0%	0.57
● Rebate to Reach MIRR of 5%	\$0.00	0.0%	0.00
● Rebate to Reach MIRR of 6%	\$0.00	0.0%	0.00
● Rebate to Reach MIRR of 7%	\$0.00	0.0%	0.00
● Rebate to Reach MIRR of 8%	\$0.00	0.0%	0.00
● Rebate to Reach MIRR of 9%	\$0.00	0.0%	0.00
● Rebate to Reach MIRR of 10%	\$0.00	0.0%	0.00
● Rebate to Reach MIRR of 11%	\$0.00	0.0%	0.00
● Rebate to Reach MIRR of 12%	\$0.00	0.0%	0.00
● Rebate to Reach MIRR of 13%	\$0.00	0.0%	0.00
● Rebate to Reach MIRR of 14%	\$0.00	0.0%	0.00
● Rebate to Reach MIRR of 15%	\$0.00	0.0%	0.00

System Cost per Watt: \$2.97



SGIP Cost Effectiveness Report
 Participant Test Results (PCT)
 MIRR Graphs

GTle3MW w/ Directed BioGas - Government/Non-Profit - SDG&E

	Rebate (\$/watt)	MIRR	PCT-2014
▲ Actual Rebate - 2014	\$1.31	-100.0%	0.85
■ No Rebate	\$0.00	-100.0%	0.79
● Rebate to Reach MIRR of 5%	\$0.00	0.0%	0.00
● Rebate to Reach MIRR of 6%	\$0.00	0.0%	0.00
● Rebate to Reach MIRR of 7%	\$0.00	0.0%	0.00
● Rebate to Reach MIRR of 8%	\$0.00	0.0%	0.00
● Rebate to Reach MIRR of 9%	\$0.00	0.0%	0.00
● Rebate to Reach MIRR of 10%	\$0.00	0.0%	0.00
● Rebate to Reach MIRR of 11%	\$0.00	0.0%	0.00
● Rebate to Reach MIRR of 12%	\$0.00	0.0%	0.00
● Rebate to Reach MIRR of 13%	\$0.00	0.0%	0.00
● Rebate to Reach MIRR of 14%	\$0.00	0.0%	0.00
● Rebate to Reach MIRR of 15%	\$0.00	0.0%	0.00

System Cost per Watt: \$2.97

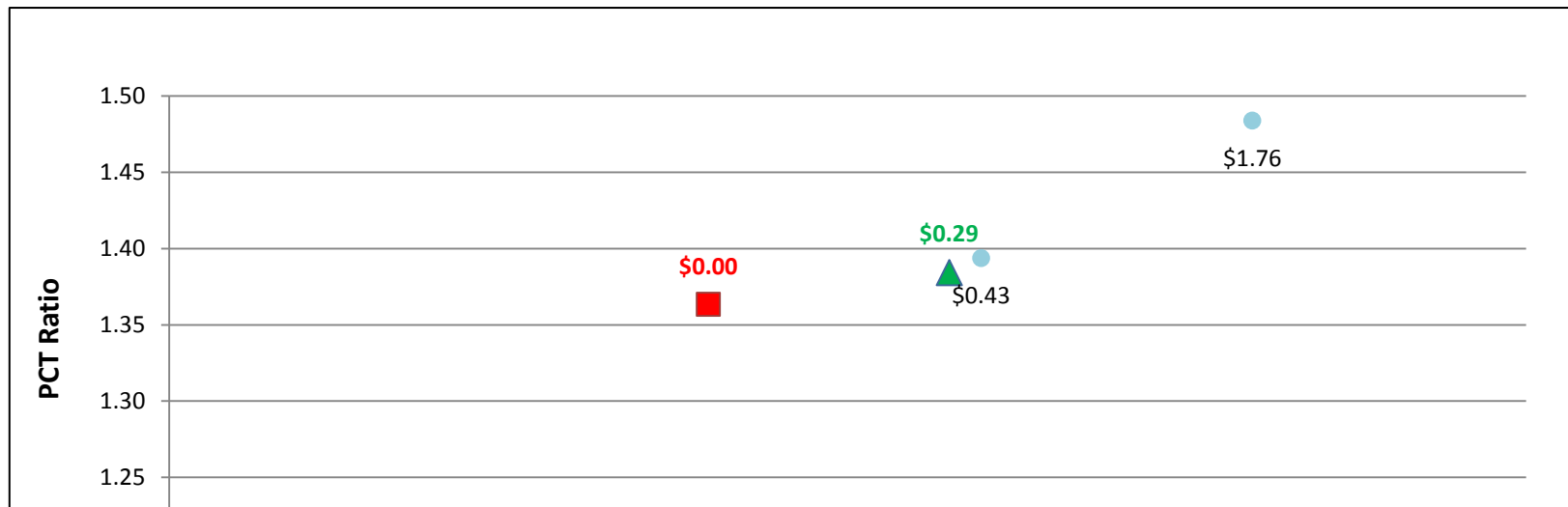


SGIP Cost Effectiveness Report
Participant Test Results (PCT)
MIRR Graphs

GTle3MW w/ Natural Gas - Government/Non-Profit - PG&E

	Rebate (\$/watt)	MIRR	PCT-2014
▲ Actual Rebate - 2014	\$0.29	13.9%	1.38
■ No Rebate	\$0.00	13.0%	1.36
● Rebate to Reach MIRR of 5%	\$0.00	0.0%	0.00
● Rebate to Reach MIRR of 6%	\$0.00	0.0%	0.00
● Rebate to Reach MIRR of 7%	\$0.00	0.0%	0.00
● Rebate to Reach MIRR of 8%	\$0.00	0.0%	0.00
● Rebate to Reach MIRR of 9%	\$0.00	0.0%	0.00
● Rebate to Reach MIRR of 10%	\$0.00	0.0%	0.00
● Rebate to Reach MIRR of 11%	\$0.00	0.0%	0.00
● Rebate to Reach MIRR of 12%	\$0.00	0.0%	0.00
● Rebate to Reach MIRR of 13%	\$0.00	0.0%	0.00
● Rebate to Reach MIRR of 14%	\$0.43	14.0%	1.39
● Rebate to Reach MIRR of 15%	\$1.76	15.0%	1.48

System Cost per Watt: \$2.95

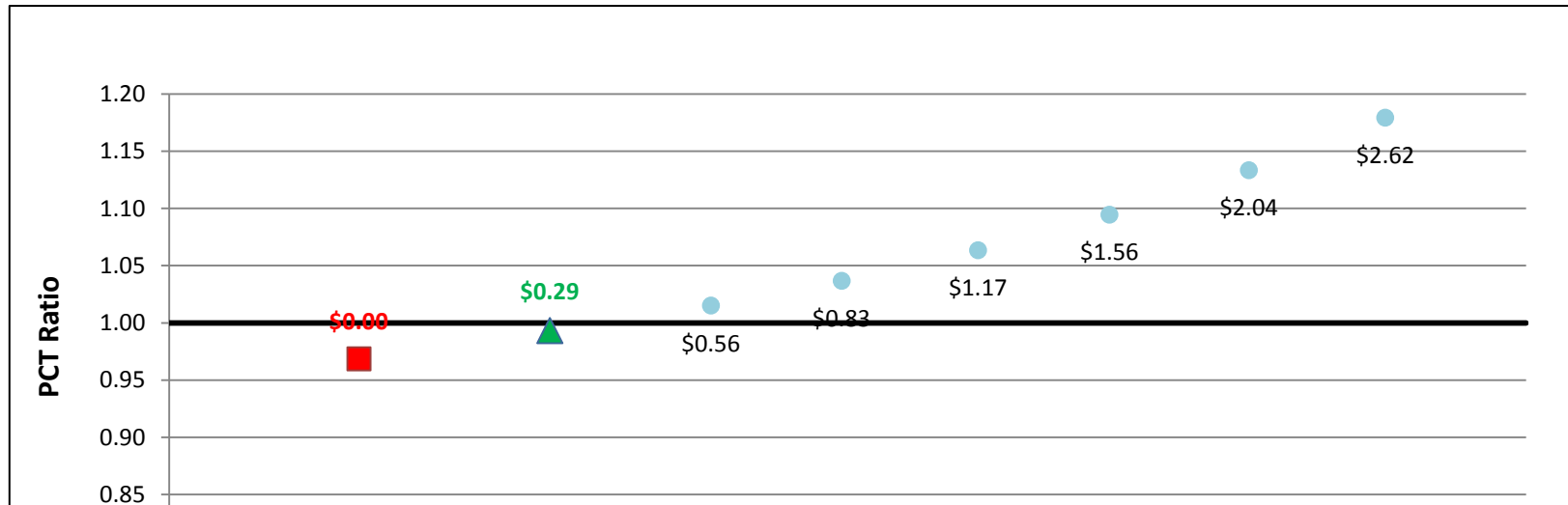


SGIP Cost Effectiveness Report
Participant Test Results (PCT)
MIRR Graphs

GTle3MW w/ Natural Gas - Government/Non-Profit - SCE

	Rebate (\$/watt)	MIRR	PCT-2014
▲ Actual Rebate - 2014	\$0.29	3.8%	0.99
■ No Rebate	\$0.00	2.4%	0.97
● Rebate to Reach MIRR of 5%	\$0.56	5.0%	1.01
● Rebate to Reach MIRR of 6%	\$0.83	6.0%	1.04
● Rebate to Reach MIRR of 7%	\$1.17	7.0%	1.06
● Rebate to Reach MIRR of 8%	\$1.56	7.9%	1.09
● Rebate to Reach MIRR of 9%	\$2.04	9.0%	1.13
● Rebate to Reach MIRR of 10%	\$2.62	10.0%	1.18
● Rebate to Reach MIRR of 11%	\$0.00	0.0%	0.00
● Rebate to Reach MIRR of 12%	\$0.00	0.0%	0.00
● Rebate to Reach MIRR of 13%	\$0.00	0.0%	0.00
● Rebate to Reach MIRR of 14%	\$0.00	0.0%	0.00
● Rebate to Reach MIRR of 15%	\$0.00	0.0%	0.00

System Cost per Watt: \$2.95

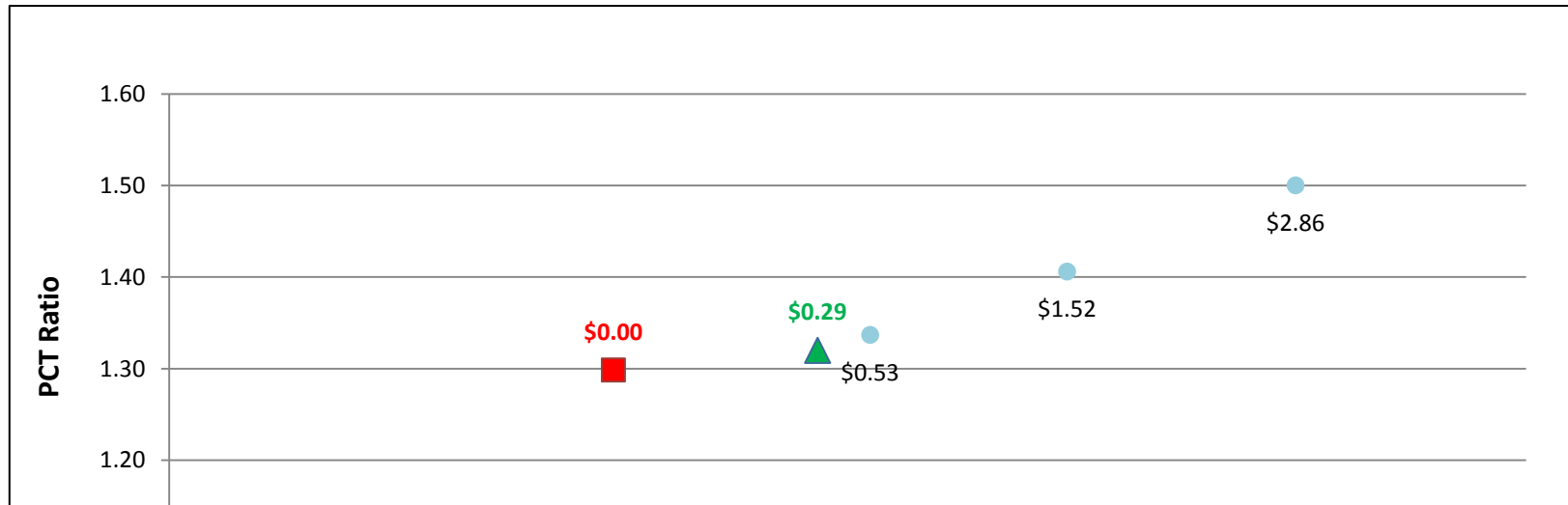


SGIP Cost Effectiveness Report
Participant Test Results (PCT)
MIRR Graphs

GTle3MW w/ Natural Gas - Government/Non-Profit - SDG&E

	Rebate (\$/watt)	MIRR	PCT-2014
▲ Actual Rebate - 2014	\$0.29	12.9%	1.32
■ No Rebate	\$0.00	12.0%	1.30
● Rebate to Reach MIRR of 5%	\$0.00	0.0%	0.00
● Rebate to Reach MIRR of 6%	\$0.00	0.0%	0.00
● Rebate to Reach MIRR of 7%	\$0.00	0.0%	0.00
● Rebate to Reach MIRR of 8%	\$0.00	0.0%	0.00
● Rebate to Reach MIRR of 9%	\$0.00	0.0%	0.00
● Rebate to Reach MIRR of 10%	\$0.00	0.0%	0.00
● Rebate to Reach MIRR of 11%	\$0.00	0.0%	0.00
● Rebate to Reach MIRR of 12%	\$0.00	0.0%	0.00
● Rebate to Reach MIRR of 13%	\$0.53	13.1%	1.34
● Rebate to Reach MIRR of 14%	\$1.52	14.0%	1.41
● Rebate to Reach MIRR of 15%	\$2.86	15.0%	1.50

System Cost per Watt: \$2.95

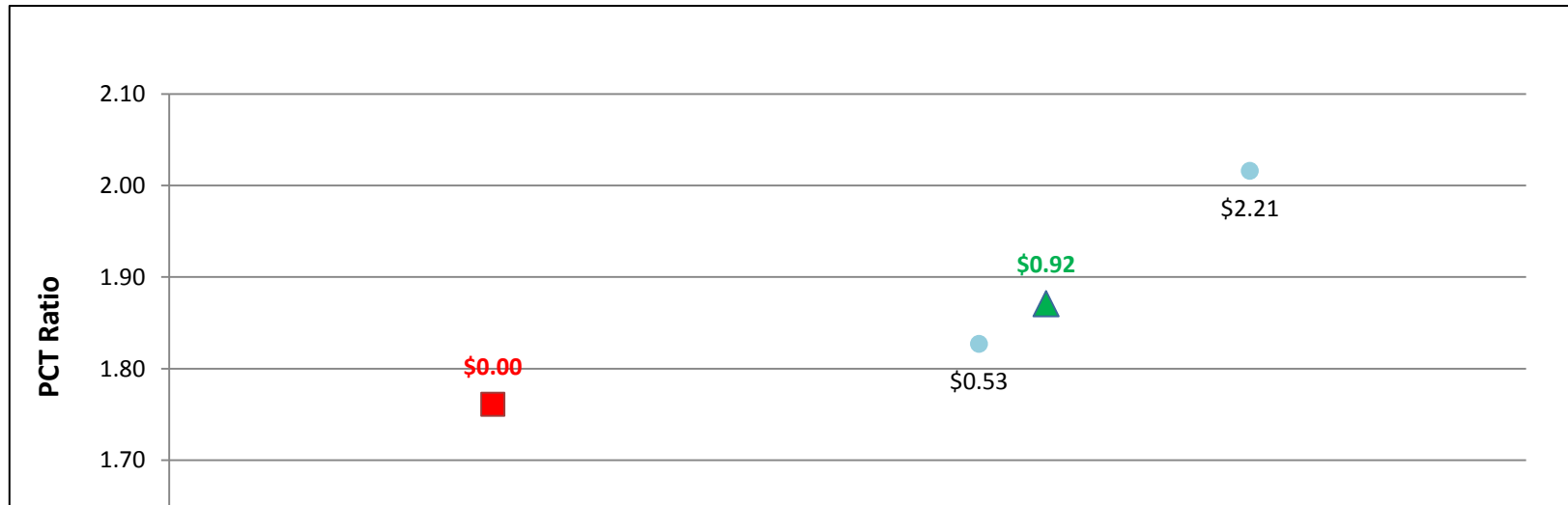


SGIP Cost Effectiveness Report
Participant Test Results (PCT)
MIRR Graphs

GTle3MW w/ On-Site BioGas - Government/Non-Profit - PG&E

	Rebate (\$/watt)	MIRR	PCT-2014
▲ Actual Rebate - 2014	\$0.92	14.2%	1.87
■ No Rebate	\$0.00	12.2%	1.76
● Rebate to Reach MIRR of 5%	\$0.00	0.0%	0.00
● Rebate to Reach MIRR of 6%	\$0.00	0.0%	0.00
● Rebate to Reach MIRR of 7%	\$0.00	0.0%	0.00
● Rebate to Reach MIRR of 8%	\$0.00	0.0%	0.00
● Rebate to Reach MIRR of 9%	\$0.00	0.0%	0.00
● Rebate to Reach MIRR of 10%	\$0.00	0.0%	0.00
● Rebate to Reach MIRR of 11%	\$0.00	0.0%	0.00
● Rebate to Reach MIRR of 12%	\$0.00	0.0%	0.00
● Rebate to Reach MIRR of 13%	\$0.00	0.0%	0.00
● Rebate to Reach MIRR of 14%	\$0.53	14.0%	1.83
● Rebate to Reach MIRR of 15%	\$2.21	15.0%	2.02

System Cost per Watt: \$4.43

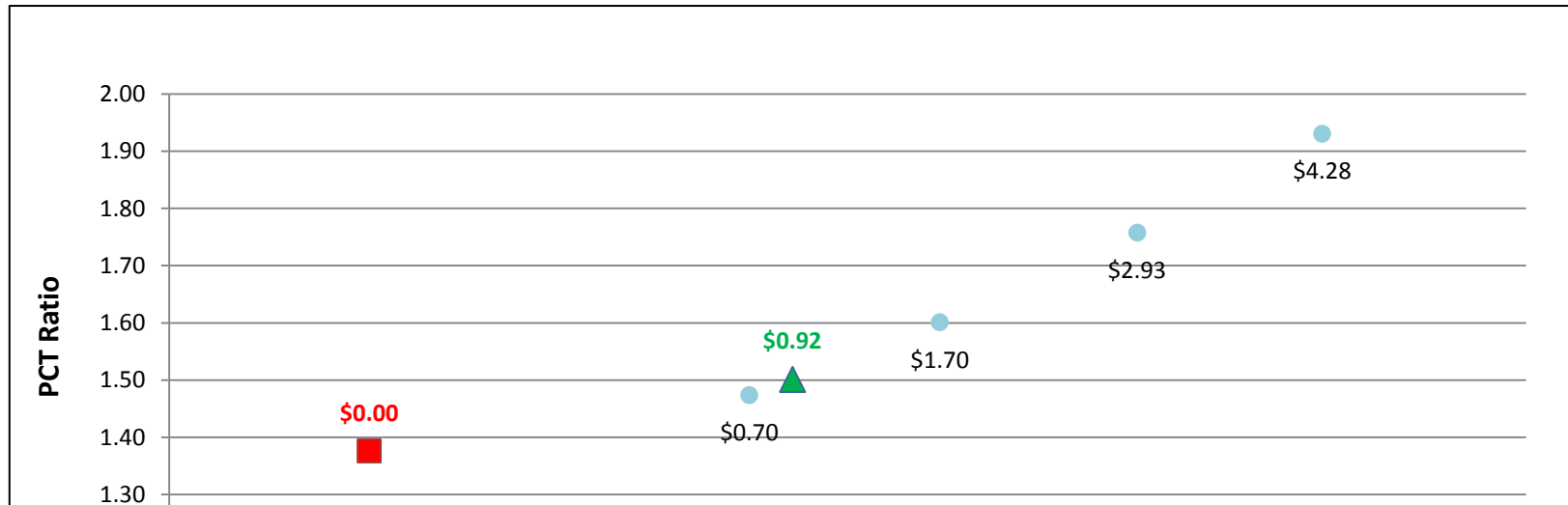


SGIP Cost Effectiveness Report
Participant Test Results (PCT)
MIRR Graphs

GTle3MW w/ On-Site BioGas - Government/Non-Profit - SCE

	Rebate (\$/watt)	MIRR	PCT-2014
▲ Actual Rebate - 2014	\$0.92	11.2%	1.50
■ No Rebate	\$0.00	9.0%	1.38
● Rebate to Reach MIRR of 5%	\$0.00	0.0%	0.00
● Rebate to Reach MIRR of 6%	\$0.00	0.0%	0.00
● Rebate to Reach MIRR of 7%	\$0.00	0.0%	0.00
● Rebate to Reach MIRR of 8%	\$0.00	0.0%	0.00
● Rebate to Reach MIRR of 9%	\$0.00	0.0%	0.00
● Rebate to Reach MIRR of 10%	\$0.00	0.0%	0.00
● Rebate to Reach MIRR of 11%	\$0.70	11.0%	1.47
● Rebate to Reach MIRR of 12%	\$1.70	12.0%	1.60
● Rebate to Reach MIRR of 13%	\$2.93	13.0%	1.76
● Rebate to Reach MIRR of 14%	\$4.28	13.9%	1.93
● Rebate to Reach MIRR of 15%	\$0.00	0.0%	0.00

System Cost per Watt: \$4.43

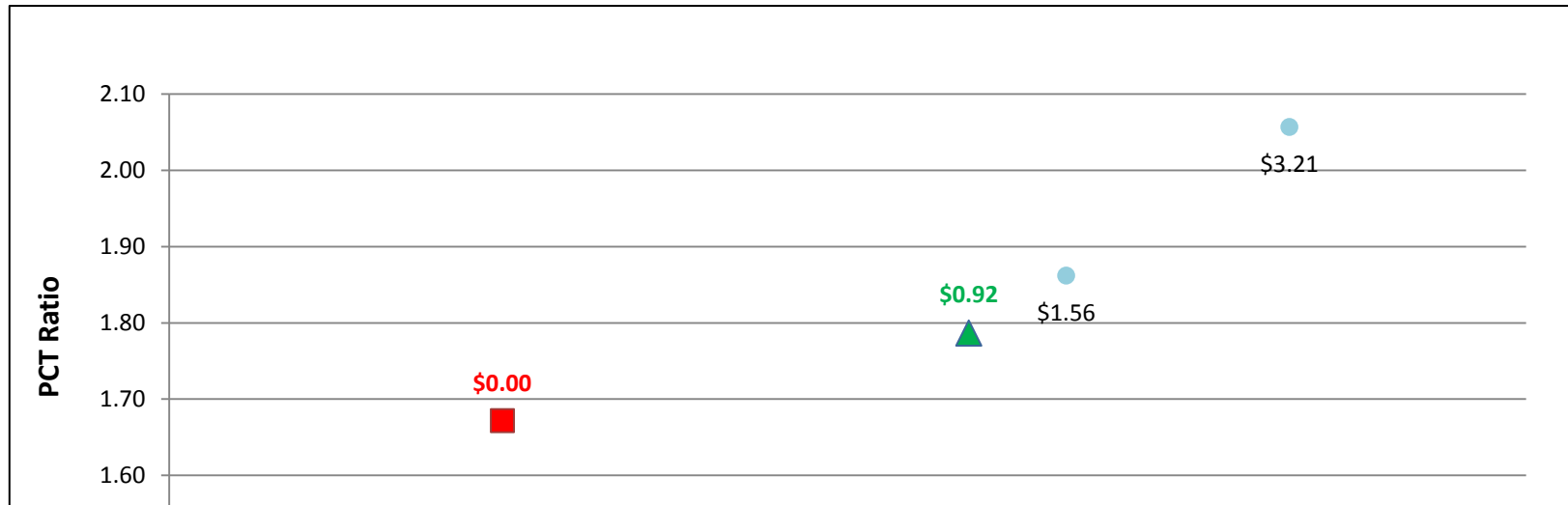


SGIP Cost Effectiveness Report
Participant Test Results (PCT)
MIRR Graphs

GTle3MW w/ On-Site BioGas - Government/Non-Profit - SDG&E

	Rebate (\$/watt)	MIRR	PCT-2014
▲ Actual Rebate - 2014	\$0.92	13.5%	1.79
■ No Rebate	\$0.00	11.5%	1.67
● Rebate to Reach MIRR of 5%	\$0.00	0.0%	0.00
● Rebate to Reach MIRR of 6%	\$0.00	0.0%	0.00
● Rebate to Reach MIRR of 7%	\$0.00	0.0%	0.00
● Rebate to Reach MIRR of 8%	\$0.00	0.0%	0.00
● Rebate to Reach MIRR of 9%	\$0.00	0.0%	0.00
● Rebate to Reach MIRR of 10%	\$0.00	0.0%	0.00
● Rebate to Reach MIRR of 11%	\$0.00	0.0%	0.00
● Rebate to Reach MIRR of 12%	\$0.00	0.0%	0.00
● Rebate to Reach MIRR of 13%	\$0.00	0.0%	0.00
● Rebate to Reach MIRR of 14%	\$1.56	14.0%	1.86
● Rebate to Reach MIRR of 15%	\$3.21	15.0%	2.06

System Cost per Watt: \$4.43

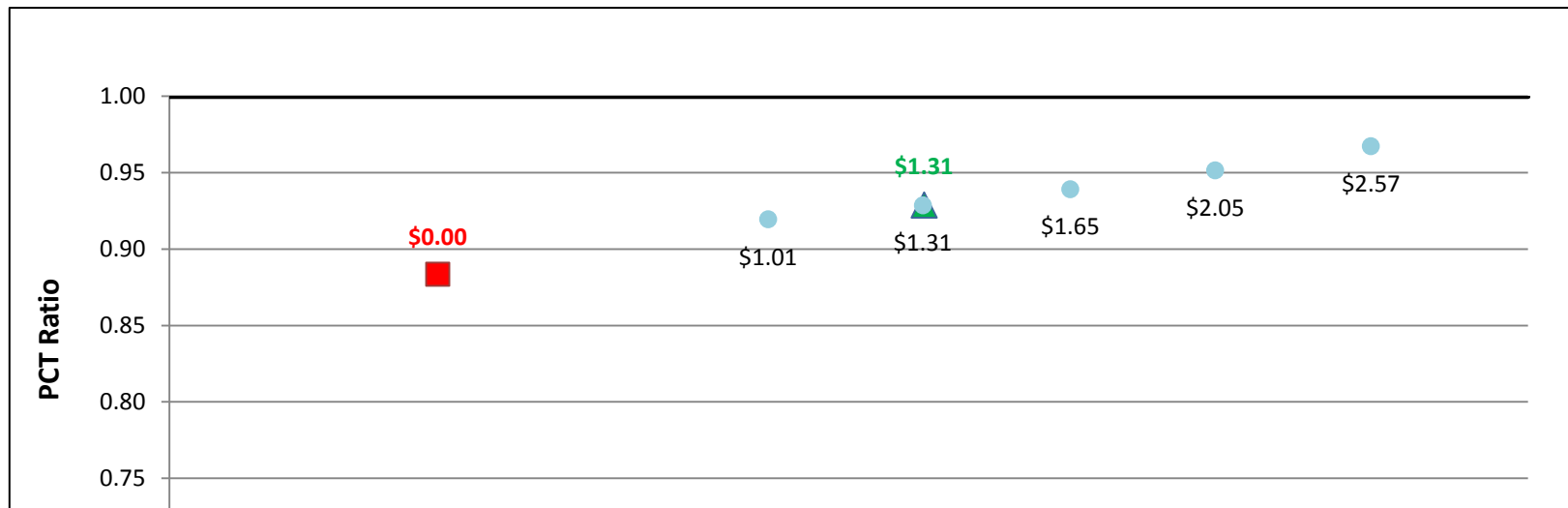


SGIP Cost Effectiveness Report
Participant Test Results (PCT)
MIRR Graphs

GTle3MW w/ Directed BioGas - Commercial - PG&E

	Rebate (\$/watt)	MIRR	PCT-2014
▲ Actual Rebate - 2014	\$1.31	6.0%	0.93
■ No Rebate	\$0.00	2.8%	0.88
● Rebate to Reach MIRR of 5%	\$1.01	5.0%	0.92
● Rebate to Reach MIRR of 6%	\$1.31	6.0%	0.93
● Rebate to Reach MIRR of 7%	\$1.65	7.0%	0.94
● Rebate to Reach MIRR of 8%	\$2.05	7.9%	0.95
● Rebate to Reach MIRR of 9%	\$2.57	9.0%	0.97
● Rebate to Reach MIRR of 10%	\$0.00	0.0%	0.00
● Rebate to Reach MIRR of 11%	\$0.00	0.0%	0.00
● Rebate to Reach MIRR of 12%	\$0.00	0.0%	0.00
● Rebate to Reach MIRR of 13%	\$0.00	0.0%	0.00
● Rebate to Reach MIRR of 14%	\$0.00	0.0%	0.00
● Rebate to Reach MIRR of 15%	\$0.00	0.0%	0.00

System Cost per Watt: \$2.97



SGIP Cost Effectiveness Report
Participant Test Results (PCT)
MIRR Graphs

GTle3MW w/ Directed BioGas - Commercial - SCE

	Rebate (\$/watt)	MIRR	PCT-2014
▲ Actual Rebate - 2014	\$1.31	-1.8%	0.79
■ No Rebate	\$0.00	-5.7%	0.74
● Rebate to Reach MIRR of 5%	\$0.00	0.0%	0.00
● Rebate to Reach MIRR of 6%	\$0.00	0.0%	0.00
● Rebate to Reach MIRR of 7%	\$0.00	0.0%	0.00
● Rebate to Reach MIRR of 8%	\$0.00	0.0%	0.00
● Rebate to Reach MIRR of 9%	\$0.00	0.0%	0.00
● Rebate to Reach MIRR of 10%	\$0.00	0.0%	0.00
● Rebate to Reach MIRR of 11%	\$0.00	0.0%	0.00
● Rebate to Reach MIRR of 12%	\$0.00	0.0%	0.00
● Rebate to Reach MIRR of 13%	\$0.00	0.0%	0.00
● Rebate to Reach MIRR of 14%	\$0.00	0.0%	0.00
● Rebate to Reach MIRR of 15%	\$0.00	0.0%	0.00

System Cost per Watt: \$2.97

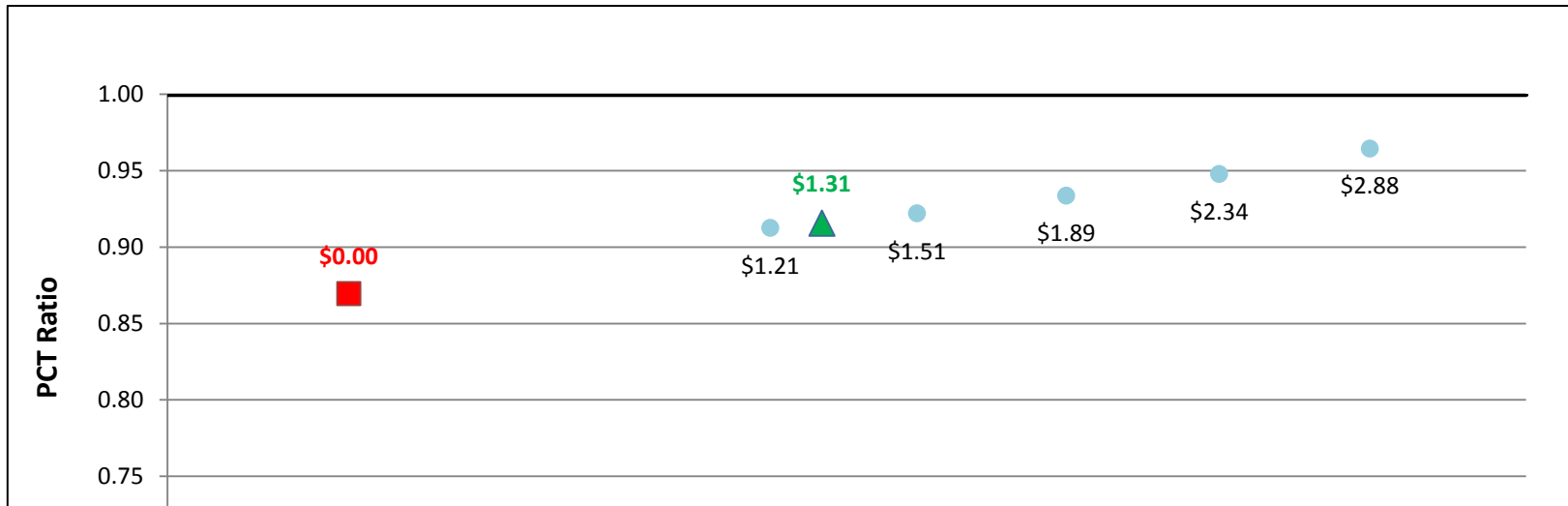


SGIP Cost Effectiveness Report
Participant Test Results (PCT)
MIRR Graphs

GTle3MW w/ Directed BioGas - Commercial - SDG&E

	Rebate (\$/watt)	MIRR	PCT-2014
▲ Actual Rebate - 2014	\$1.31	5.3%	0.92
■ No Rebate	\$0.00	2.2%	0.87
● Rebate to Reach MIRR of 5%	\$1.21	5.0%	0.91
● Rebate to Reach MIRR of 6%	\$1.51	6.0%	0.92
● Rebate to Reach MIRR of 7%	\$1.89	7.0%	0.93
● Rebate to Reach MIRR of 8%	\$2.34	8.0%	0.95
● Rebate to Reach MIRR of 9%	\$2.88	9.0%	0.96
● Rebate to Reach MIRR of 10%	\$0.00	0.0%	0.00
● Rebate to Reach MIRR of 11%	\$0.00	0.0%	0.00
● Rebate to Reach MIRR of 12%	\$0.00	0.0%	0.00
● Rebate to Reach MIRR of 13%	\$0.00	0.0%	0.00
● Rebate to Reach MIRR of 14%	\$0.00	0.0%	0.00
● Rebate to Reach MIRR of 15%	\$0.00	0.0%	0.00

System Cost per Watt: \$2.97

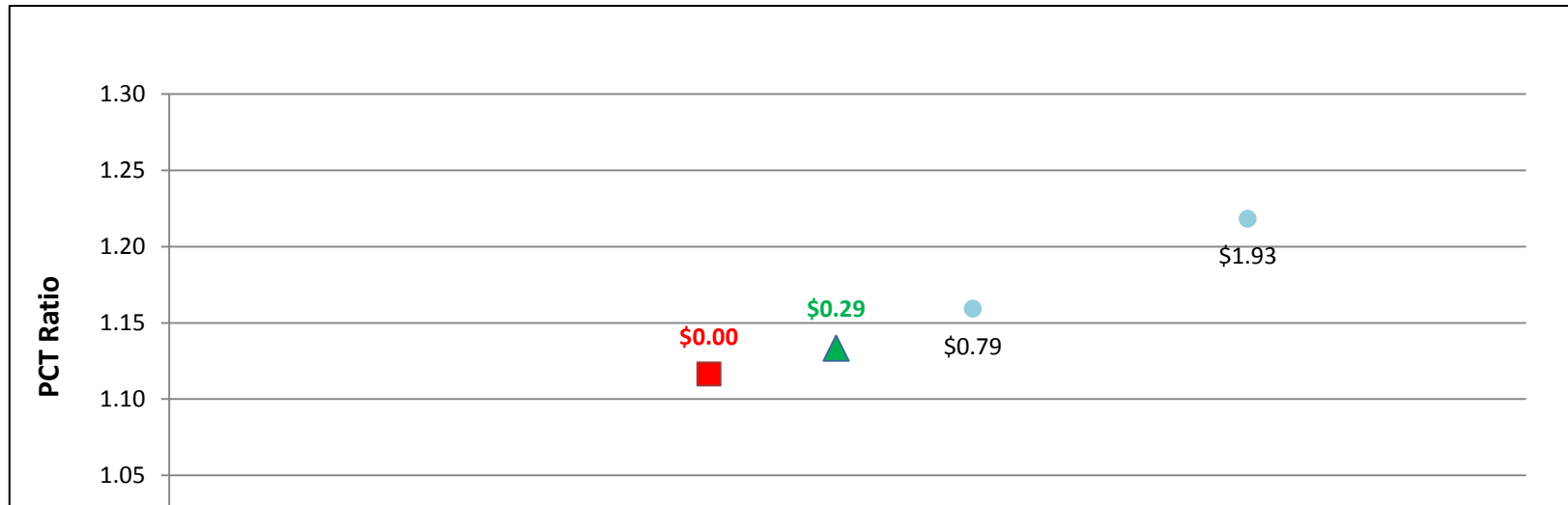


SGIP Cost Effectiveness Report
 Participant Test Results (PCT)
 MIRR Graphs

GTle3MW w/ Natural Gas - Commercial - PG&E

	Rebate (\$/watt)	MIRR	PCT-2014
▲ Actual Rebate - 2014	\$0.29	13.5%	1.13
■ No Rebate	\$0.00	13.0%	1.12
● Rebate to Reach MIRR of 5%	\$0.00	0.0%	0.00
● Rebate to Reach MIRR of 6%	\$0.00	0.0%	0.00
● Rebate to Reach MIRR of 7%	\$0.00	0.0%	0.00
● Rebate to Reach MIRR of 8%	\$0.00	0.0%	0.00
● Rebate to Reach MIRR of 9%	\$0.00	0.0%	0.00
● Rebate to Reach MIRR of 10%	\$0.00	0.0%	0.00
● Rebate to Reach MIRR of 11%	\$0.00	0.0%	0.00
● Rebate to Reach MIRR of 12%	\$0.00	0.0%	0.00
● Rebate to Reach MIRR of 13%	\$0.00	0.0%	0.00
● Rebate to Reach MIRR of 14%	\$0.79	14.0%	1.16
● Rebate to Reach MIRR of 15%	\$1.93	15.0%	1.22

System Cost per Watt: \$2.95

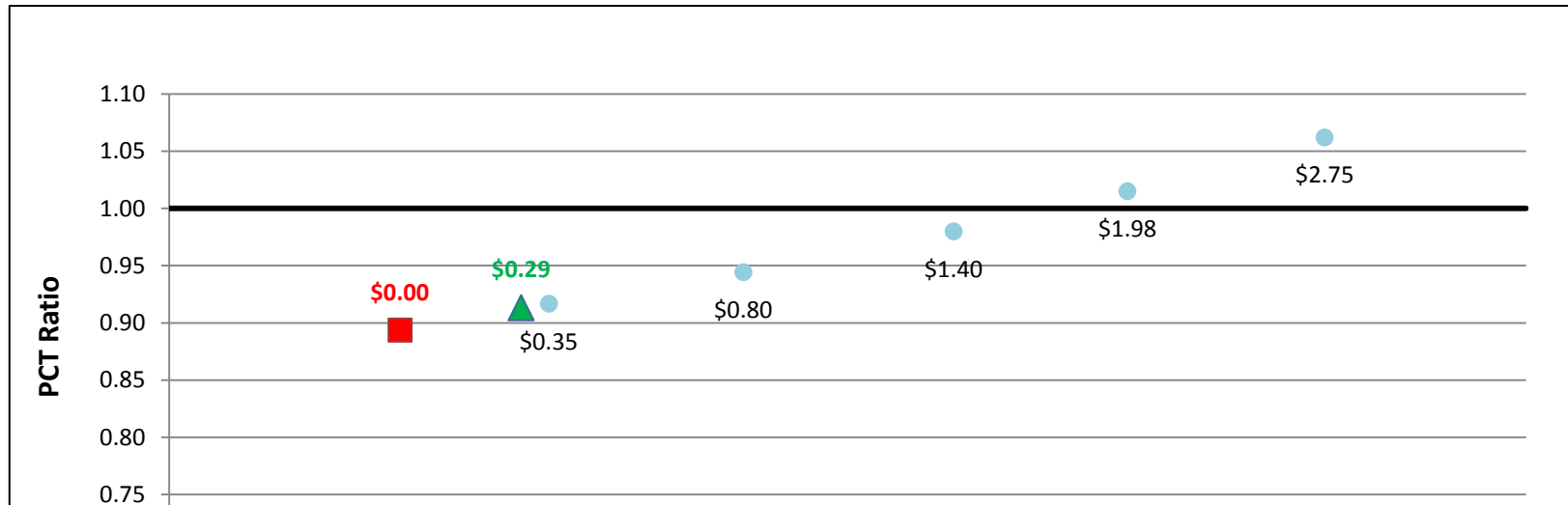


SGIP Cost Effectiveness Report
Participant Test Results (PCT)
MIRR Graphs

GTle3MW w/ Natural Gas - Commercial - SCE

	Rebate (\$/watt)	MIRR	PCT-2014
▲ Actual Rebate - 2014	\$0.29	7.8%	0.91
■ No Rebate	\$0.00	7.2%	0.89
● Rebate to Reach MIRR of 5%	\$0.00	0.0%	0.00
● Rebate to Reach MIRR of 6%	\$0.00	0.0%	0.00
● Rebate to Reach MIRR of 7%	\$0.00	0.0%	0.00
● Rebate to Reach MIRR of 8%	\$0.35	8.0%	0.92
● Rebate to Reach MIRR of 9%	\$0.80	9.0%	0.94
● Rebate to Reach MIRR of 10%	\$1.40	10.0%	0.98
● Rebate to Reach MIRR of 11%	\$1.98	10.9%	1.01
● Rebate to Reach MIRR of 12%	\$2.75	12.0%	1.06
● Rebate to Reach MIRR of 13%	\$0.00	0.0%	0.00
● Rebate to Reach MIRR of 14%	\$0.00	0.0%	0.00
● Rebate to Reach MIRR of 15%	\$0.00	0.0%	0.00

System Cost per Watt: \$2.95

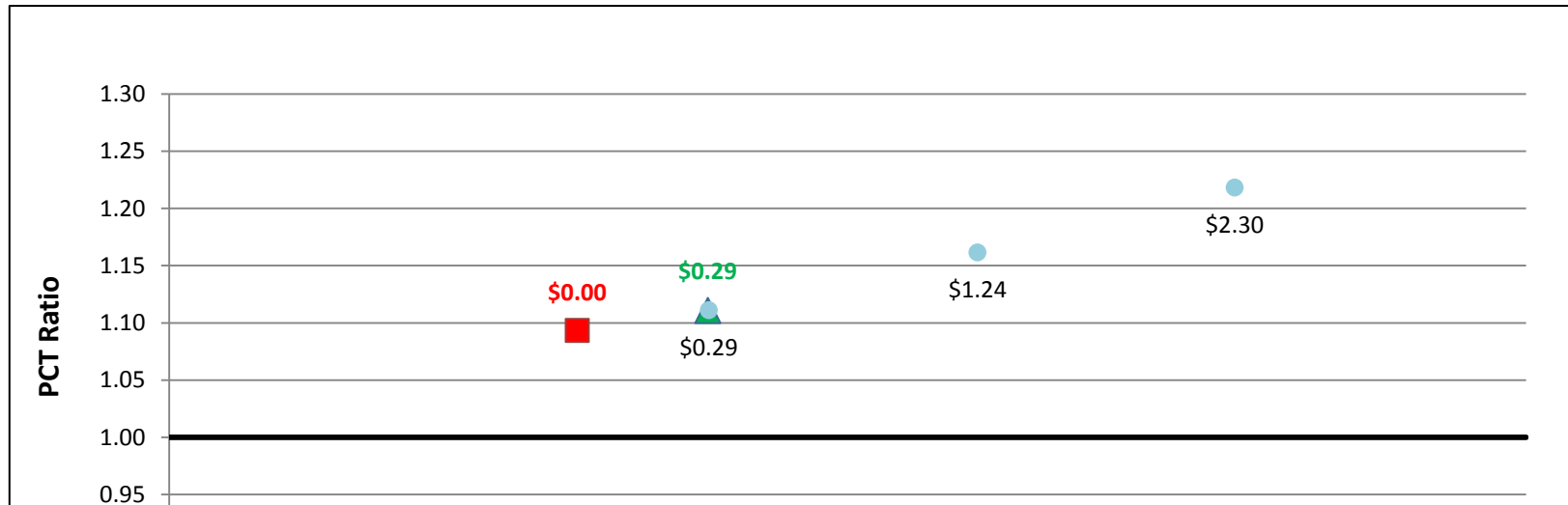


SGIP Cost Effectiveness Report
Participant Test Results (PCT)
MIRR Graphs

GTle3MW w/ Natural Gas - Commercial - SDG&E

	Rebate (\$/watt)	MIRR	PCT-2014
▲ Actual Rebate - 2014	\$0.29	13.0%	1.11
■ No Rebate	\$0.00	12.5%	1.09
● Rebate to Reach MIRR of 5%	\$0.00	0.0%	0.00
● Rebate to Reach MIRR of 6%	\$0.00	0.0%	0.00
● Rebate to Reach MIRR of 7%	\$0.00	0.0%	0.00
● Rebate to Reach MIRR of 8%	\$0.00	0.0%	0.00
● Rebate to Reach MIRR of 9%	\$0.00	0.0%	0.00
● Rebate to Reach MIRR of 10%	\$0.00	0.0%	0.00
● Rebate to Reach MIRR of 11%	\$0.00	0.0%	0.00
● Rebate to Reach MIRR of 12%	\$0.00	0.0%	0.00
● Rebate to Reach MIRR of 13%	\$0.29	13.0%	1.11
● Rebate to Reach MIRR of 14%	\$1.24	14.0%	1.16
● Rebate to Reach MIRR of 15%	\$2.30	14.9%	1.22

System Cost per Watt: \$2.95

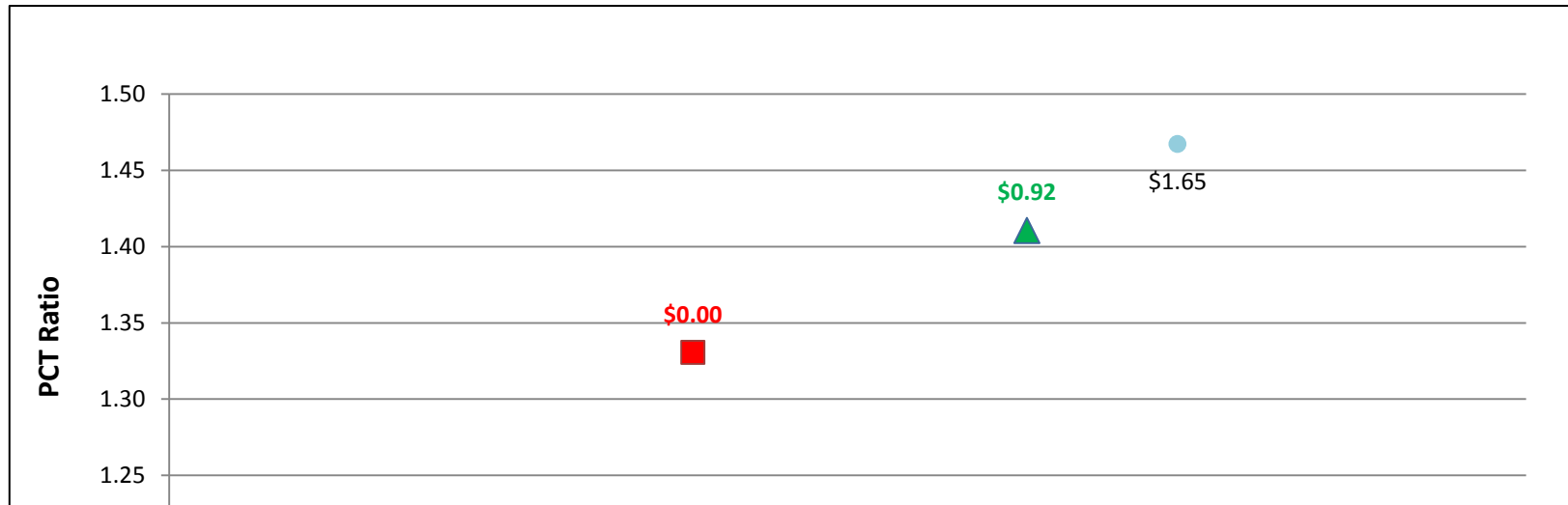


SGIP Cost Effectiveness Report
 Participant Test Results (PCT)
 MIRR Graphs

GTle3MW w/ On-Site BioGas - Commercial - PG&E

	Rebate (\$/watt)	MIRR	PCT-2014
▲ Actual Rebate - 2014	\$0.92	14.5%	1.41
■ No Rebate	\$0.00	13.5%	1.33
● Rebate to Reach MIRR of 5%	\$0.00	0.0%	0.00
● Rebate to Reach MIRR of 6%	\$0.00	0.0%	0.00
● Rebate to Reach MIRR of 7%	\$0.00	0.0%	0.00
● Rebate to Reach MIRR of 8%	\$0.00	0.0%	0.00
● Rebate to Reach MIRR of 9%	\$0.00	0.0%	0.00
● Rebate to Reach MIRR of 10%	\$0.00	0.0%	0.00
● Rebate to Reach MIRR of 11%	\$0.00	0.0%	0.00
● Rebate to Reach MIRR of 12%	\$0.00	0.0%	0.00
● Rebate to Reach MIRR of 13%	\$0.00	0.0%	0.00
● Rebate to Reach MIRR of 14%	\$0.00	0.0%	0.00
● Rebate to Reach MIRR of 15%	\$1.65	15.0%	1.47

System Cost per Watt: \$4.43

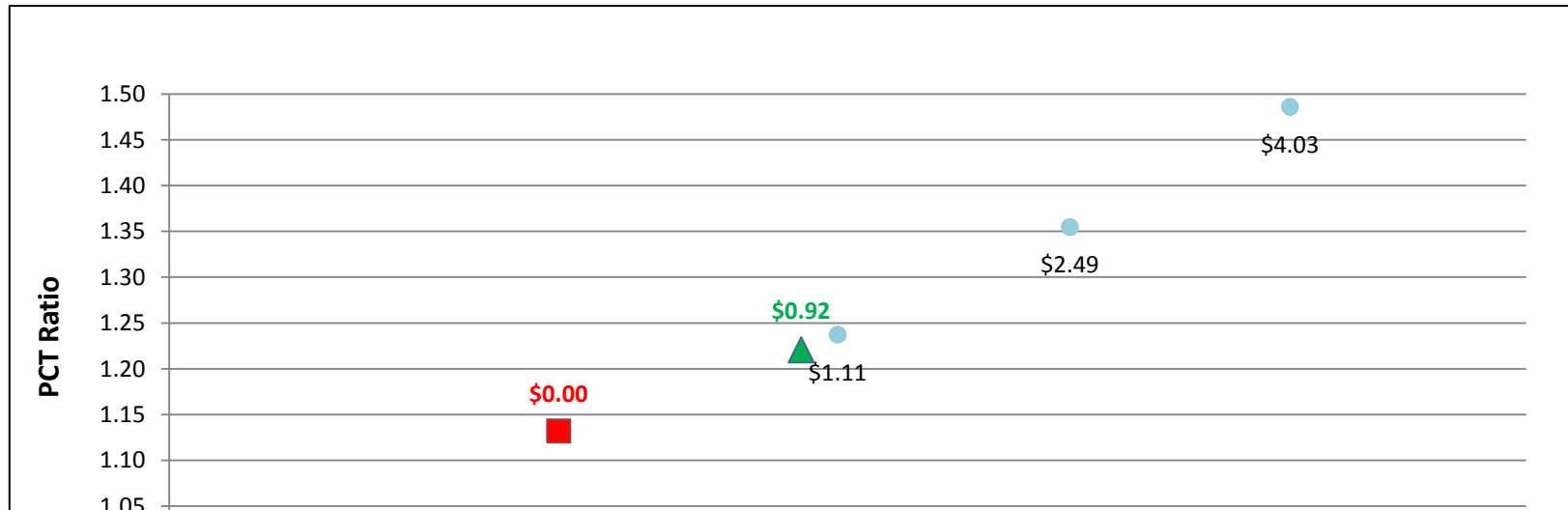


SGIP Cost Effectiveness Report
Participant Test Results (PCT)
MIRR Graphs

GTle3MW w/ On-Site BioGas - Commercial - SCE

	Rebate (\$/watt)	MIRR	PCT-2014
▲ Actual Rebate - 2014	\$0.92	12.8%	1.22
■ No Rebate	\$0.00	11.7%	1.13
● Rebate to Reach MIRR of 5%	\$0.00	0.0%	0.00
● Rebate to Reach MIRR of 6%	\$0.00	0.0%	0.00
● Rebate to Reach MIRR of 7%	\$0.00	0.0%	0.00
● Rebate to Reach MIRR of 8%	\$0.00	0.0%	0.00
● Rebate to Reach MIRR of 9%	\$0.00	0.0%	0.00
● Rebate to Reach MIRR of 10%	\$0.00	0.0%	0.00
● Rebate to Reach MIRR of 11%	\$0.00	0.0%	0.00
● Rebate to Reach MIRR of 12%	\$0.00	0.0%	0.00
● Rebate to Reach MIRR of 13%	\$1.11	13.0%	1.24
● Rebate to Reach MIRR of 14%	\$2.49	14.0%	1.35
● Rebate to Reach MIRR of 15%	\$4.03	15.0%	1.49

System Cost per Watt: \$4.43

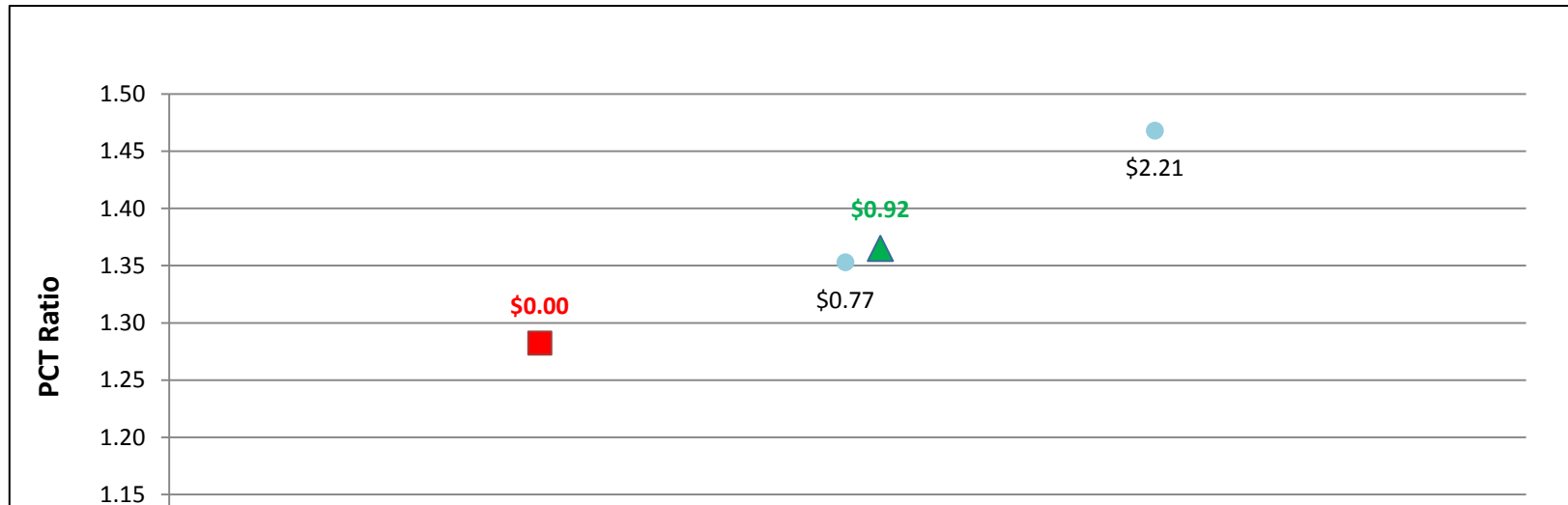


SGIP Cost Effectiveness Report
Participant Test Results (PCT)
MIRR Graphs

GTle3MW w/ On-Site BioGas - Commercial - SDG&E

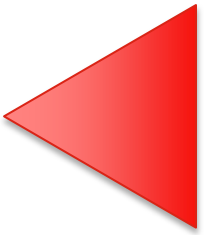
	Rebate (\$/watt)	MIRR	PCT-2014
▲ Actual Rebate - 2014	\$0.92	14.1%	1.37
■ No Rebate	\$0.00	13.1%	1.28
● Rebate to Reach MIRR of 5%	\$0.00	0.0%	0.00
● Rebate to Reach MIRR of 6%	\$0.00	0.0%	0.00
● Rebate to Reach MIRR of 7%	\$0.00	0.0%	0.00
● Rebate to Reach MIRR of 8%	\$0.00	0.0%	0.00
● Rebate to Reach MIRR of 9%	\$0.00	0.0%	0.00
● Rebate to Reach MIRR of 10%	\$0.00	0.0%	0.00
● Rebate to Reach MIRR of 11%	\$0.00	0.0%	0.00
● Rebate to Reach MIRR of 12%	\$0.00	0.0%	0.00
● Rebate to Reach MIRR of 13%	\$0.00	0.0%	0.00
● Rebate to Reach MIRR of 14%	\$0.77	14.0%	1.35
● Rebate to Reach MIRR of 15%	\$2.21	14.9%	1.47

System Cost per Watt: \$4.43





IC Engines

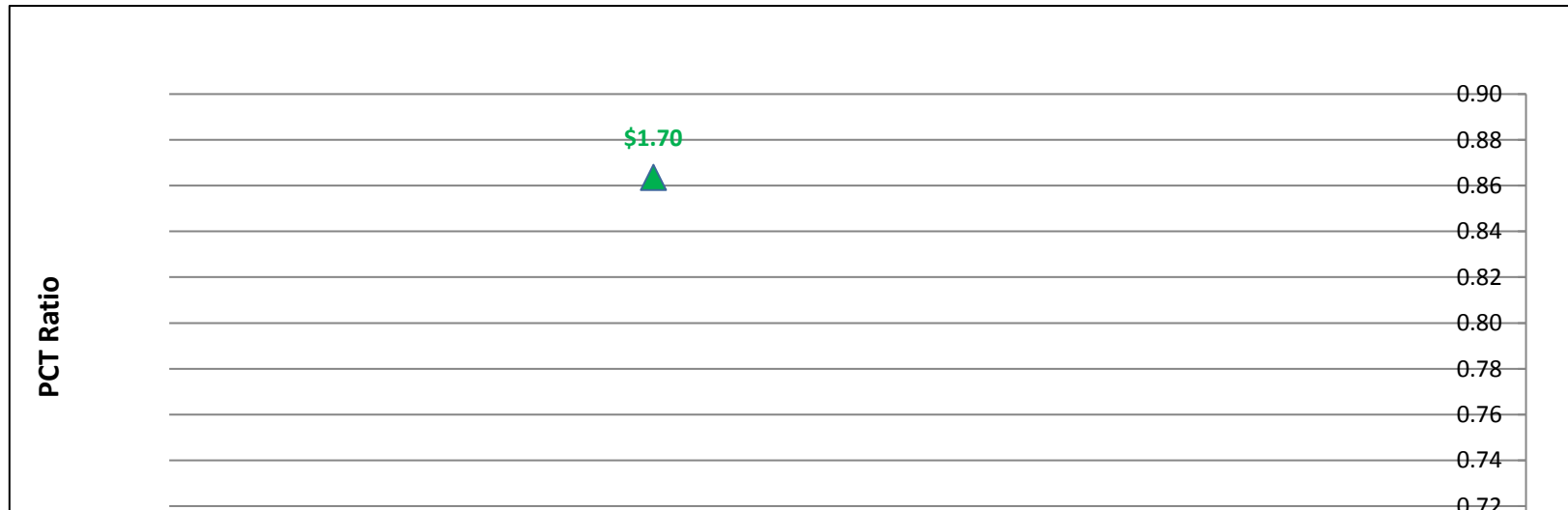


SGIP Cost Effectiveness Report
Participant Test Results (PCT)
MIRR Graphs

ICE1500kW w/ Directed BioGas - Government/Non-Profit - PG&E

	Rebate (\$/watt)	MIRR	PCT-2014
▲ Actual Rebate - 2014	\$1.70	-15.9%	0.86
■ No Rebate	\$0.00	-100.0%	0.80
● Rebate to Reach MIRR of 5%	\$0.00	0.0%	0.00
● Rebate to Reach MIRR of 6%	\$0.00	0.0%	0.00
● Rebate to Reach MIRR of 7%	\$0.00	0.0%	0.00
● Rebate to Reach MIRR of 8%	\$0.00	0.0%	0.00
● Rebate to Reach MIRR of 9%	\$0.00	0.0%	0.00
● Rebate to Reach MIRR of 10%	\$0.00	0.0%	0.00
● Rebate to Reach MIRR of 11%	\$0.00	0.0%	0.00
● Rebate to Reach MIRR of 12%	\$0.00	0.0%	0.00
● Rebate to Reach MIRR of 13%	\$0.00	0.0%	0.00
● Rebate to Reach MIRR of 14%	\$0.00	0.0%	0.00
● Rebate to Reach MIRR of 15%	\$0.00	0.0%	0.00

System Cost per Watt: \$2.05

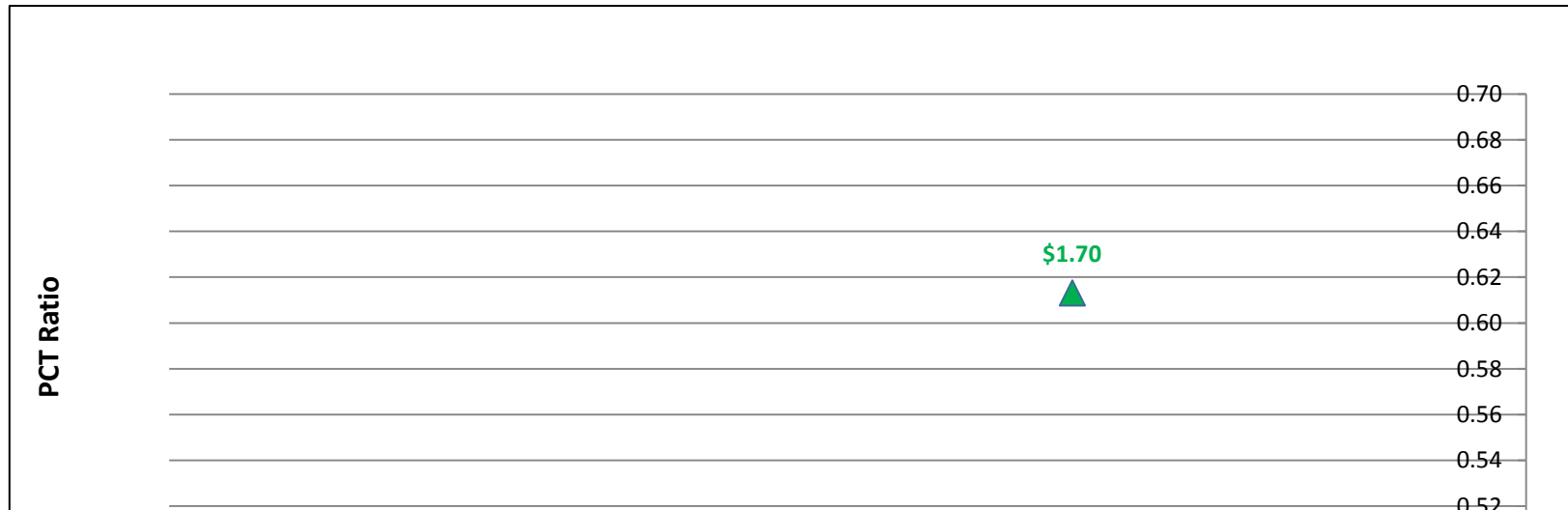


SGIP Cost Effectiveness Report
Participant Test Results (PCT)
MIRR Graphs

ICE1500kW w/ Directed BioGas - Government/Non-Profit - SCE

	Rebate (\$/watt)	MIRR	PCT-2014
▲ Actual Rebate - 2014	\$1.70	-20.0%	0.61
■ No Rebate	\$0.00	-100.0%	0.55
● Rebate to Reach MIRR of 5%	\$0.00	0.0%	0.00
● Rebate to Reach MIRR of 6%	\$0.00	0.0%	0.00
● Rebate to Reach MIRR of 7%	\$0.00	0.0%	0.00
● Rebate to Reach MIRR of 8%	\$0.00	0.0%	0.00
● Rebate to Reach MIRR of 9%	\$0.00	0.0%	0.00
● Rebate to Reach MIRR of 10%	\$0.00	0.0%	0.00
● Rebate to Reach MIRR of 11%	\$0.00	0.0%	0.00
● Rebate to Reach MIRR of 12%	\$0.00	0.0%	0.00
● Rebate to Reach MIRR of 13%	\$0.00	0.0%	0.00
● Rebate to Reach MIRR of 14%	\$0.00	0.0%	0.00
● Rebate to Reach MIRR of 15%	\$0.00	0.0%	0.00

System Cost per Watt: \$2.05

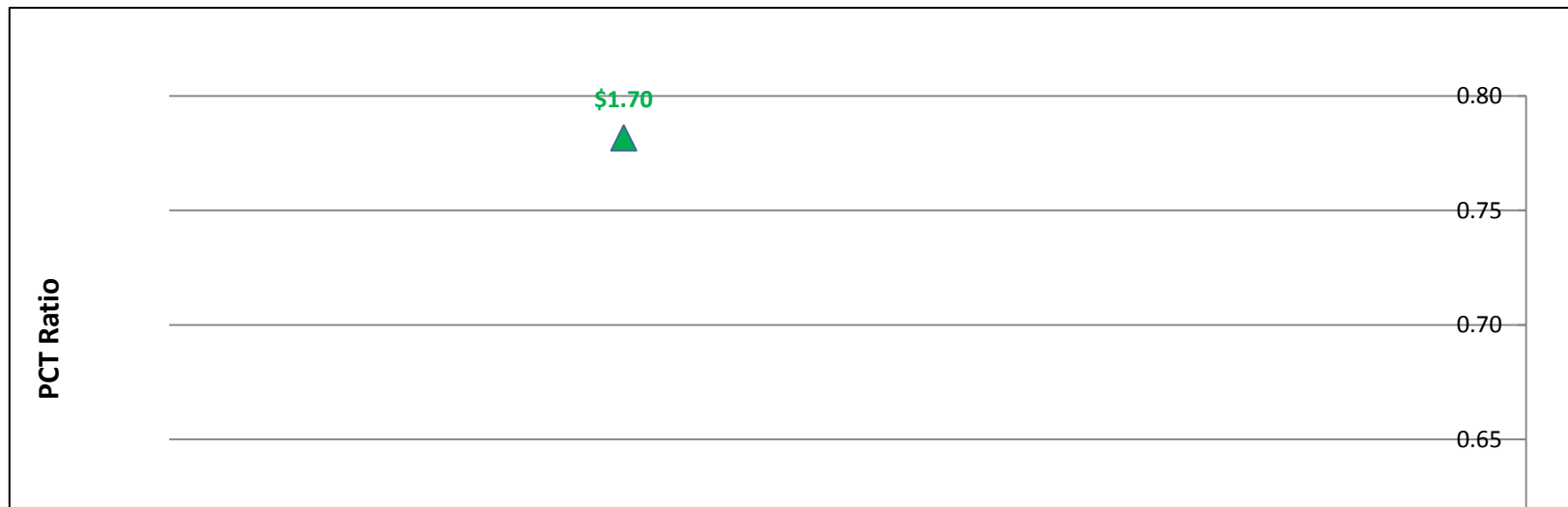


SGIP Cost Effectiveness Report
Participant Test Results (PCT)
MIRR Graphs

ICE1500kW w/ Directed BioGas - Government/Non-Profit - SDG&E

	Rebate (\$/watt)	MIRR	PCT-2014
▲ Actual Rebate - 2014	\$1.70	-18.0%	0.78
■ No Rebate	\$0.00	-100.0%	0.72
● Rebate to Reach MIRR of 5%	\$0.00	0.0%	0.00
● Rebate to Reach MIRR of 6%	\$0.00	0.0%	0.00
● Rebate to Reach MIRR of 7%	\$0.00	0.0%	0.00
● Rebate to Reach MIRR of 8%	\$0.00	0.0%	0.00
● Rebate to Reach MIRR of 9%	\$0.00	0.0%	0.00
● Rebate to Reach MIRR of 10%	\$0.00	0.0%	0.00
● Rebate to Reach MIRR of 11%	\$0.00	0.0%	0.00
● Rebate to Reach MIRR of 12%	\$0.00	0.0%	0.00
● Rebate to Reach MIRR of 13%	\$0.00	0.0%	0.00
● Rebate to Reach MIRR of 14%	\$0.00	0.0%	0.00
● Rebate to Reach MIRR of 15%	\$0.00	0.0%	0.00

System Cost per Watt: \$2.05



SGIP Cost Effectiveness Report
 Participant Test Results (PCT)
 MIRR Graphs

ICE1500kW w/ Natural Gas - Government/Non-Profit - PG&E

	Rebate (\$/watt)	MIRR	PCT-2014
▲ Actual Rebate - 2014	\$0.38	18.0%	1.52
■ No Rebate	\$0.00	16.3%	1.49
● Rebate to Reach MIRR of 5%	\$0.00	0.0%	0.00
● Rebate to Reach MIRR of 6%	\$0.00	0.0%	0.00
● Rebate to Reach MIRR of 7%	\$0.00	0.0%	0.00
● Rebate to Reach MIRR of 8%	\$0.00	0.0%	0.00
● Rebate to Reach MIRR of 9%	\$0.00	0.0%	0.00
● Rebate to Reach MIRR of 10%	\$0.00	0.0%	0.00
● Rebate to Reach MIRR of 11%	\$0.00	0.0%	0.00
● Rebate to Reach MIRR of 12%	\$0.00	0.0%	0.00
● Rebate to Reach MIRR of 13%	\$0.00	0.0%	0.00
● Rebate to Reach MIRR of 14%	\$0.00	0.0%	0.00
● Rebate to Reach MIRR of 15%	\$0.00	0.0%	0.00

System Cost per Watt: \$2.05

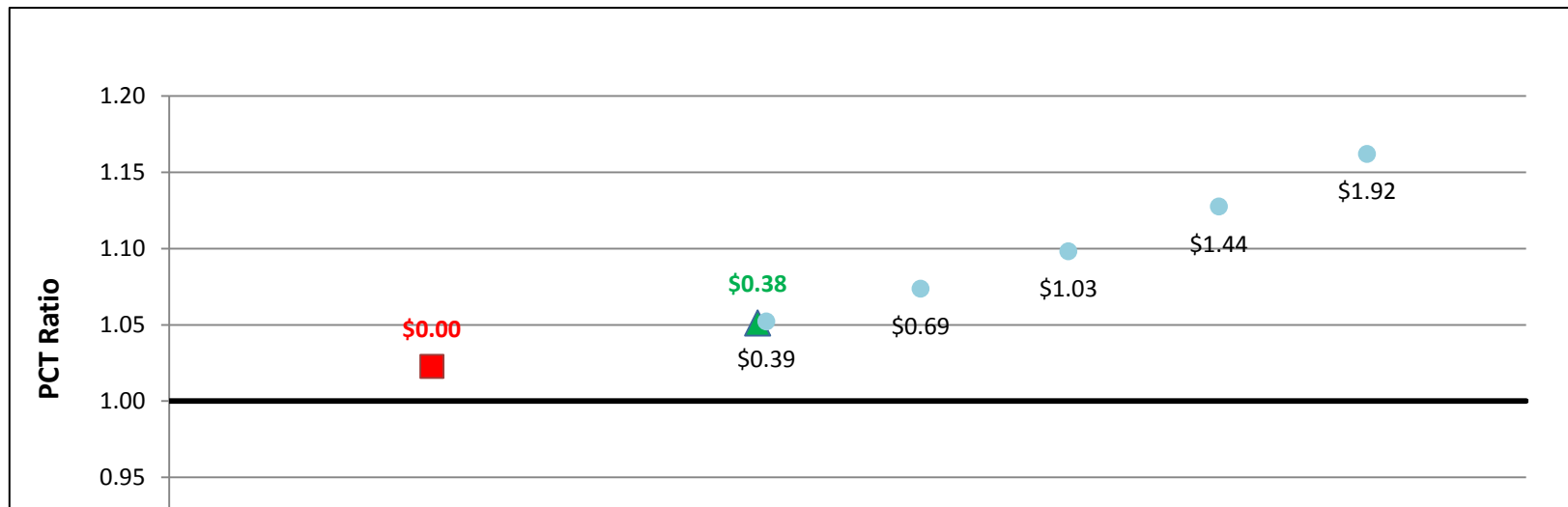


SGIP Cost Effectiveness Report
Participant Test Results (PCT)
MIRR Graphs

ICE1500kW w/ Natural Gas - Government/Non-Profit - SCE

	Rebate (\$/watt)	MIRR	PCT-2014
▲ Actual Rebate - 2014	\$0.38	7.9%	1.05
■ No Rebate	\$0.00	5.7%	1.02
● Rebate to Reach MIRR of 5%	\$0.00	0.0%	0.00
● Rebate to Reach MIRR of 6%	\$0.00	0.0%	0.00
● Rebate to Reach MIRR of 7%	\$0.00	0.0%	0.00
● Rebate to Reach MIRR of 8%	\$0.39	8.0%	1.05
● Rebate to Reach MIRR of 9%	\$0.69	9.0%	1.07
● Rebate to Reach MIRR of 10%	\$1.03	10.0%	1.10
● Rebate to Reach MIRR of 11%	\$1.44	11.0%	1.13
● Rebate to Reach MIRR of 12%	\$1.92	11.9%	1.16
● Rebate to Reach MIRR of 13%	\$0.00	0.0%	0.00
● Rebate to Reach MIRR of 14%	\$0.00	0.0%	0.00
● Rebate to Reach MIRR of 15%	\$0.00	0.0%	0.00

System Cost per Watt: \$2.05

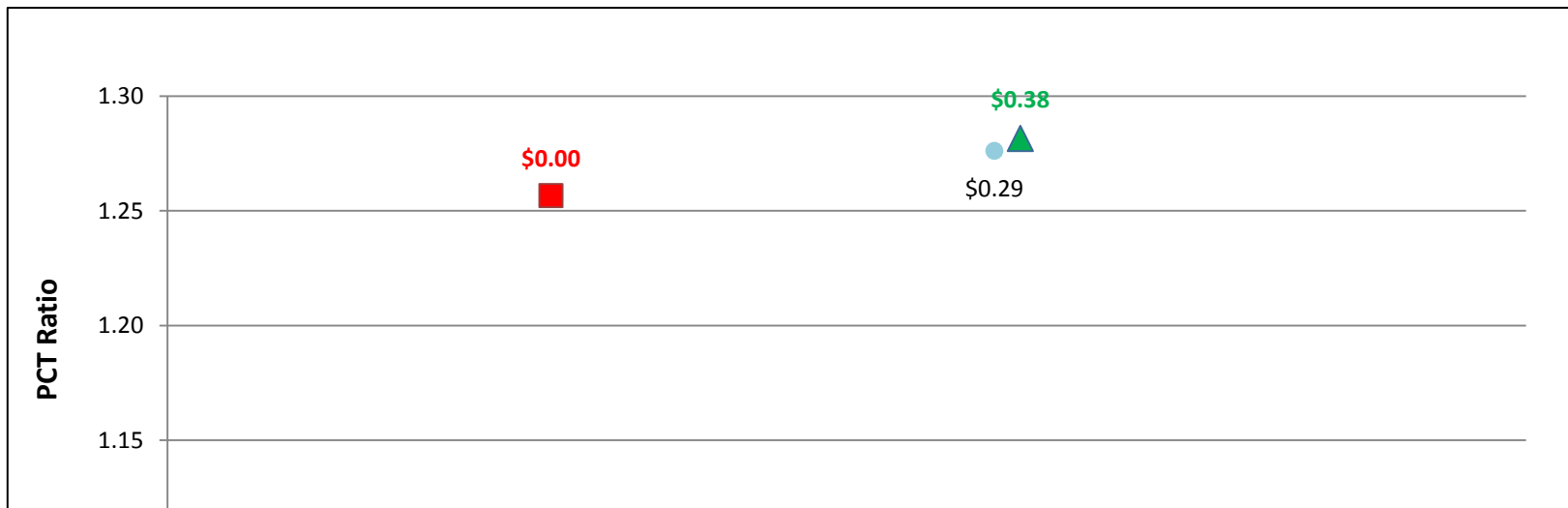


SGIP Cost Effectiveness Report
 Participant Test Results (PCT)
 MIRR Graphs

ICE1500kW w/ Natural Gas - Government/Non-Profit - SDG&E

	Rebate (\$/watt)	MIRR	PCT-2014
▲ Actual Rebate - 2014	\$0.38	15.1%	1.28
■ No Rebate	\$0.00	13.4%	1.26
● Rebate to Reach MIRR of 5%	\$0.00	0.0%	0.00
● Rebate to Reach MIRR of 6%	\$0.00	0.0%	0.00
● Rebate to Reach MIRR of 7%	\$0.00	0.0%	0.00
● Rebate to Reach MIRR of 8%	\$0.00	0.0%	0.00
● Rebate to Reach MIRR of 9%	\$0.00	0.0%	0.00
● Rebate to Reach MIRR of 10%	\$0.00	0.0%	0.00
● Rebate to Reach MIRR of 11%	\$0.00	0.0%	0.00
● Rebate to Reach MIRR of 12%	\$0.00	0.0%	0.00
● Rebate to Reach MIRR of 13%	\$0.00	0.0%	0.00
● Rebate to Reach MIRR of 14%	\$0.00	0.0%	0.00
● Rebate to Reach MIRR of 15%	\$0.29	15.0%	1.28

System Cost per Watt: \$2.05

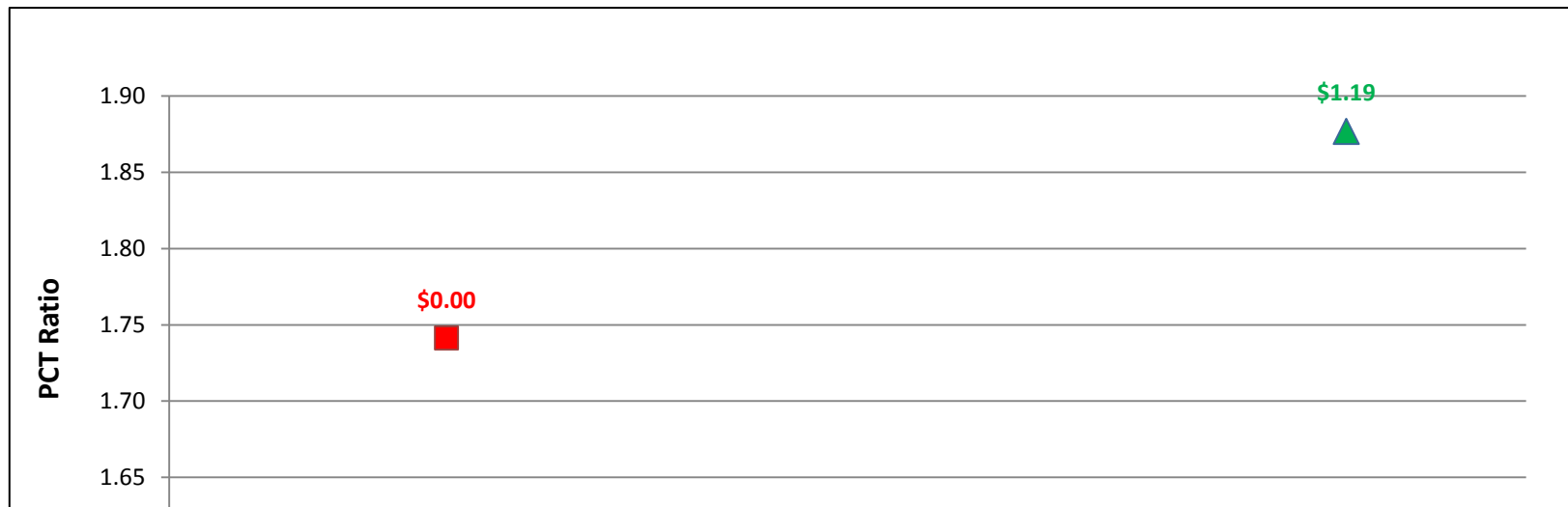


SGIP Cost Effectiveness Report
Participant Test Results (PCT)
MIRR Graphs

ICE1500kW w/ On-Site BioGas - Government/Non-Profit - PG&E

	Rebate (\$/watt)	MIRR	PCT-2014
▲ Actual Rebate - 2014	\$1.19	19.9%	1.88
■ No Rebate	\$0.00	14.6%	1.74
● Rebate to Reach MIRR of 5%	\$0.00	0.0%	0.00
● Rebate to Reach MIRR of 6%	\$0.00	0.0%	0.00
● Rebate to Reach MIRR of 7%	\$0.00	0.0%	0.00
● Rebate to Reach MIRR of 8%	\$0.00	0.0%	0.00
● Rebate to Reach MIRR of 9%	\$0.00	0.0%	0.00
● Rebate to Reach MIRR of 10%	\$0.00	0.0%	0.00
● Rebate to Reach MIRR of 11%	\$0.00	0.0%	0.00
● Rebate to Reach MIRR of 12%	\$0.00	0.0%	0.00
● Rebate to Reach MIRR of 13%	\$0.00	0.0%	0.00
● Rebate to Reach MIRR of 14%	\$0.00	0.0%	0.00
● Rebate to Reach MIRR of 15%	\$0.00	0.0%	0.00

System Cost per Watt: \$2.68

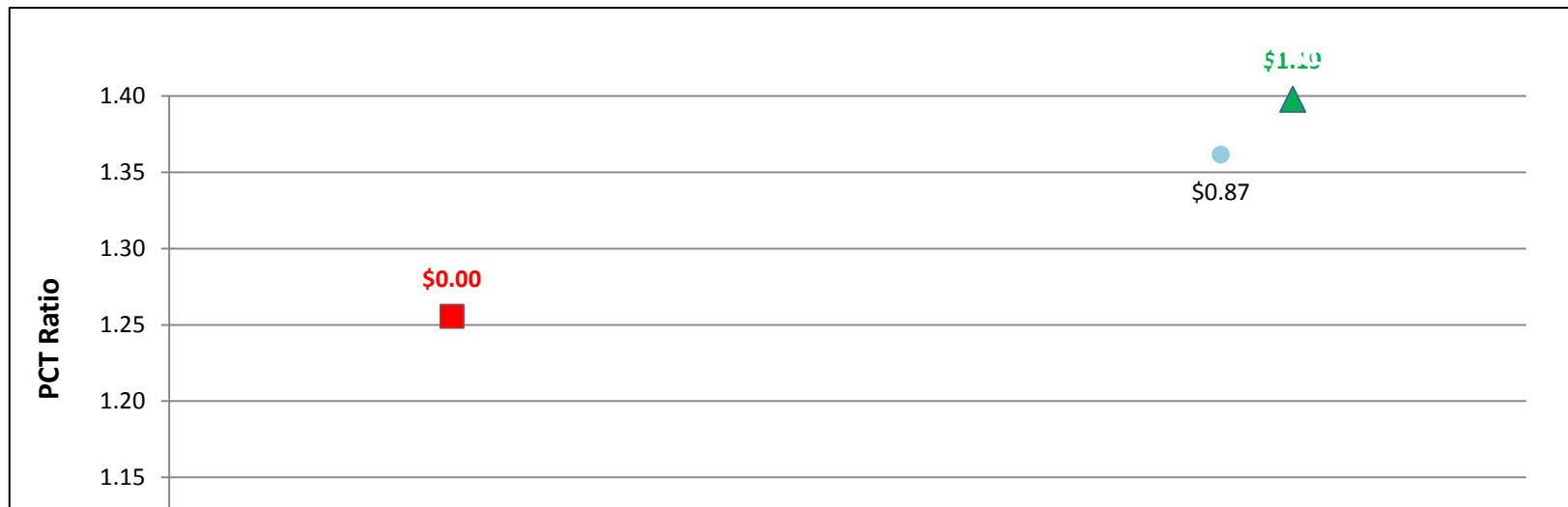


SGIP Cost Effectiveness Report
Participant Test Results (PCT)
MIRR Graphs

ICE1500kW w/ On-Site BioGas - Government/Non-Profit - SCE

	Rebate (\$/watt)	MIRR	PCT-2014
▲ Actual Rebate - 2014	\$1.19	15.5%	1.40
■ No Rebate	\$0.00	9.9%	1.26
● Rebate to Reach MIRR of 5%	\$0.00	0.0%	0.00
● Rebate to Reach MIRR of 6%	\$0.00	0.0%	0.00
● Rebate to Reach MIRR of 7%	\$0.00	0.0%	0.00
● Rebate to Reach MIRR of 8%	\$0.00	0.0%	0.00
● Rebate to Reach MIRR of 9%	\$0.00	0.0%	0.00
● Rebate to Reach MIRR of 10%	\$0.00	0.0%	0.00
● Rebate to Reach MIRR of 11%	\$0.00	0.0%	0.00
● Rebate to Reach MIRR of 12%	\$0.00	0.0%	0.00
● Rebate to Reach MIRR of 13%	\$0.00	0.0%	0.00
● Rebate to Reach MIRR of 14%	\$0.00	0.0%	0.00
● Rebate to Reach MIRR of 15%	\$0.87	15.0%	1.36

System Cost per Watt: \$2.68

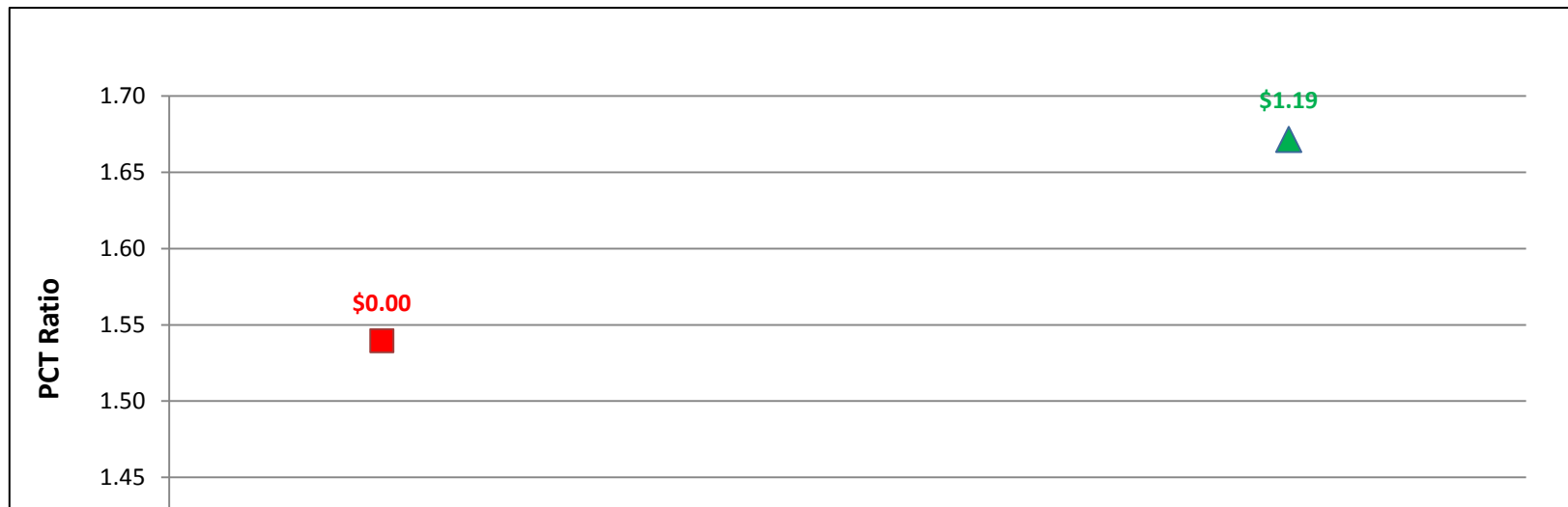


SGIP Cost Effectiveness Report
Participant Test Results (PCT)
MIRR Graphs

ICE1500kW w/ On-Site BioGas - Government/Non-Profit - SDG&E

	Rebate (\$/watt)	MIRR	PCT-2014
▲ Actual Rebate - 2014	\$1.19	18.6%	1.67
■ No Rebate	\$0.00	13.3%	1.54
● Rebate to Reach MIRR of 5%	\$0.00	0.0%	0.00
● Rebate to Reach MIRR of 6%	\$0.00	0.0%	0.00
● Rebate to Reach MIRR of 7%	\$0.00	0.0%	0.00
● Rebate to Reach MIRR of 8%	\$0.00	0.0%	0.00
● Rebate to Reach MIRR of 9%	\$0.00	0.0%	0.00
● Rebate to Reach MIRR of 10%	\$0.00	0.0%	0.00
● Rebate to Reach MIRR of 11%	\$0.00	0.0%	0.00
● Rebate to Reach MIRR of 12%	\$0.00	0.0%	0.00
● Rebate to Reach MIRR of 13%	\$0.00	0.0%	0.00
● Rebate to Reach MIRR of 14%	\$0.00	0.0%	0.00
● Rebate to Reach MIRR of 15%	\$0.00	0.0%	0.00

System Cost per Watt: \$2.68

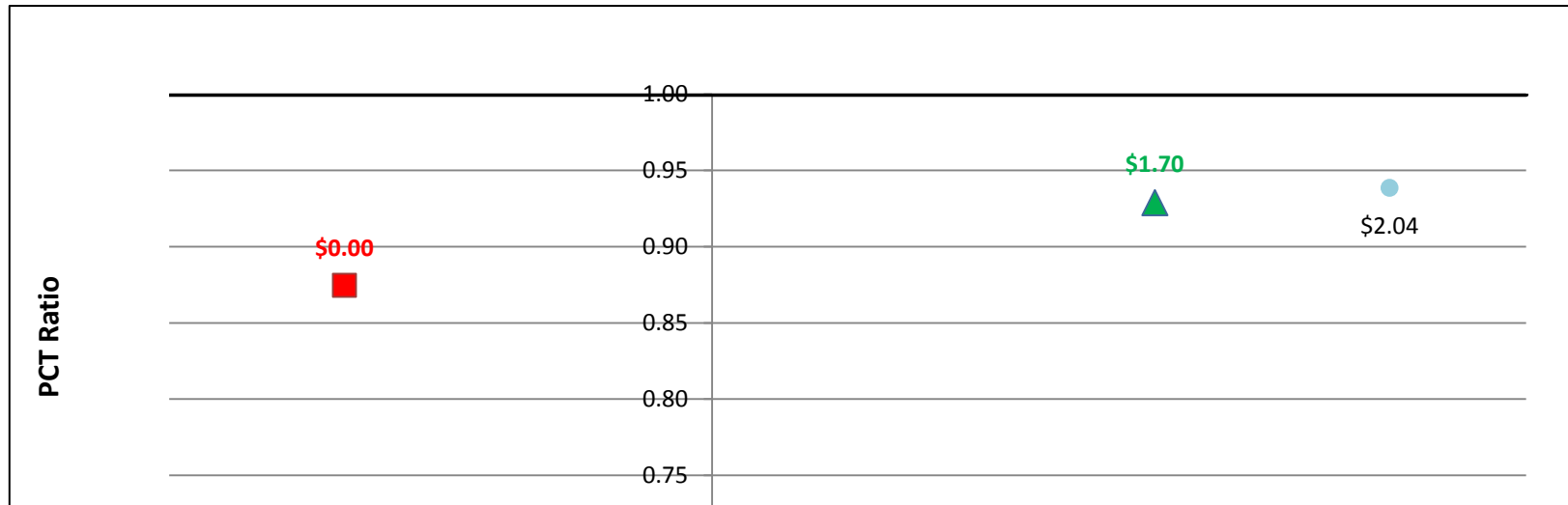


SGIP Cost Effectiveness Report
 Participant Test Results (PCT)
 MIRR Graphs

ICE1500kW w/ Directed BioGas - Commercial - PG&E

	Rebate (\$/watt)	MIRR	PCT-2014
▲ Actual Rebate - 2014	\$1.70	3.3%	0.93
■ No Rebate	\$0.00	-2.7%	0.87
● Rebate to Reach MIRR of 5%	\$2.04	5.0%	0.94
● Rebate to Reach MIRR of 6%	\$0.00	0.0%	0.00
● Rebate to Reach MIRR of 7%	\$0.00	0.0%	0.00
● Rebate to Reach MIRR of 8%	\$0.00	0.0%	0.00
● Rebate to Reach MIRR of 9%	\$0.00	0.0%	0.00
● Rebate to Reach MIRR of 10%	\$0.00	0.0%	0.00
● Rebate to Reach MIRR of 11%	\$0.00	0.0%	0.00
● Rebate to Reach MIRR of 12%	\$0.00	0.0%	0.00
● Rebate to Reach MIRR of 13%	\$0.00	0.0%	0.00
● Rebate to Reach MIRR of 14%	\$0.00	0.0%	0.00
● Rebate to Reach MIRR of 15%	\$0.00	0.0%	0.00

System Cost per Watt: \$2.05



SGIP Cost Effectiveness Report
Participant Test Results (PCT)
MIRR Graphs

ICE1500kW w/ Directed BioGas - Commercial - SCE

	Rebate (\$/watt)	MIRR	PCT-2014
▲ Actual Rebate - 2014	\$1.70	-13.0%	0.79
■ No Rebate	\$0.00	-100.0%	0.73
● Rebate to Reach MIRR of 5%	\$0.00	0.0%	0.00
● Rebate to Reach MIRR of 6%	\$0.00	0.0%	0.00
● Rebate to Reach MIRR of 7%	\$0.00	0.0%	0.00
● Rebate to Reach MIRR of 8%	\$0.00	0.0%	0.00
● Rebate to Reach MIRR of 9%	\$0.00	0.0%	0.00
● Rebate to Reach MIRR of 10%	\$0.00	0.0%	0.00
● Rebate to Reach MIRR of 11%	\$0.00	0.0%	0.00
● Rebate to Reach MIRR of 12%	\$0.00	0.0%	0.00
● Rebate to Reach MIRR of 13%	\$0.00	0.0%	0.00
● Rebate to Reach MIRR of 14%	\$0.00	0.0%	0.00
● Rebate to Reach MIRR of 15%	\$0.00	0.0%	0.00

System Cost per Watt: \$2.05

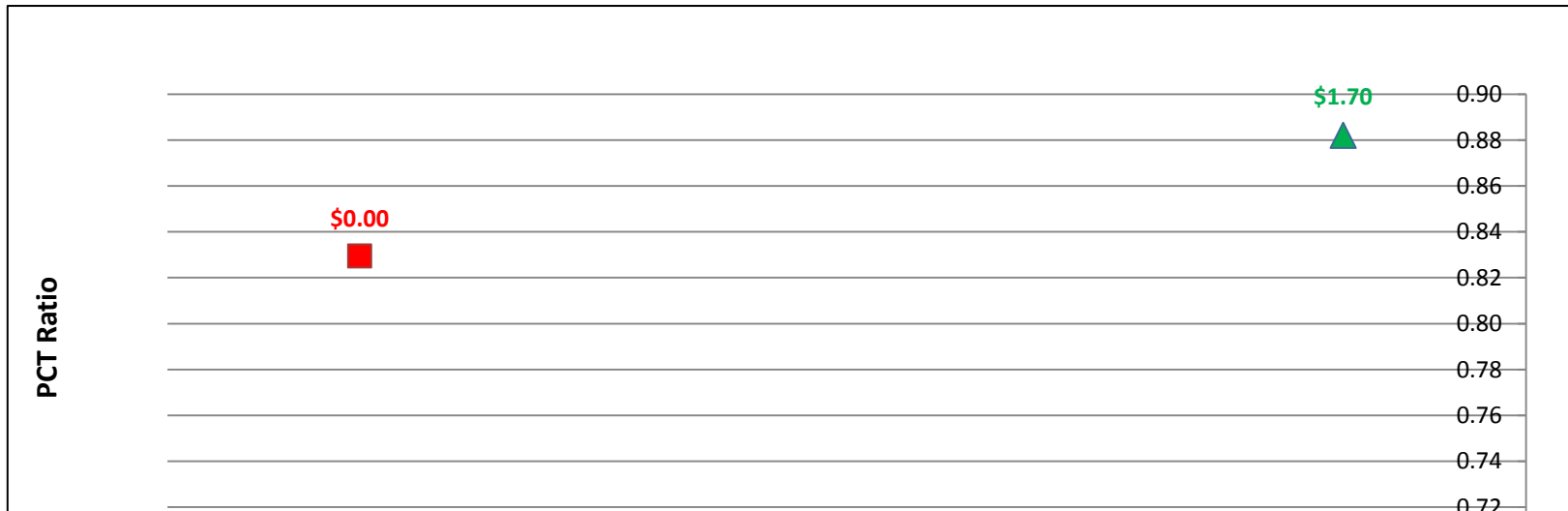


SGIP Cost Effectiveness Report
Participant Test Results (PCT)
MIRR Graphs

ICE1500kW w/ Directed BioGas - Commercial - SDG&E

	Rebate (\$/watt)	MIRR	PCT-2014
▲ Actual Rebate - 2014	\$1.70	-1.3%	0.88
■ No Rebate	\$0.00	-8.6%	0.83
● Rebate to Reach MIRR of 5%	\$0.00	0.0%	0.00
● Rebate to Reach MIRR of 6%	\$0.00	0.0%	0.00
● Rebate to Reach MIRR of 7%	\$0.00	0.0%	0.00
● Rebate to Reach MIRR of 8%	\$0.00	0.0%	0.00
● Rebate to Reach MIRR of 9%	\$0.00	0.0%	0.00
● Rebate to Reach MIRR of 10%	\$0.00	0.0%	0.00
● Rebate to Reach MIRR of 11%	\$0.00	0.0%	0.00
● Rebate to Reach MIRR of 12%	\$0.00	0.0%	0.00
● Rebate to Reach MIRR of 13%	\$0.00	0.0%	0.00
● Rebate to Reach MIRR of 14%	\$0.00	0.0%	0.00
● Rebate to Reach MIRR of 15%	\$0.00	0.0%	0.00

System Cost per Watt: \$2.05

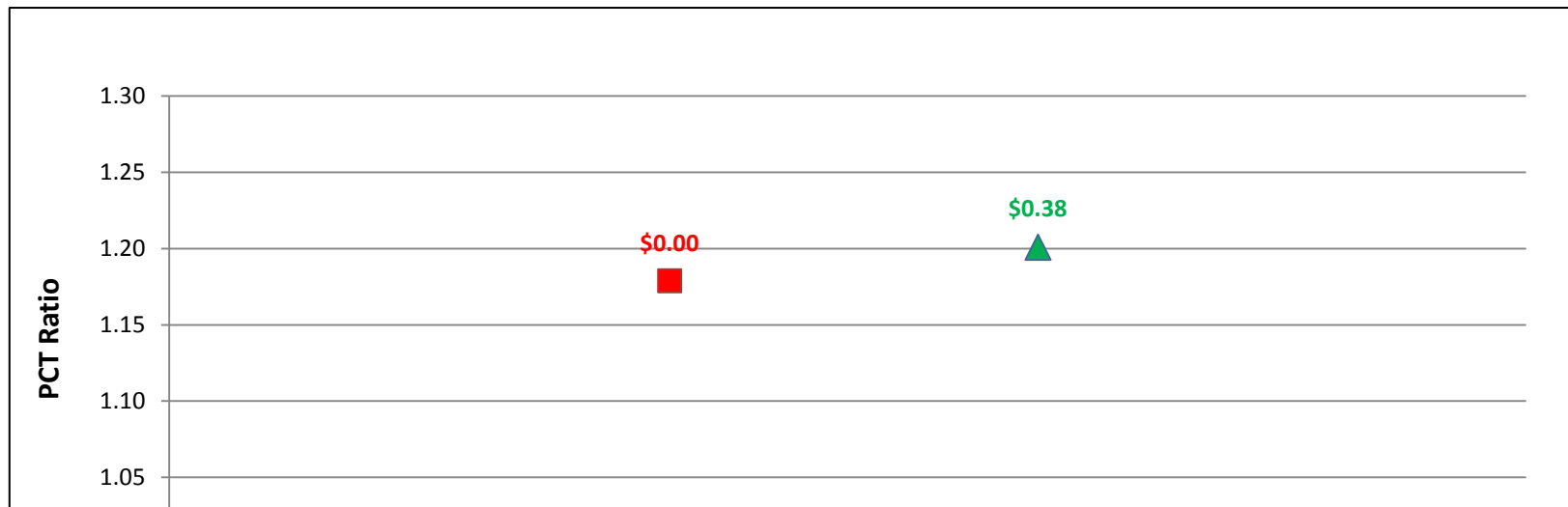


SGIP Cost Effectiveness Report
Participant Test Results (PCT)
MIRR Graphs

ICE1500kW w/ Natural Gas - Commercial - PG&E

	Rebate (\$/watt)	MIRR	PCT-2014
▲ Actual Rebate - 2014	\$0.38	15.9%	1.20
■ No Rebate	\$0.00	15.1%	1.18
● Rebate to Reach MIRR of 5%	\$0.00	0.0%	0.00
● Rebate to Reach MIRR of 6%	\$0.00	0.0%	0.00
● Rebate to Reach MIRR of 7%	\$0.00	0.0%	0.00
● Rebate to Reach MIRR of 8%	\$0.00	0.0%	0.00
● Rebate to Reach MIRR of 9%	\$0.00	0.0%	0.00
● Rebate to Reach MIRR of 10%	\$0.00	0.0%	0.00
● Rebate to Reach MIRR of 11%	\$0.00	0.0%	0.00
● Rebate to Reach MIRR of 12%	\$0.00	0.0%	0.00
● Rebate to Reach MIRR of 13%	\$0.00	0.0%	0.00
● Rebate to Reach MIRR of 14%	\$0.00	0.0%	0.00
● Rebate to Reach MIRR of 15%	\$0.00	0.0%	0.00

System Cost per Watt: \$2.05

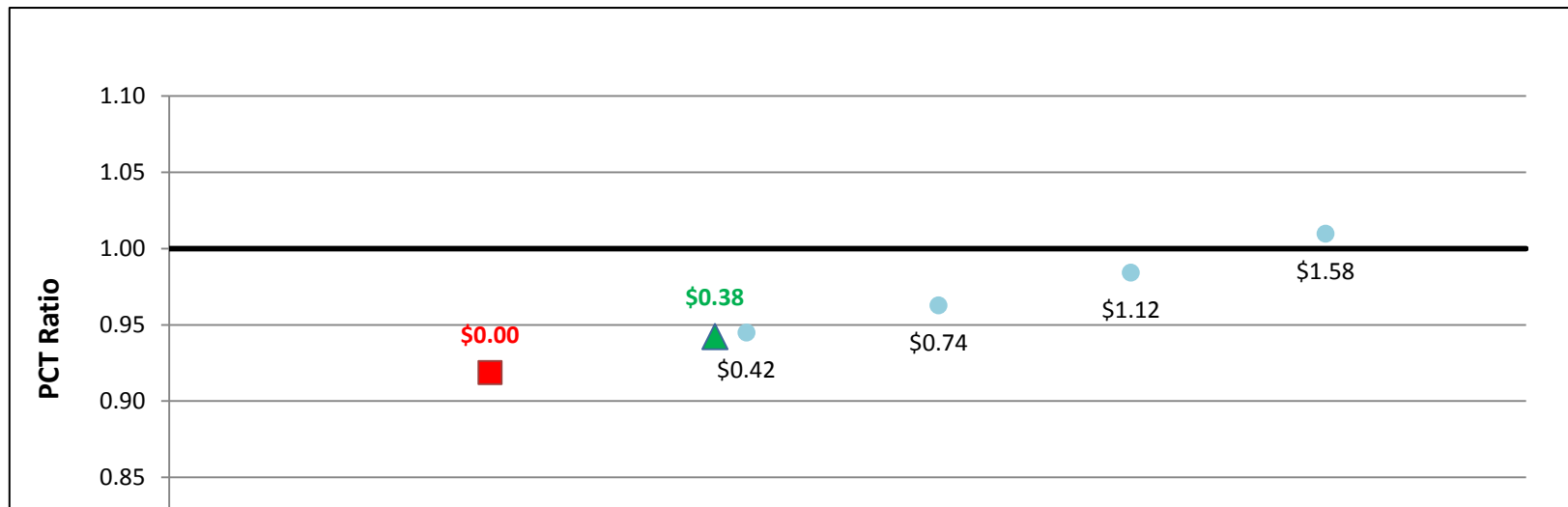


SGIP Cost Effectiveness Report
Participant Test Results (PCT)
MIRR Graphs

ICE1500kW w/ Natural Gas - Commercial - SCE

	Rebate (\$/watt)	MIRR	PCT-2014
▲ Actual Rebate - 2014	\$0.38	7.8%	0.94
■ No Rebate	\$0.00	6.7%	0.92
● Rebate to Reach MIRR of 5%	\$0.00	0.0%	0.00
● Rebate to Reach MIRR of 6%	\$0.00	0.0%	0.00
● Rebate to Reach MIRR of 7%	\$0.00	0.0%	0.00
● Rebate to Reach MIRR of 8%	\$0.42	8.0%	0.94
● Rebate to Reach MIRR of 9%	\$0.74	9.0%	0.96
● Rebate to Reach MIRR of 10%	\$1.12	10.0%	0.98
● Rebate to Reach MIRR of 11%	\$1.58	11.0%	1.01
● Rebate to Reach MIRR of 12%	\$0.00	0.0%	0.00
● Rebate to Reach MIRR of 13%	\$0.00	0.0%	0.00
● Rebate to Reach MIRR of 14%	\$0.00	0.0%	0.00
● Rebate to Reach MIRR of 15%	\$0.00	0.0%	0.00

System Cost per Watt: \$2.05

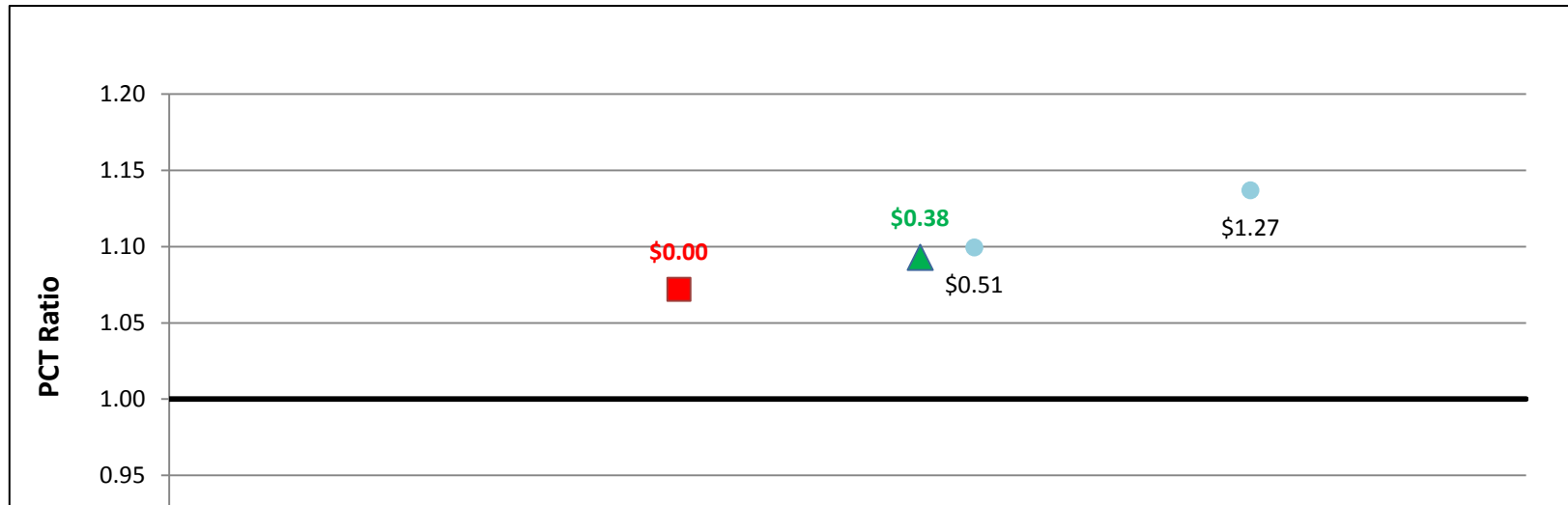


SGIP Cost Effectiveness Report
Participant Test Results (PCT)
MIRR Graphs

ICE1500kW w/ Natural Gas - Commercial - SDG&E

	Rebate (\$/watt)	MIRR	PCT-2014
▲ Actual Rebate - 2014	\$0.38	13.8%	1.09
■ No Rebate	\$0.00	12.9%	1.07
● Rebate to Reach MIRR of 5%	\$0.00	0.0%	0.00
● Rebate to Reach MIRR of 6%	\$0.00	0.0%	0.00
● Rebate to Reach MIRR of 7%	\$0.00	0.0%	0.00
● Rebate to Reach MIRR of 8%	\$0.00	0.0%	0.00
● Rebate to Reach MIRR of 9%	\$0.00	0.0%	0.00
● Rebate to Reach MIRR of 10%	\$0.00	0.0%	0.00
● Rebate to Reach MIRR of 11%	\$0.00	0.0%	0.00
● Rebate to Reach MIRR of 12%	\$0.00	0.0%	0.00
● Rebate to Reach MIRR of 13%	\$0.00	0.0%	0.00
● Rebate to Reach MIRR of 14%	\$0.51	14.0%	1.10
● Rebate to Reach MIRR of 15%	\$1.27	15.0%	1.14

System Cost per Watt: \$2.05

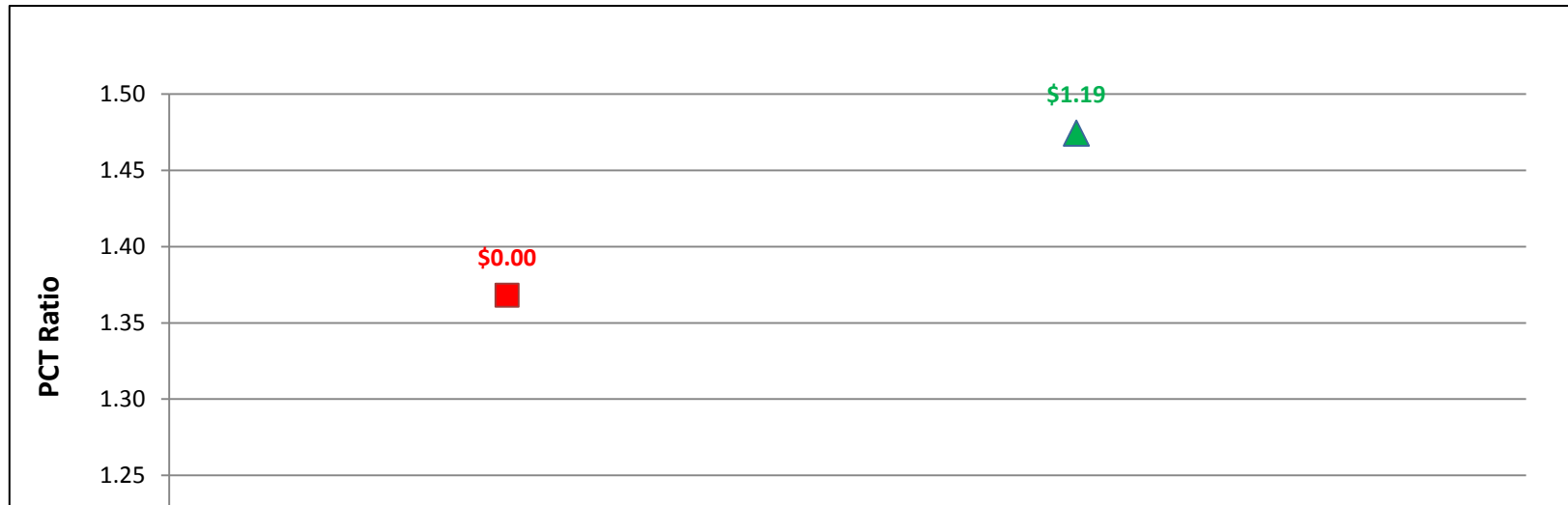


SGIP Cost Effectiveness Report
Participant Test Results (PCT)
MIRR Graphs

ICE1500kW w/ On-Site BioGas - Commercial - PG&E

	Rebate (\$/watt)	MIRR	PCT-2014
▲ Actual Rebate - 2014	\$1.19	17.3%	1.47
■ No Rebate	\$0.00	15.2%	1.37
● Rebate to Reach MIRR of 5%	\$0.00	0.0%	0.00
● Rebate to Reach MIRR of 6%	\$0.00	0.0%	0.00
● Rebate to Reach MIRR of 7%	\$0.00	0.0%	0.00
● Rebate to Reach MIRR of 8%	\$0.00	0.0%	0.00
● Rebate to Reach MIRR of 9%	\$0.00	0.0%	0.00
● Rebate to Reach MIRR of 10%	\$0.00	0.0%	0.00
● Rebate to Reach MIRR of 11%	\$0.00	0.0%	0.00
● Rebate to Reach MIRR of 12%	\$0.00	0.0%	0.00
● Rebate to Reach MIRR of 13%	\$0.00	0.0%	0.00
● Rebate to Reach MIRR of 14%	\$0.00	0.0%	0.00
● Rebate to Reach MIRR of 15%	\$0.00	0.0%	0.00

System Cost per Watt: \$2.68

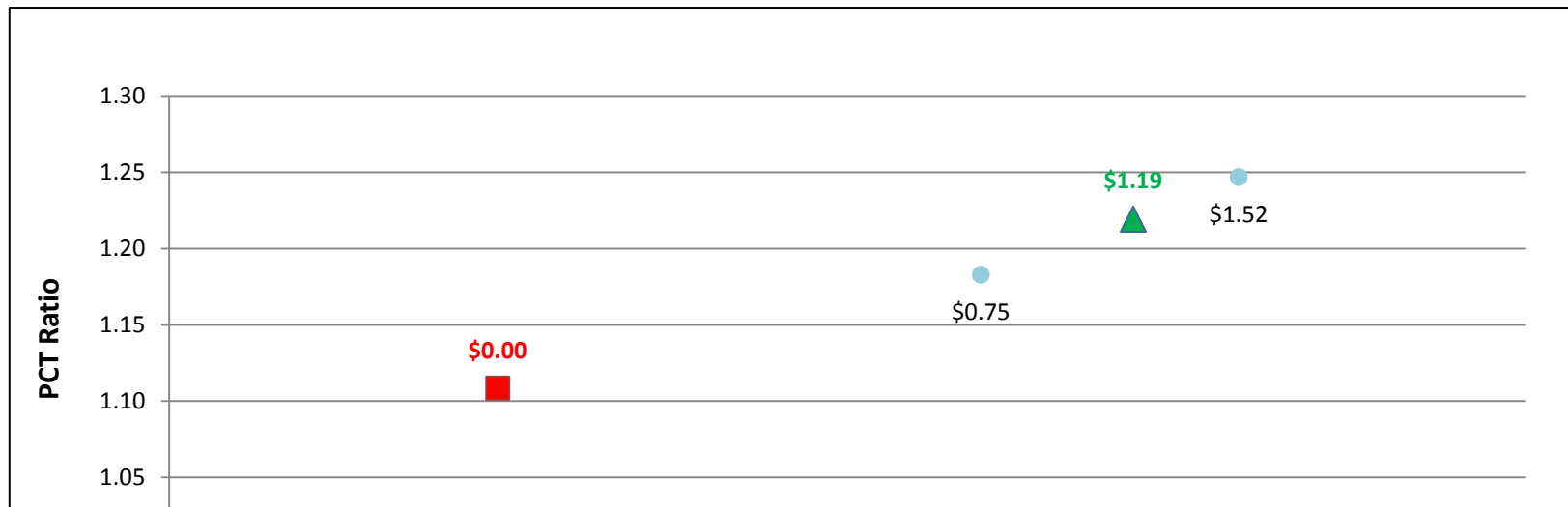


SGIP Cost Effectiveness Report
Participant Test Results (PCT)
MIRR Graphs

ICE1500kW w/ On-Site BioGas - Commercial - SCE

	Rebate (\$/watt)	MIRR	PCT-2014
▲ Actual Rebate - 2014	\$1.19	14.6%	1.22
■ No Rebate	\$0.00	12.2%	1.11
● Rebate to Reach MIRR of 5%	\$0.00	0.0%	0.00
● Rebate to Reach MIRR of 6%	\$0.00	0.0%	0.00
● Rebate to Reach MIRR of 7%	\$0.00	0.0%	0.00
● Rebate to Reach MIRR of 8%	\$0.00	0.0%	0.00
● Rebate to Reach MIRR of 9%	\$0.00	0.0%	0.00
● Rebate to Reach MIRR of 10%	\$0.00	0.0%	0.00
● Rebate to Reach MIRR of 11%	\$0.00	0.0%	0.00
● Rebate to Reach MIRR of 12%	\$0.00	0.0%	0.00
● Rebate to Reach MIRR of 13%	\$0.00	0.0%	0.00
● Rebate to Reach MIRR of 14%	\$0.75	14.0%	1.18
● Rebate to Reach MIRR of 15%	\$1.52	14.9%	1.25

System Cost per Watt: \$2.68

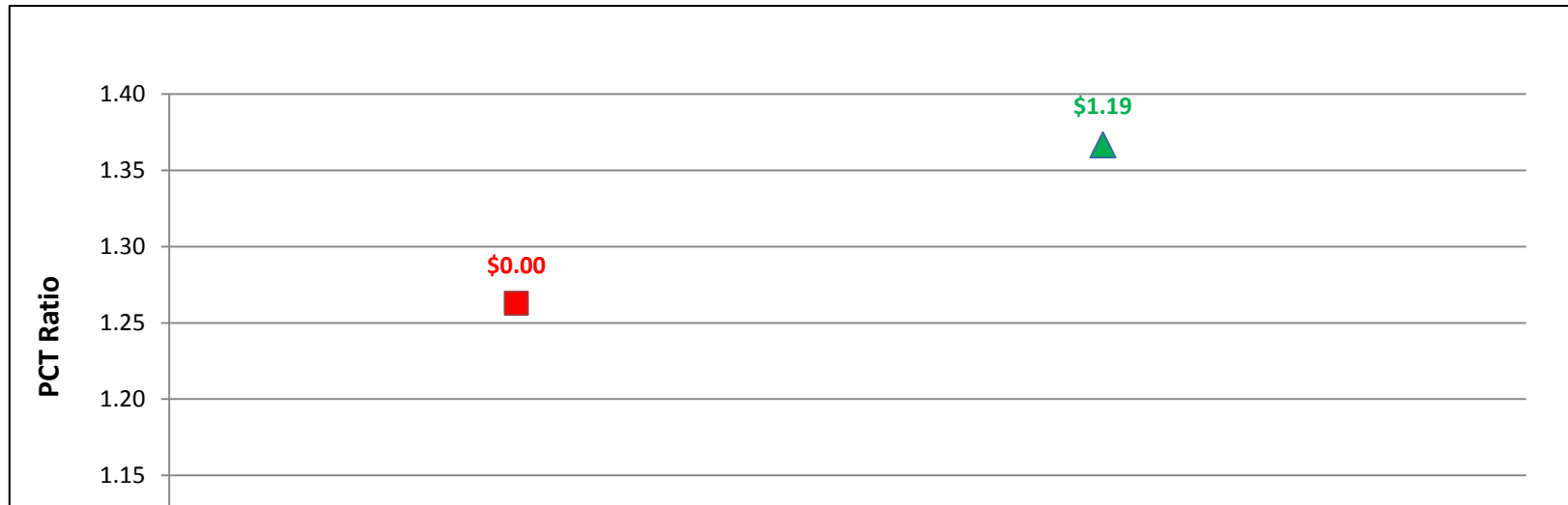


SGIP Cost Effectiveness Report
Participant Test Results (PCT)
MIRR Graphs

ICE1500kW w/ On-Site BioGas - Commercial - SDG&E

	Rebate (\$/watt)	MIRR	PCT-2014
▲ Actual Rebate - 2014	\$1.19	16.4%	1.37
■ No Rebate	\$0.00	14.3%	1.26
● Rebate to Reach MIRR of 5%	\$0.00	0.0%	0.00
● Rebate to Reach MIRR of 6%	\$0.00	0.0%	0.00
● Rebate to Reach MIRR of 7%	\$0.00	0.0%	0.00
● Rebate to Reach MIRR of 8%	\$0.00	0.0%	0.00
● Rebate to Reach MIRR of 9%	\$0.00	0.0%	0.00
● Rebate to Reach MIRR of 10%	\$0.00	0.0%	0.00
● Rebate to Reach MIRR of 11%	\$0.00	0.0%	0.00
● Rebate to Reach MIRR of 12%	\$0.00	0.0%	0.00
● Rebate to Reach MIRR of 13%	\$0.00	0.0%	0.00
● Rebate to Reach MIRR of 14%	\$0.00	0.0%	0.00
● Rebate to Reach MIRR of 15%	\$0.00	0.0%	0.00

System Cost per Watt: \$2.68

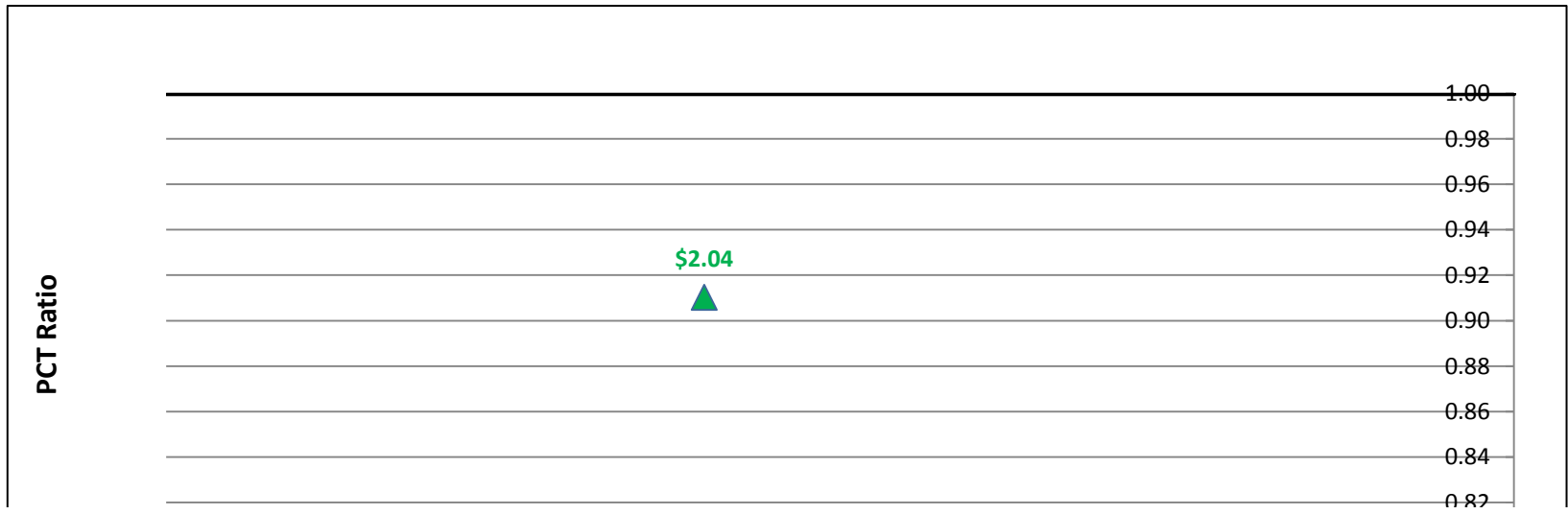


SGIP Cost Effectiveness Report
Participant Test Results (PCT)
MIRR Graphs

ICE500kW w/ Directed BioGas - Government/Non-Profit - PG&E

	Rebate (\$/watt)	MIRR	PCT-2014
▲ Actual Rebate - 2014	\$2.04	-22.8%	0.91
■ No Rebate	\$0.00	-100.0%	0.83
● Rebate to Reach MIRR of 5%	\$0.00	0.0%	0.00
● Rebate to Reach MIRR of 6%	\$0.00	0.0%	0.00
● Rebate to Reach MIRR of 7%	\$0.00	0.0%	0.00
● Rebate to Reach MIRR of 8%	\$0.00	0.0%	0.00
● Rebate to Reach MIRR of 9%	\$0.00	0.0%	0.00
● Rebate to Reach MIRR of 10%	\$0.00	0.0%	0.00
● Rebate to Reach MIRR of 11%	\$0.00	0.0%	0.00
● Rebate to Reach MIRR of 12%	\$0.00	0.0%	0.00
● Rebate to Reach MIRR of 13%	\$0.00	0.0%	0.00
● Rebate to Reach MIRR of 14%	\$0.00	0.0%	0.00
● Rebate to Reach MIRR of 15%	\$0.00	0.0%	0.00

System Cost per Watt: \$2.59

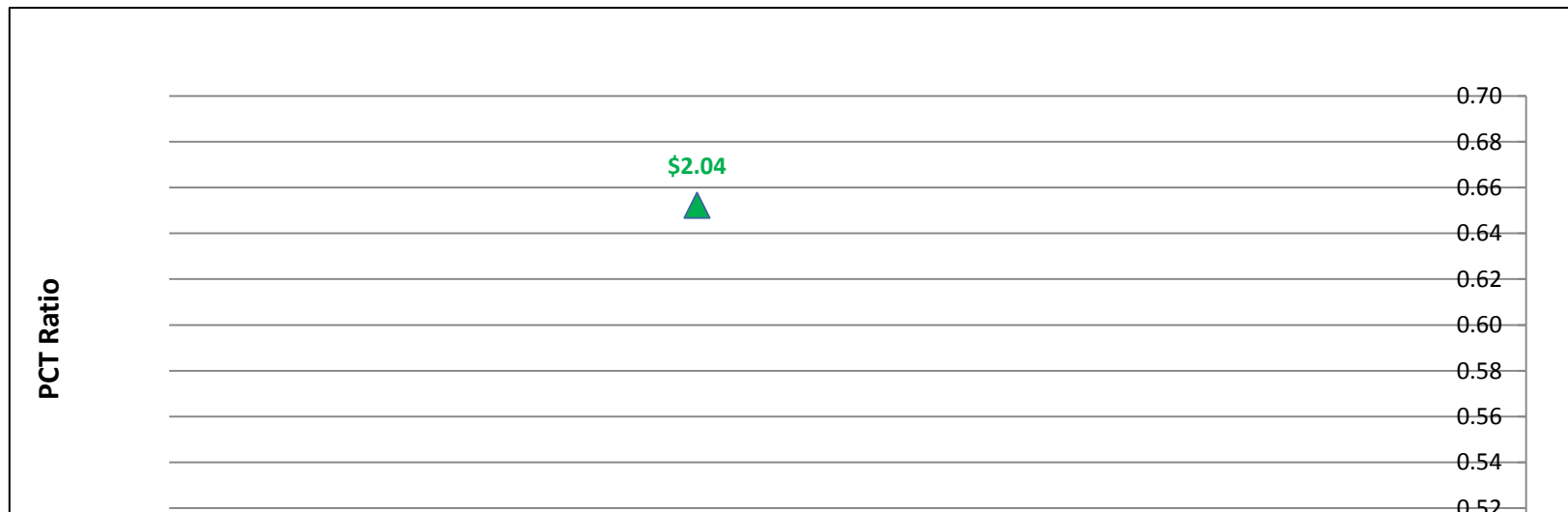


SGIP Cost Effectiveness Report
Participant Test Results (PCT)
MIRR Graphs

ICE500kW w/ Directed BioGas - Government/Non-Profit - SCE

	Rebate (\$/watt)	MIRR	PCT-2014
▲ Actual Rebate - 2014	\$2.04	-27.8%	0.65
■ No Rebate	\$0.00	-100.0%	0.57
● Rebate to Reach MIRR of 5%	\$0.00	0.0%	0.00
● Rebate to Reach MIRR of 6%	\$0.00	0.0%	0.00
● Rebate to Reach MIRR of 7%	\$0.00	0.0%	0.00
● Rebate to Reach MIRR of 8%	\$0.00	0.0%	0.00
● Rebate to Reach MIRR of 9%	\$0.00	0.0%	0.00
● Rebate to Reach MIRR of 10%	\$0.00	0.0%	0.00
● Rebate to Reach MIRR of 11%	\$0.00	0.0%	0.00
● Rebate to Reach MIRR of 12%	\$0.00	0.0%	0.00
● Rebate to Reach MIRR of 13%	\$0.00	0.0%	0.00
● Rebate to Reach MIRR of 14%	\$0.00	0.0%	0.00
● Rebate to Reach MIRR of 15%	\$0.00	0.0%	0.00

System Cost per Watt: \$2.59



SGIP Cost Effectiveness Report
Participant Test Results (PCT)
MIRR Graphs

ICE500kW w/ Directed BioGas - Government/Non-Profit - SDG&E

	Rebate (\$/watt)	MIRR	PCT-2014
▲ Actual Rebate - 2014	\$2.04	-26.2%	0.79
■ No Rebate	\$0.00	-100.0%	0.72
● Rebate to Reach MIRR of 5%	\$0.00	0.0%	0.00
● Rebate to Reach MIRR of 6%	\$0.00	0.0%	0.00
● Rebate to Reach MIRR of 7%	\$0.00	0.0%	0.00
● Rebate to Reach MIRR of 8%	\$0.00	0.0%	0.00
● Rebate to Reach MIRR of 9%	\$0.00	0.0%	0.00
● Rebate to Reach MIRR of 10%	\$0.00	0.0%	0.00
● Rebate to Reach MIRR of 11%	\$0.00	0.0%	0.00
● Rebate to Reach MIRR of 12%	\$0.00	0.0%	0.00
● Rebate to Reach MIRR of 13%	\$0.00	0.0%	0.00
● Rebate to Reach MIRR of 14%	\$0.00	0.0%	0.00
● Rebate to Reach MIRR of 15%	\$0.00	0.0%	0.00

System Cost per Watt: \$2.59

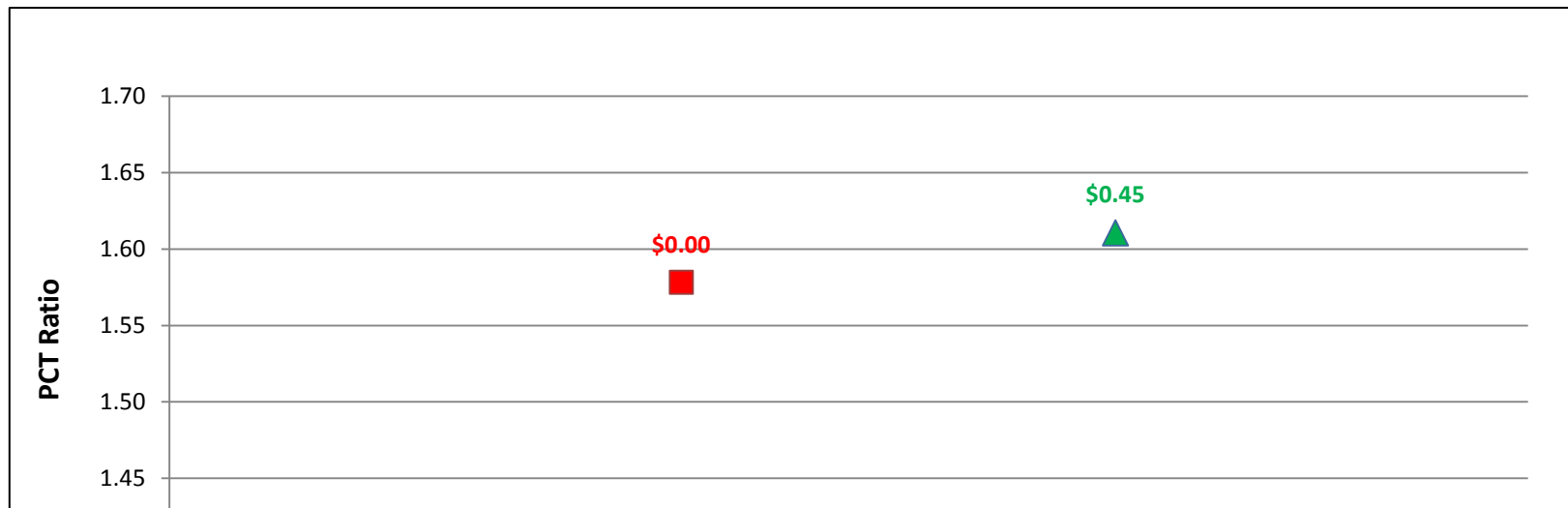


SGIP Cost Effectiveness Report
Participant Test Results (PCT)
MIRR Graphs

ICE500kW w/ Natural Gas - Government/Non-Profit - PG&E

	Rebate (\$/watt)	MIRR	PCT-2014
▲ Actual Rebate - 2014	\$0.45	17.5%	1.61
■ No Rebate	\$0.00	15.9%	1.58
● Rebate to Reach MIRR of 5%	\$0.00	0.0%	0.00
● Rebate to Reach MIRR of 6%	\$0.00	0.0%	0.00
● Rebate to Reach MIRR of 7%	\$0.00	0.0%	0.00
● Rebate to Reach MIRR of 8%	\$0.00	0.0%	0.00
● Rebate to Reach MIRR of 9%	\$0.00	0.0%	0.00
● Rebate to Reach MIRR of 10%	\$0.00	0.0%	0.00
● Rebate to Reach MIRR of 11%	\$0.00	0.0%	0.00
● Rebate to Reach MIRR of 12%	\$0.00	0.0%	0.00
● Rebate to Reach MIRR of 13%	\$0.00	0.0%	0.00
● Rebate to Reach MIRR of 14%	\$0.00	0.0%	0.00
● Rebate to Reach MIRR of 15%	\$0.00	0.0%	0.00

System Cost per Watt: \$2.59

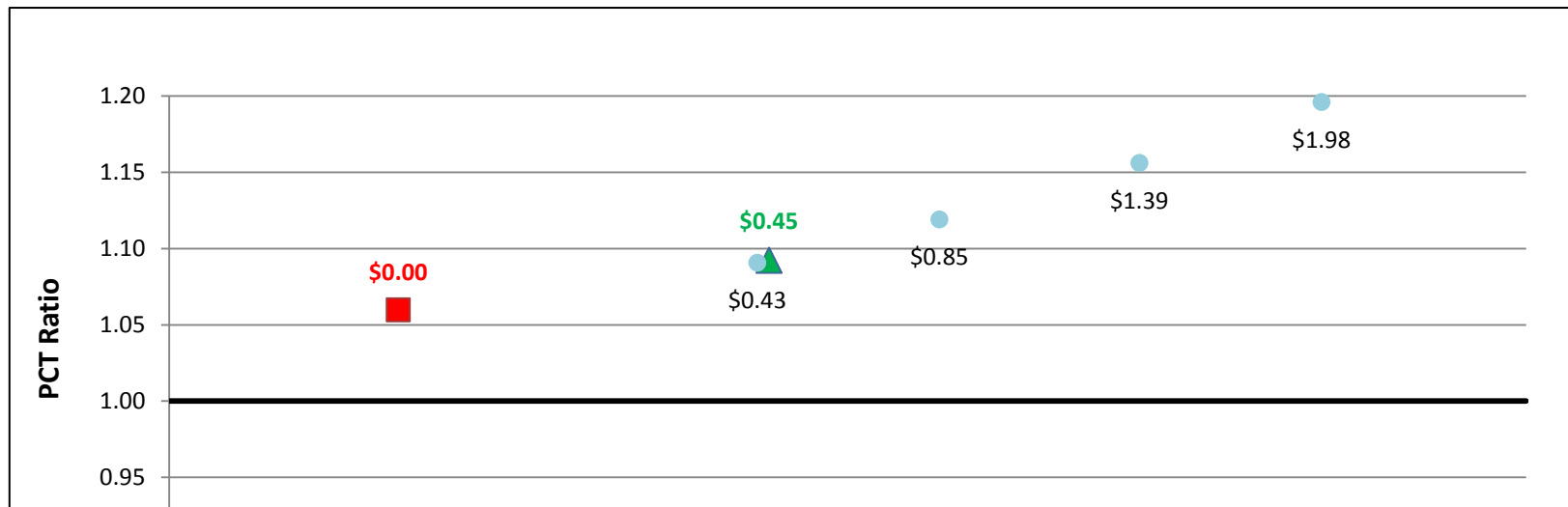


SGIP Cost Effectiveness Report
Participant Test Results (PCT)
MIRR Graphs

ICE500kW w/ Natural Gas - Government/Non-Profit - SCE

	Rebate (\$/watt)	MIRR	PCT-2014
▲ Actual Rebate - 2014	\$0.45	9.1%	1.09
■ No Rebate	\$0.00	7.2%	1.06
● Rebate to Reach MIRR of 5%	\$0.00	0.0%	0.00
● Rebate to Reach MIRR of 6%	\$0.00	0.0%	0.00
● Rebate to Reach MIRR of 7%	\$0.00	0.0%	0.00
● Rebate to Reach MIRR of 8%	\$0.00	0.0%	0.00
● Rebate to Reach MIRR of 9%	\$0.43	9.0%	1.09
● Rebate to Reach MIRR of 10%	\$0.85	10.0%	1.12
● Rebate to Reach MIRR of 11%	\$1.39	11.0%	1.16
● Rebate to Reach MIRR of 12%	\$1.98	11.9%	1.20
● Rebate to Reach MIRR of 13%	\$0.00	0.0%	0.00
● Rebate to Reach MIRR of 14%	\$0.00	0.0%	0.00
● Rebate to Reach MIRR of 15%	\$0.00	0.0%	0.00

System Cost per Watt: \$2.59

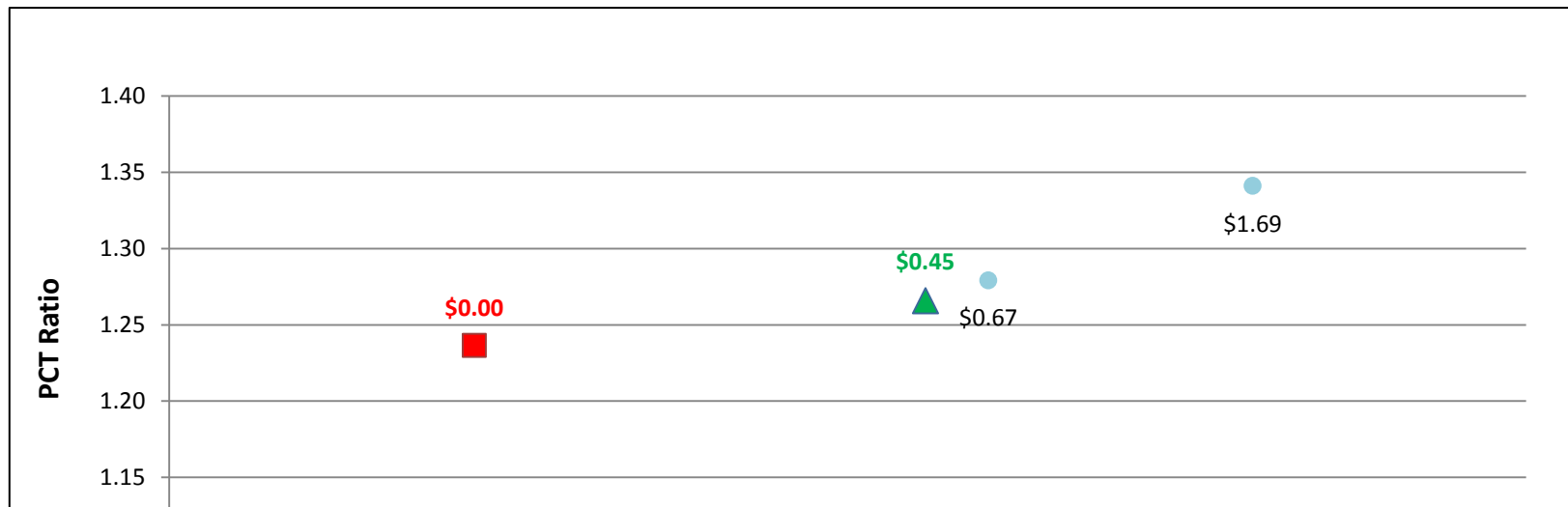


SGIP Cost Effectiveness Report
Participant Test Results (PCT)
MIRR Graphs

ICE500kW w/ Natural Gas - Government/Non-Profit - SDG&E

	Rebate (\$/watt)	MIRR	PCT-2014
▲ Actual Rebate - 2014	\$0.45	13.8%	1.27
■ No Rebate	\$0.00	12.1%	1.24
● Rebate to Reach MIRR of 5%	\$0.00	0.0%	0.00
● Rebate to Reach MIRR of 6%	\$0.00	0.0%	0.00
● Rebate to Reach MIRR of 7%	\$0.00	0.0%	0.00
● Rebate to Reach MIRR of 8%	\$0.00	0.0%	0.00
● Rebate to Reach MIRR of 9%	\$0.00	0.0%	0.00
● Rebate to Reach MIRR of 10%	\$0.00	0.0%	0.00
● Rebate to Reach MIRR of 11%	\$0.00	0.0%	0.00
● Rebate to Reach MIRR of 12%	\$0.00	0.0%	0.00
● Rebate to Reach MIRR of 13%	\$0.00	0.0%	0.00
● Rebate to Reach MIRR of 14%	\$0.67	14.0%	1.28
● Rebate to Reach MIRR of 15%	\$1.69	15.0%	1.34

System Cost per Watt: \$2.59

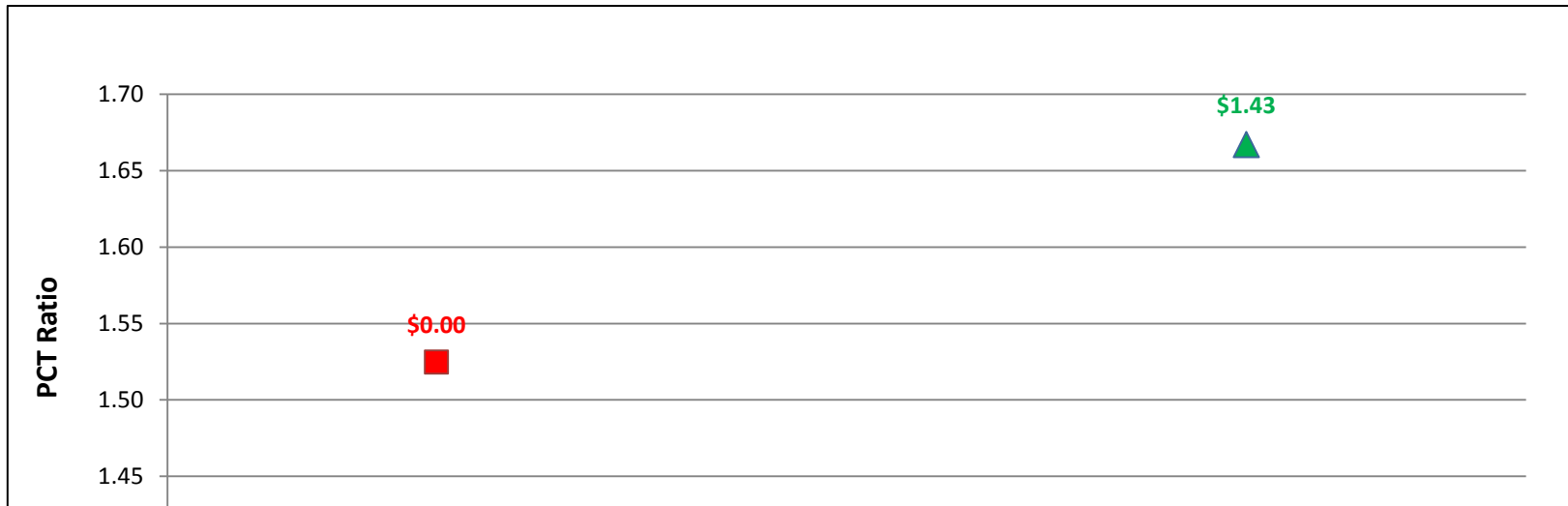


SGIP Cost Effectiveness Report
Participant Test Results (PCT)
MIRR Graphs

ICE500kW w/ On-Site BioGas - Government/Non-Profit - PG&E

	Rebate (\$/watt)	MIRR	PCT-2014
▲ Actual Rebate - 2014	\$1.43	18.1%	1.67
■ No Rebate	\$0.00	12.8%	1.52
● Rebate to Reach MIRR of 5%	\$0.00	0.0%	0.00
● Rebate to Reach MIRR of 6%	\$0.00	0.0%	0.00
● Rebate to Reach MIRR of 7%	\$0.00	0.0%	0.00
● Rebate to Reach MIRR of 8%	\$0.00	0.0%	0.00
● Rebate to Reach MIRR of 9%	\$0.00	0.0%	0.00
● Rebate to Reach MIRR of 10%	\$0.00	0.0%	0.00
● Rebate to Reach MIRR of 11%	\$0.00	0.0%	0.00
● Rebate to Reach MIRR of 12%	\$0.00	0.0%	0.00
● Rebate to Reach MIRR of 13%	\$0.00	0.0%	0.00
● Rebate to Reach MIRR of 14%	\$0.00	0.0%	0.00
● Rebate to Reach MIRR of 15%	\$0.00	0.0%	0.00

System Cost per Watt: \$3.22

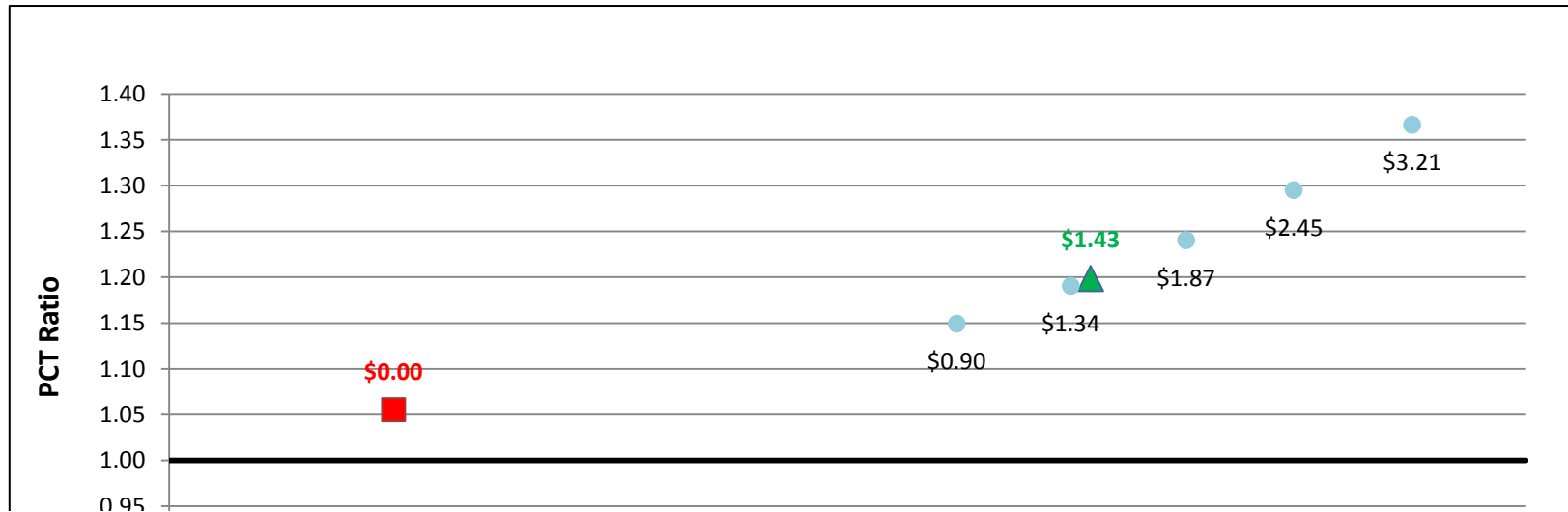


SGIP Cost Effectiveness Report
Participant Test Results (PCT)
MIRR Graphs

ICE500kW w/ On-Site BioGas - Government/Non-Profit - SCE

	Rebate (\$/watt)	MIRR	PCT-2014
▲ Actual Rebate - 2014	\$1.43	12.1%	1.20
■ No Rebate	\$0.00	6.0%	1.05
● Rebate to Reach MIRR of 5%	\$0.00	0.0%	0.00
● Rebate to Reach MIRR of 6%	\$0.00	0.0%	0.00
● Rebate to Reach MIRR of 7%	\$0.00	0.0%	0.00
● Rebate to Reach MIRR of 8%	\$0.00	0.0%	0.00
● Rebate to Reach MIRR of 9%	\$0.00	0.0%	0.00
● Rebate to Reach MIRR of 10%	\$0.00	0.0%	0.00
● Rebate to Reach MIRR of 11%	\$0.90	11.0%	1.15
● Rebate to Reach MIRR of 12%	\$1.34	12.0%	1.19
● Rebate to Reach MIRR of 13%	\$1.87	13.0%	1.24
● Rebate to Reach MIRR of 14%	\$2.45	13.9%	1.29
● Rebate to Reach MIRR of 15%	\$3.21	15.0%	1.37

System Cost per Watt: \$3.22

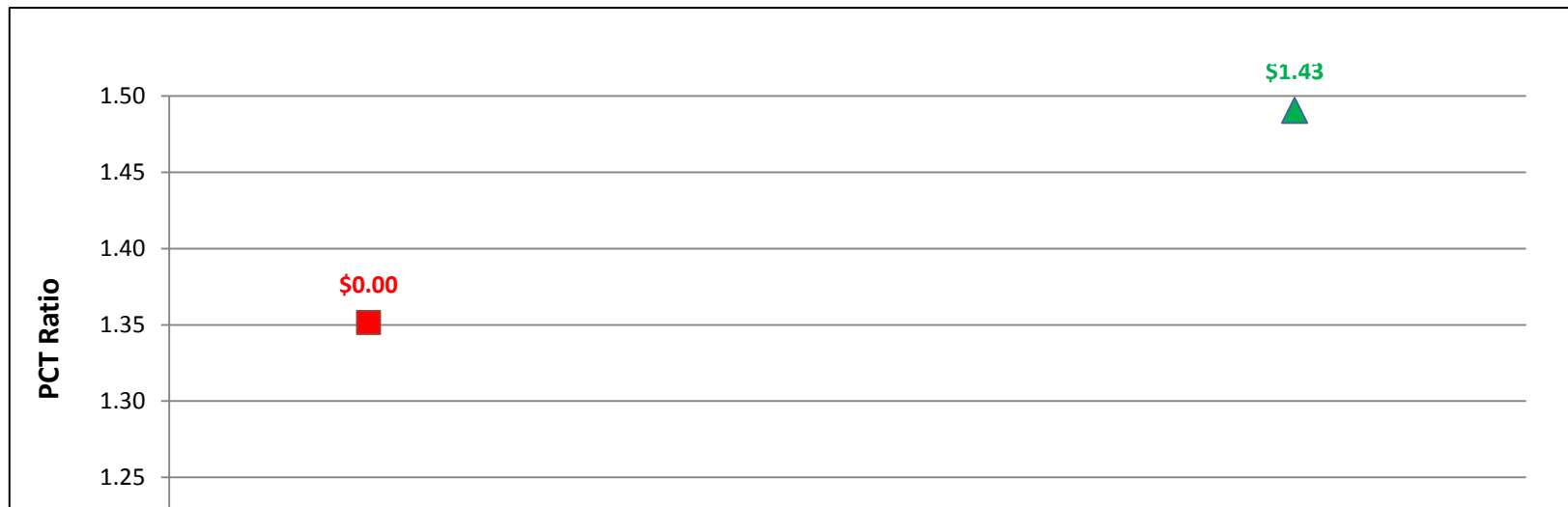


SGIP Cost Effectiveness Report
Participant Test Results (PCT)
MIRR Graphs

ICE500kW w/ On-Site BioGas - Government/Non-Profit - SDG&E

	Rebate (\$/watt)	MIRR	PCT-2014
▲ Actual Rebate - 2014	\$1.43	16.6%	1.49
■ No Rebate	\$0.00	11.2%	1.35
● Rebate to Reach MIRR of 5%	\$0.00	0.0%	0.00
● Rebate to Reach MIRR of 6%	\$0.00	0.0%	0.00
● Rebate to Reach MIRR of 7%	\$0.00	0.0%	0.00
● Rebate to Reach MIRR of 8%	\$0.00	0.0%	0.00
● Rebate to Reach MIRR of 9%	\$0.00	0.0%	0.00
● Rebate to Reach MIRR of 10%	\$0.00	0.0%	0.00
● Rebate to Reach MIRR of 11%	\$0.00	0.0%	0.00
● Rebate to Reach MIRR of 12%	\$0.00	0.0%	0.00
● Rebate to Reach MIRR of 13%	\$0.00	0.0%	0.00
● Rebate to Reach MIRR of 14%	\$0.00	0.0%	0.00
● Rebate to Reach MIRR of 15%	\$0.00	0.0%	0.00

System Cost per Watt: \$3.22

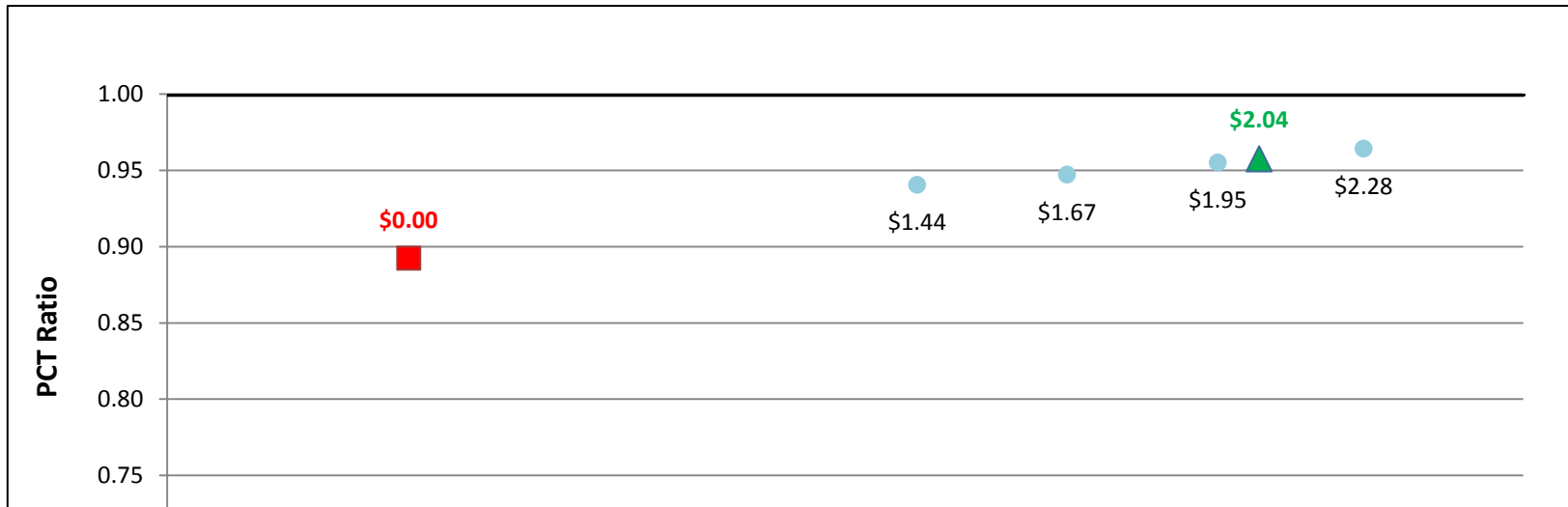


SGIP Cost Effectiveness Report
 Participant Test Results (PCT)
 MIRR Graphs

ICE500kW w/ Directed BioGas - Commercial - PG&E

	Rebate (\$/watt)	MIRR	PCT-2014
▲ Actual Rebate - 2014	\$2.04	7.2%	0.96
■ No Rebate	\$0.00	1.6%	0.89
● Rebate to Reach MIRR of 5%	\$1.44	5.0%	0.94
● Rebate to Reach MIRR of 6%	\$1.67	6.0%	0.95
● Rebate to Reach MIRR of 7%	\$1.95	7.0%	0.96
● Rebate to Reach MIRR of 8%	\$2.28	7.9%	0.96
● Rebate to Reach MIRR of 9%	\$0.00	0.0%	0.00
● Rebate to Reach MIRR of 10%	\$0.00	0.0%	0.00
● Rebate to Reach MIRR of 11%	\$0.00	0.0%	0.00
● Rebate to Reach MIRR of 12%	\$0.00	0.0%	0.00
● Rebate to Reach MIRR of 13%	\$0.00	0.0%	0.00
● Rebate to Reach MIRR of 14%	\$0.00	0.0%	0.00
● Rebate to Reach MIRR of 15%	\$0.00	0.0%	0.00

System Cost per Watt: \$2.59

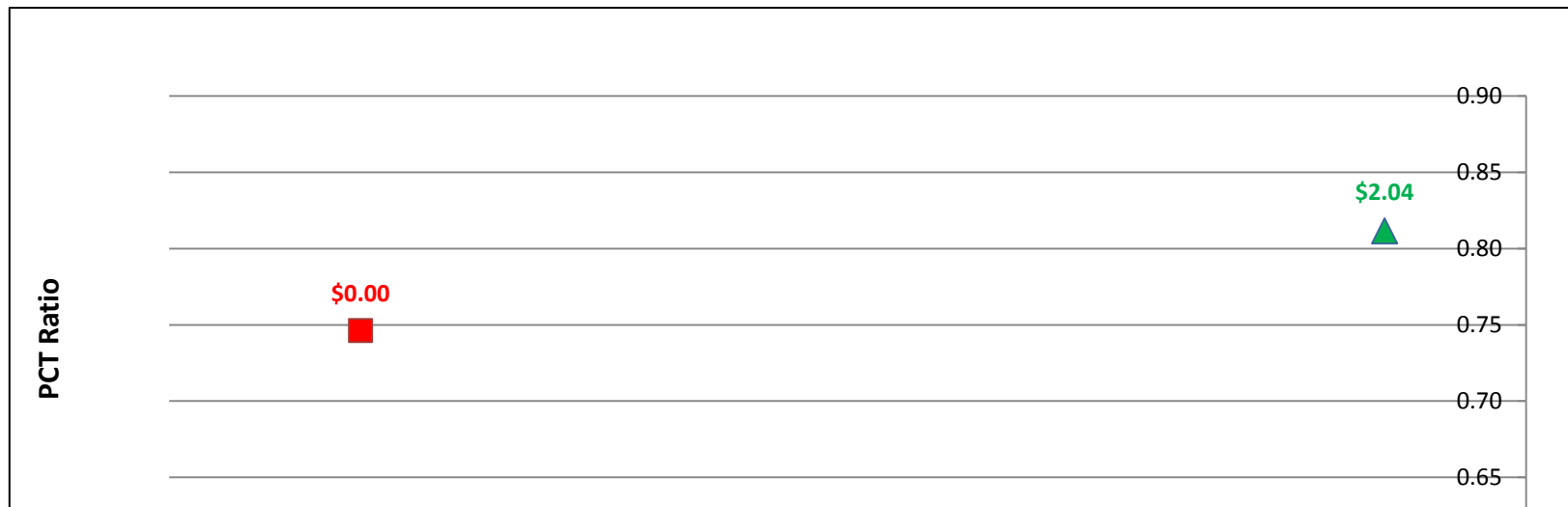


SGIP Cost Effectiveness Report
 Participant Test Results (PCT)
 MIRR Graphs

ICE500kW w/ Directed BioGas - Commercial - SCE

	Rebate (\$/watt)	MIRR	PCT-2014
▲ Actual Rebate - 2014	\$2.04	-4.1%	0.81
■ No Rebate	\$0.00	-12.4%	0.75
● Rebate to Reach MIRR of 5%	\$0.00	0.0%	0.00
● Rebate to Reach MIRR of 6%	\$0.00	0.0%	0.00
● Rebate to Reach MIRR of 7%	\$0.00	0.0%	0.00
● Rebate to Reach MIRR of 8%	\$0.00	0.0%	0.00
● Rebate to Reach MIRR of 9%	\$0.00	0.0%	0.00
● Rebate to Reach MIRR of 10%	\$0.00	0.0%	0.00
● Rebate to Reach MIRR of 11%	\$0.00	0.0%	0.00
● Rebate to Reach MIRR of 12%	\$0.00	0.0%	0.00
● Rebate to Reach MIRR of 13%	\$0.00	0.0%	0.00
● Rebate to Reach MIRR of 14%	\$0.00	0.0%	0.00
● Rebate to Reach MIRR of 15%	\$0.00	0.0%	0.00

System Cost per Watt: \$2.59

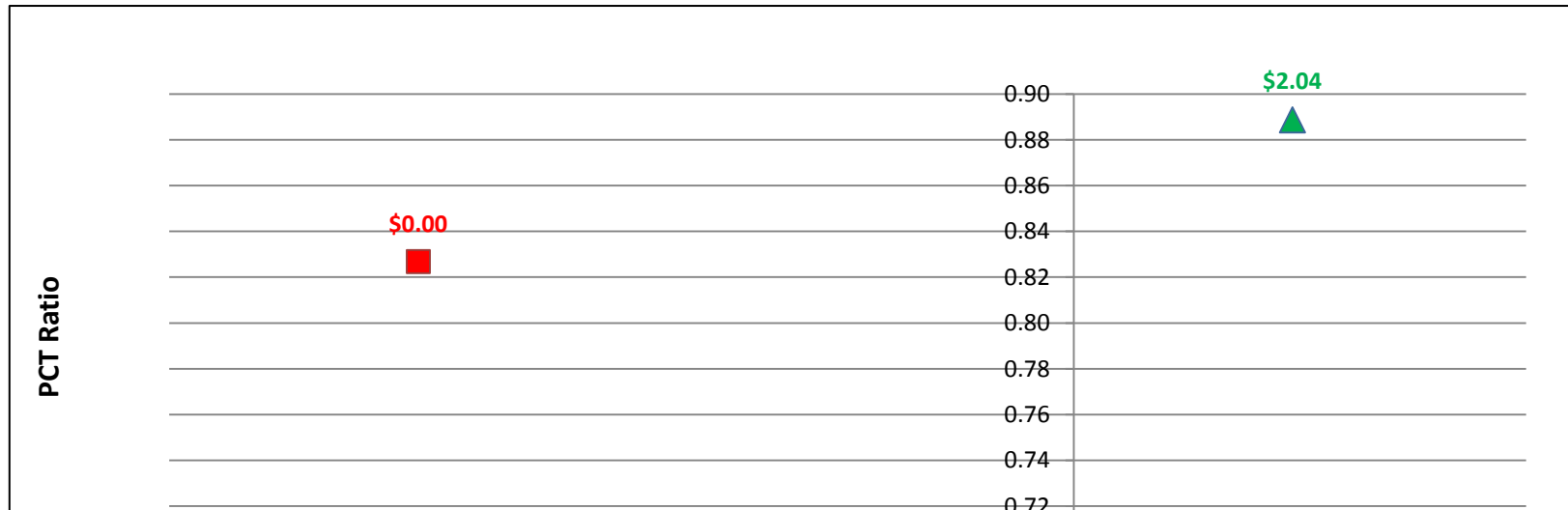


SGIP Cost Effectiveness Report
Participant Test Results (PCT)
MIRR Graphs

ICE500kW w/ Directed BioGas - Commercial - SDG&E

	Rebate (\$/watt)	MIRR	PCT-2014
▲ Actual Rebate - 2014	\$2.04	1.5%	0.89
■ No Rebate	\$0.00	-4.3%	0.83
● Rebate to Reach MIRR of 5%	\$0.00	0.0%	0.00
● Rebate to Reach MIRR of 6%	\$0.00	0.0%	0.00
● Rebate to Reach MIRR of 7%	\$0.00	0.0%	0.00
● Rebate to Reach MIRR of 8%	\$0.00	0.0%	0.00
● Rebate to Reach MIRR of 9%	\$0.00	0.0%	0.00
● Rebate to Reach MIRR of 10%	\$0.00	0.0%	0.00
● Rebate to Reach MIRR of 11%	\$0.00	0.0%	0.00
● Rebate to Reach MIRR of 12%	\$0.00	0.0%	0.00
● Rebate to Reach MIRR of 13%	\$0.00	0.0%	0.00
● Rebate to Reach MIRR of 14%	\$0.00	0.0%	0.00
● Rebate to Reach MIRR of 15%	\$0.00	0.0%	0.00

System Cost per Watt: \$2.59

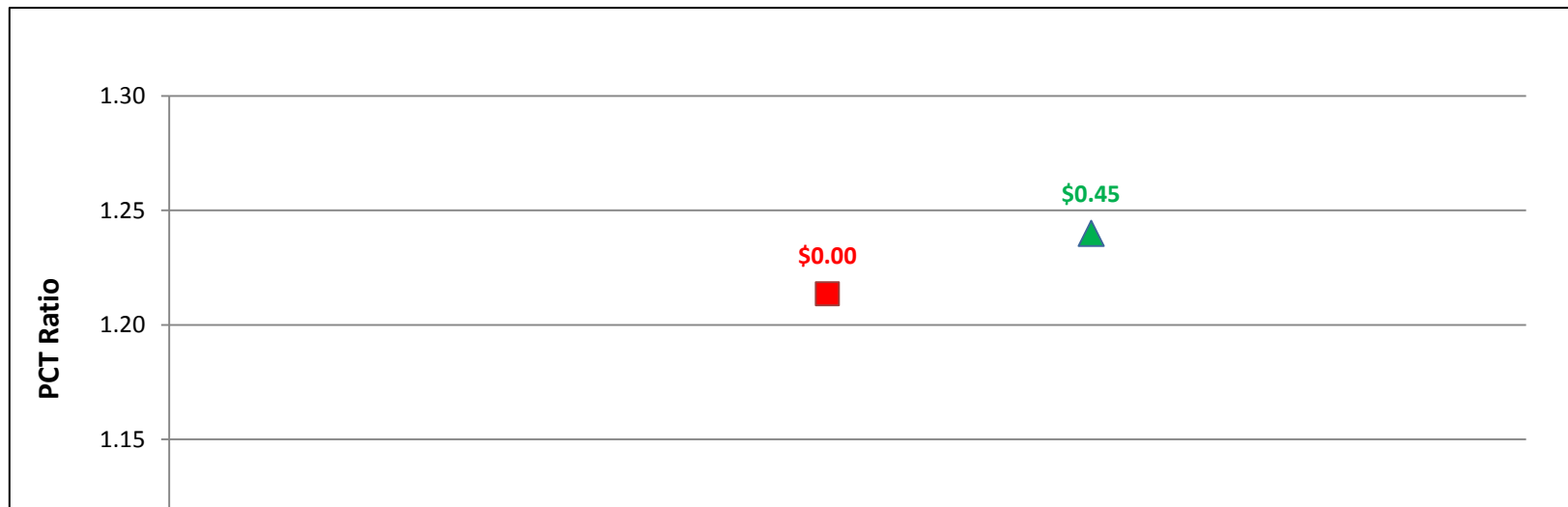


SGIP Cost Effectiveness Report
Participant Test Results (PCT)
MIRR Graphs

ICE500kW w/ Natural Gas - Commercial - PG&E

	Rebate (\$/watt)	MIRR	PCT-2014
▲ Actual Rebate - 2014	\$0.45	15.7%	1.24
■ No Rebate	\$0.00	14.9%	1.21
● Rebate to Reach MIRR of 5%	\$0.00	0.0%	0.00
● Rebate to Reach MIRR of 6%	\$0.00	0.0%	0.00
● Rebate to Reach MIRR of 7%	\$0.00	0.0%	0.00
● Rebate to Reach MIRR of 8%	\$0.00	0.0%	0.00
● Rebate to Reach MIRR of 9%	\$0.00	0.0%	0.00
● Rebate to Reach MIRR of 10%	\$0.00	0.0%	0.00
● Rebate to Reach MIRR of 11%	\$0.00	0.0%	0.00
● Rebate to Reach MIRR of 12%	\$0.00	0.0%	0.00
● Rebate to Reach MIRR of 13%	\$0.00	0.0%	0.00
● Rebate to Reach MIRR of 14%	\$0.00	0.0%	0.00
● Rebate to Reach MIRR of 15%	\$0.00	0.0%	0.00

System Cost per Watt: \$2.59



SGIP Cost Effectiveness Report
Participant Test Results (PCT)
MIRR Graphs

ICE500kW w/ Natural Gas - Commercial - SCE

	Rebate (\$/watt)	MIRR	PCT-2014
▲ Actual Rebate - 2014	\$0.45	9.2%	0.97
■ No Rebate	\$0.00	8.1%	0.94
● Rebate to Reach MIRR of 5%	\$0.00	0.0%	0.00
● Rebate to Reach MIRR of 6%	\$0.00	0.0%	0.00
● Rebate to Reach MIRR of 7%	\$0.00	0.0%	0.00
● Rebate to Reach MIRR of 8%	\$0.00	0.0%	0.00
● Rebate to Reach MIRR of 9%	\$0.38	9.0%	0.96
● Rebate to Reach MIRR of 10%	\$0.80	10.0%	0.98
● Rebate to Reach MIRR of 11%	\$1.39	11.1%	1.01
● Rebate to Reach MIRR of 12%	\$1.97	12.0%	1.05
● Rebate to Reach MIRR of 13%	\$0.00	0.0%	0.00
● Rebate to Reach MIRR of 14%	\$0.00	0.0%	0.00
● Rebate to Reach MIRR of 15%	\$0.00	0.0%	0.00

System Cost per Watt: \$2.59



SGIP Cost Effectiveness Report
Participant Test Results (PCT)
MIRR Graphs

ICE500kW w/ Natural Gas - Commercial - SDG&E

	Rebate (\$/watt)	MIRR	PCT-2014
▲ Actual Rebate - 2014	\$0.45	13.0%	1.08
■ No Rebate	\$0.00	12.2%	1.06
● Rebate to Reach MIRR of 5%	\$0.00	0.0%	0.00
● Rebate to Reach MIRR of 6%	\$0.00	0.0%	0.00
● Rebate to Reach MIRR of 7%	\$0.00	0.0%	0.00
● Rebate to Reach MIRR of 8%	\$0.00	0.0%	0.00
● Rebate to Reach MIRR of 9%	\$0.00	0.0%	0.00
● Rebate to Reach MIRR of 10%	\$0.00	0.0%	0.00
● Rebate to Reach MIRR of 11%	\$0.00	0.0%	0.00
● Rebate to Reach MIRR of 12%	\$0.00	0.0%	0.00
● Rebate to Reach MIRR of 13%	\$0.43	13.0%	1.08
● Rebate to Reach MIRR of 14%	\$1.22	14.0%	1.12
● Rebate to Reach MIRR of 15%	\$2.12	14.9%	1.16

System Cost per Watt: \$2.59

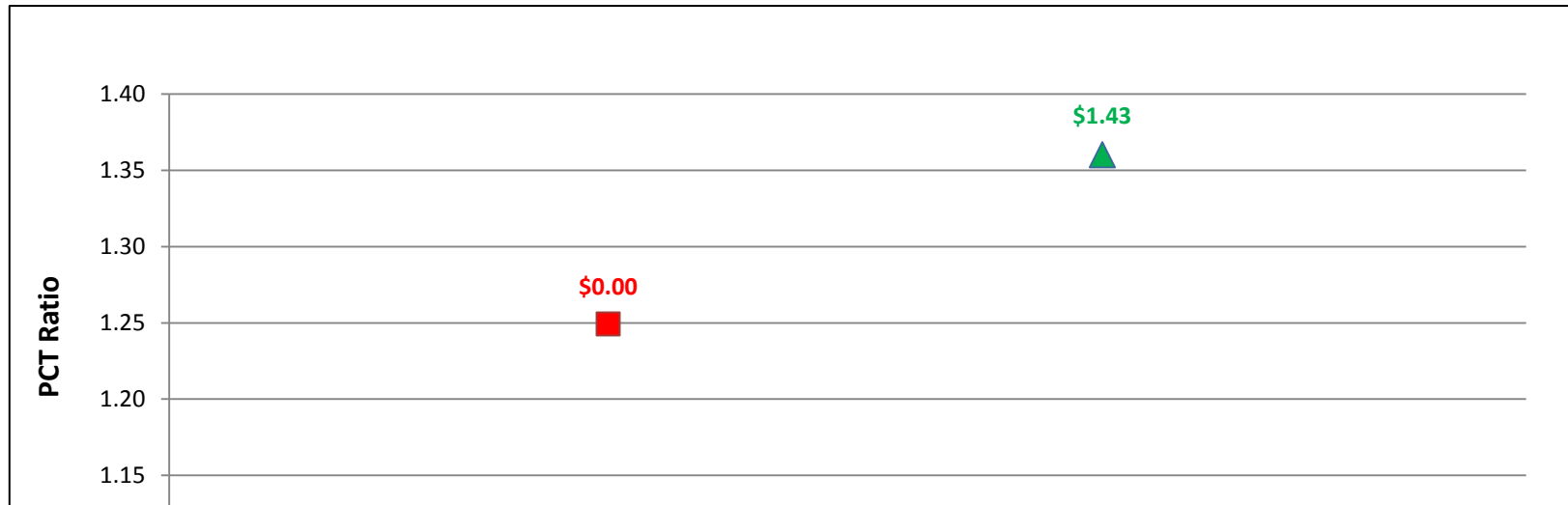


SGIP Cost Effectiveness Report
Participant Test Results (PCT)
MIRR Graphs

ICE500kW w/ On-Site BioGas - Commercial - PG&E

	Rebate (\$/watt)	MIRR	PCT-2014
▲ Actual Rebate - 2014	\$1.43	16.1%	1.36
■ No Rebate	\$0.00	13.9%	1.25
● Rebate to Reach MIRR of 5%	\$0.00	0.0%	0.00
● Rebate to Reach MIRR of 6%	\$0.00	0.0%	0.00
● Rebate to Reach MIRR of 7%	\$0.00	0.0%	0.00
● Rebate to Reach MIRR of 8%	\$0.00	0.0%	0.00
● Rebate to Reach MIRR of 9%	\$0.00	0.0%	0.00
● Rebate to Reach MIRR of 10%	\$0.00	0.0%	0.00
● Rebate to Reach MIRR of 11%	\$0.00	0.0%	0.00
● Rebate to Reach MIRR of 12%	\$0.00	0.0%	0.00
● Rebate to Reach MIRR of 13%	\$0.00	0.0%	0.00
● Rebate to Reach MIRR of 14%	\$0.00	0.0%	0.00
● Rebate to Reach MIRR of 15%	\$0.00	0.0%	0.00

System Cost per Watt: \$3.22

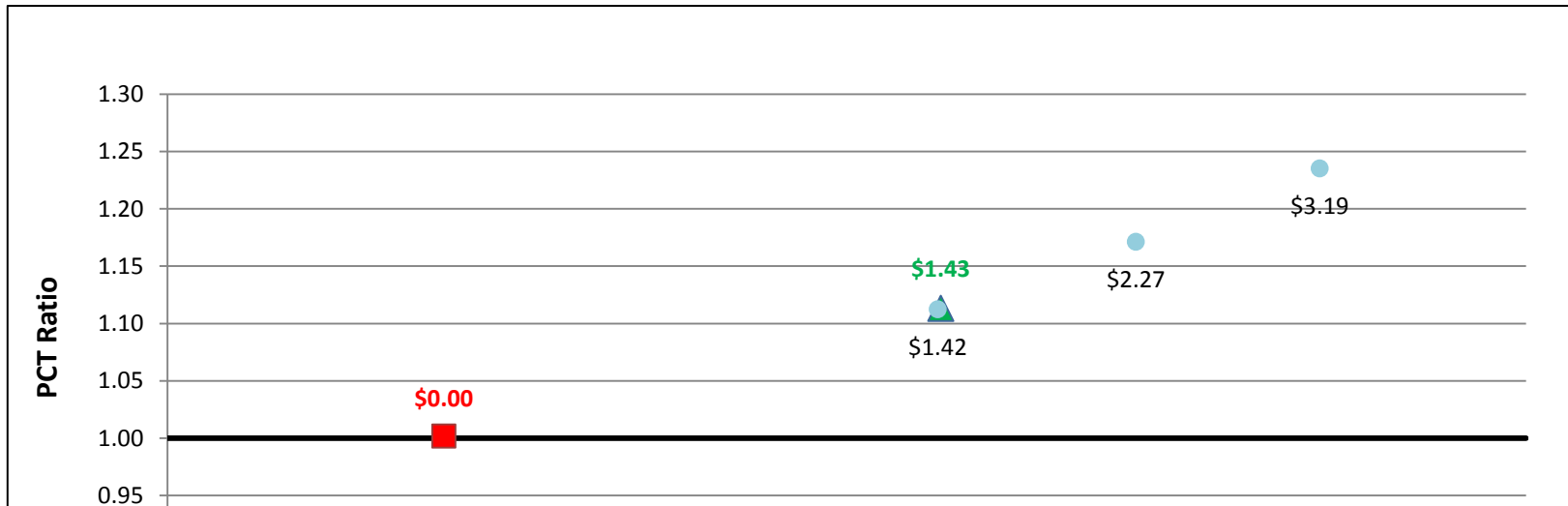


SGIP Cost Effectiveness Report
Participant Test Results (PCT)
MIRR Graphs

ICE500kW w/ On-Site BioGas - Commercial - SCE

	Rebate (\$/watt)	MIRR	PCT-2014
▲ Actual Rebate - 2014	\$1.43	13.0%	1.11
■ No Rebate	\$0.00	10.4%	1.00
● Rebate to Reach MIRR of 5%	\$0.00	0.0%	0.00
● Rebate to Reach MIRR of 6%	\$0.00	0.0%	0.00
● Rebate to Reach MIRR of 7%	\$0.00	0.0%	0.00
● Rebate to Reach MIRR of 8%	\$0.00	0.0%	0.00
● Rebate to Reach MIRR of 9%	\$0.00	0.0%	0.00
● Rebate to Reach MIRR of 10%	\$0.00	0.0%	0.00
● Rebate to Reach MIRR of 11%	\$0.00	0.0%	0.00
● Rebate to Reach MIRR of 12%	\$0.00	0.0%	0.00
● Rebate to Reach MIRR of 13%	\$1.42	13.0%	1.11
● Rebate to Reach MIRR of 14%	\$2.27	14.0%	1.17
● Rebate to Reach MIRR of 15%	\$3.19	14.9%	1.24

System Cost per Watt: \$3.22

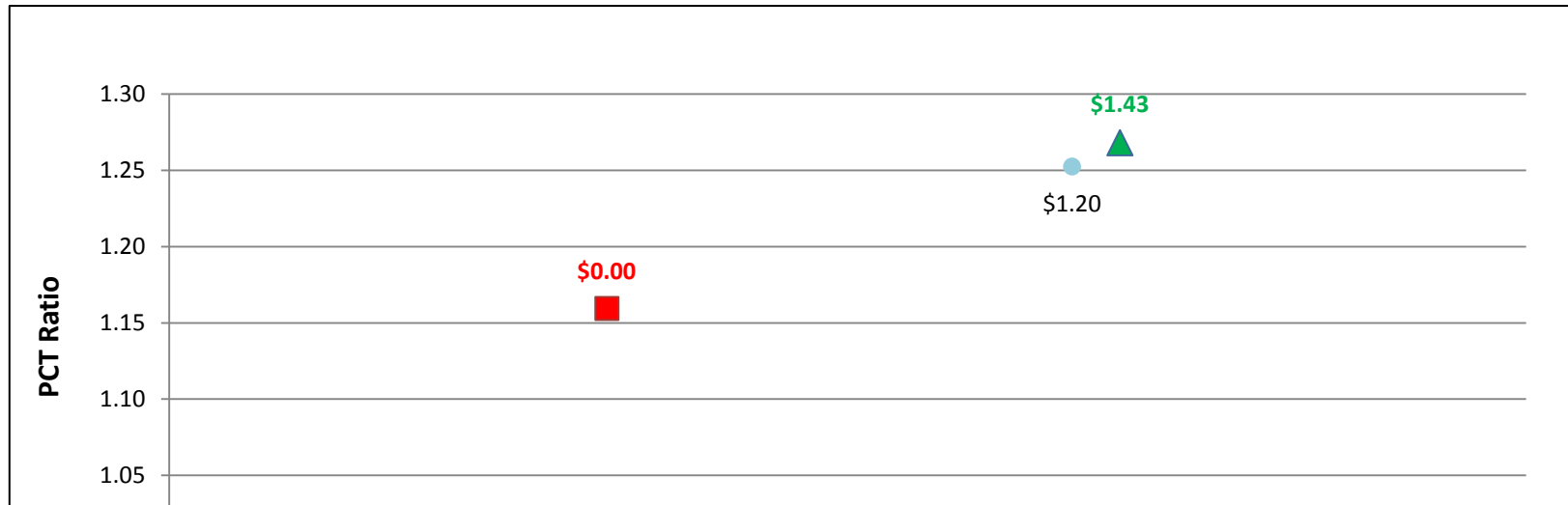


SGIP Cost Effectiveness Report
Participant Test Results (PCT)
MIRR Graphs

ICE500kW w/ On-Site BioGas - Commercial - SDG&E

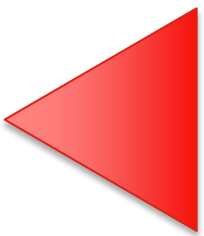
	Rebate (\$/watt)	MIRR	PCT-2014
▲ Actual Rebate - 2014	\$1.43	15.2%	1.27
■ No Rebate	\$0.00	12.9%	1.16
● Rebate to Reach MIRR of 5%	\$0.00	0.0%	0.00
● Rebate to Reach MIRR of 6%	\$0.00	0.0%	0.00
● Rebate to Reach MIRR of 7%	\$0.00	0.0%	0.00
● Rebate to Reach MIRR of 8%	\$0.00	0.0%	0.00
● Rebate to Reach MIRR of 9%	\$0.00	0.0%	0.00
● Rebate to Reach MIRR of 10%	\$0.00	0.0%	0.00
● Rebate to Reach MIRR of 11%	\$0.00	0.0%	0.00
● Rebate to Reach MIRR of 12%	\$0.00	0.0%	0.00
● Rebate to Reach MIRR of 13%	\$0.00	0.0%	0.00
● Rebate to Reach MIRR of 14%	\$0.00	0.0%	0.00
● Rebate to Reach MIRR of 15%	\$1.20	15.0%	1.25

System Cost per Watt: \$3.22





Microturbines



SGIP Cost Effectiveness Report
Participant Test Results (PCT)
MIRR Graphs

MT200kW w/ Directed BioGas - Government/Non-Profit - PG&E

	Rebate (\$/watt)	MIRR	PCT-2014
▲ Actual Rebate - 2014	\$1.94	-100.0%	0.55
■ No Rebate	\$0.00	-100.0%	0.49
● Rebate to Reach MIRR of 5%	\$0.00	0.0%	0.00
● Rebate to Reach MIRR of 6%	\$0.00	0.0%	0.00
● Rebate to Reach MIRR of 7%	\$0.00	0.0%	0.00
● Rebate to Reach MIRR of 8%	\$0.00	0.0%	0.00
● Rebate to Reach MIRR of 9%	\$0.00	0.0%	0.00
● Rebate to Reach MIRR of 10%	\$0.00	0.0%	0.00
● Rebate to Reach MIRR of 11%	\$0.00	0.0%	0.00
● Rebate to Reach MIRR of 12%	\$0.00	0.0%	0.00
● Rebate to Reach MIRR of 13%	\$0.00	0.0%	0.00
● Rebate to Reach MIRR of 14%	\$0.00	0.0%	0.00
● Rebate to Reach MIRR of 15%	\$0.00	0.0%	0.00

System Cost per Watt: \$3.14



SGIP Cost Effectiveness Report
Participant Test Results (PCT)
MIRR Graphs

MT200kW w/ Directed BioGas - Government/Non-Profit - SCE

	Rebate (\$/watt)	MIRR	PCT-2014
▲ Actual Rebate - 2014	\$1.94	-100.0%	0.40
■ No Rebate	\$0.00	-100.0%	0.34
● Rebate to Reach MIRR of 5%	\$0.00	0.0%	0.00
● Rebate to Reach MIRR of 6%	\$0.00	0.0%	0.00
● Rebate to Reach MIRR of 7%	\$0.00	0.0%	0.00
● Rebate to Reach MIRR of 8%	\$0.00	0.0%	0.00
● Rebate to Reach MIRR of 9%	\$0.00	0.0%	0.00
● Rebate to Reach MIRR of 10%	\$0.00	0.0%	0.00
● Rebate to Reach MIRR of 11%	\$0.00	0.0%	0.00
● Rebate to Reach MIRR of 12%	\$0.00	0.0%	0.00
● Rebate to Reach MIRR of 13%	\$0.00	0.0%	0.00
● Rebate to Reach MIRR of 14%	\$0.00	0.0%	0.00
● Rebate to Reach MIRR of 15%	\$0.00	0.0%	0.00

System Cost per Watt: \$3.14



SGIP Cost Effectiveness Report
Participant Test Results (PCT)
MIRR Graphs

MT200kW w/ Directed BioGas - Government/Non-Profit - SDG&E

	Rebate (\$/watt)	MIRR	PCT-2014
▲ Actual Rebate - 2014	\$1.94	-100.0%	0.48
■ No Rebate	\$0.00	-100.0%	0.42
● Rebate to Reach MIRR of 5%	\$0.00	0.0%	0.00
● Rebate to Reach MIRR of 6%	\$0.00	0.0%	0.00
● Rebate to Reach MIRR of 7%	\$0.00	0.0%	0.00
● Rebate to Reach MIRR of 8%	\$0.00	0.0%	0.00
● Rebate to Reach MIRR of 9%	\$0.00	0.0%	0.00
● Rebate to Reach MIRR of 10%	\$0.00	0.0%	0.00
● Rebate to Reach MIRR of 11%	\$0.00	0.0%	0.00
● Rebate to Reach MIRR of 12%	\$0.00	0.0%	0.00
● Rebate to Reach MIRR of 13%	\$0.00	0.0%	0.00
● Rebate to Reach MIRR of 14%	\$0.00	0.0%	0.00
● Rebate to Reach MIRR of 15%	\$0.00	0.0%	0.00

System Cost per Watt: \$3.14

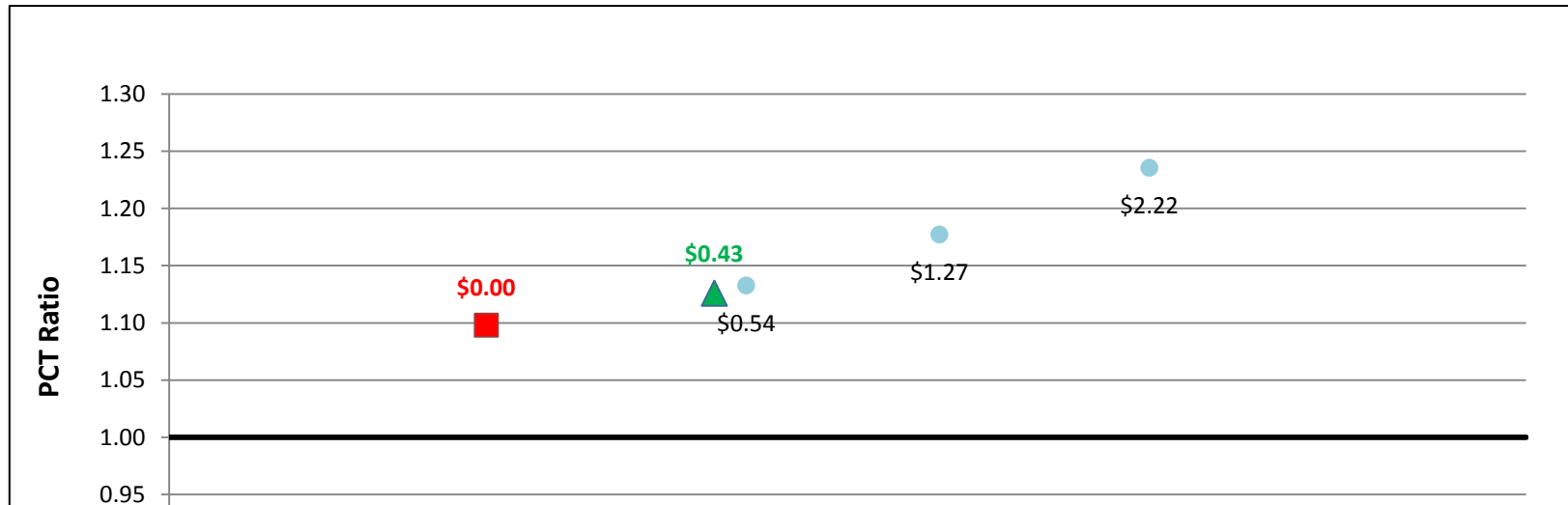


SGIP Cost Effectiveness Report
Participant Test Results (PCT)
MIRR Graphs

MT200kW w/ Natural Gas - Government/Non-Profit - PG&E

	Rebate (\$/watt)	MIRR	PCT-2014
▲ Actual Rebate - 2014	\$0.43	8.8%	1.13
■ No Rebate	\$0.00	7.6%	1.10
● Rebate to Reach MIRR of 5%	\$0.00	0.0%	0.00
● Rebate to Reach MIRR of 6%	\$0.00	0.0%	0.00
● Rebate to Reach MIRR of 7%	\$0.00	0.0%	0.00
● Rebate to Reach MIRR of 8%	\$0.00	0.0%	0.00
● Rebate to Reach MIRR of 9%	\$0.54	9.0%	1.13
● Rebate to Reach MIRR of 10%	\$1.27	10.0%	1.18
● Rebate to Reach MIRR of 11%	\$2.22	11.1%	1.24
● Rebate to Reach MIRR of 12%	\$0.00	0.0%	0.00
● Rebate to Reach MIRR of 13%	\$0.00	0.0%	0.00
● Rebate to Reach MIRR of 14%	\$0.00	0.0%	0.00
● Rebate to Reach MIRR of 15%	\$0.00	0.0%	0.00

System Cost per Watt: \$3.14



SGIP Cost Effectiveness Report
Participant Test Results (PCT)
MIRR Graphs

MT200kW w/ Natural Gas - Government/Non-Profit - SCE

	Rebate (\$/watt)	MIRR	PCT-2014
▲ Actual Rebate - 2014	\$0.43	-7.6%	0.77
■ No Rebate	\$0.00	-10.6%	0.75
● Rebate to Reach MIRR of 5%	\$0.00	0.0%	0.00
● Rebate to Reach MIRR of 6%	\$0.00	0.0%	0.00
● Rebate to Reach MIRR of 7%	\$0.00	0.0%	0.00
● Rebate to Reach MIRR of 8%	\$0.00	0.0%	0.00
● Rebate to Reach MIRR of 9%	\$0.00	0.0%	0.00
● Rebate to Reach MIRR of 10%	\$0.00	0.0%	0.00
● Rebate to Reach MIRR of 11%	\$0.00	0.0%	0.00
● Rebate to Reach MIRR of 12%	\$0.00	0.0%	0.00
● Rebate to Reach MIRR of 13%	\$0.00	0.0%	0.00
● Rebate to Reach MIRR of 14%	\$0.00	0.0%	0.00
● Rebate to Reach MIRR of 15%	\$0.00	0.0%	0.00

System Cost per Watt: \$3.14

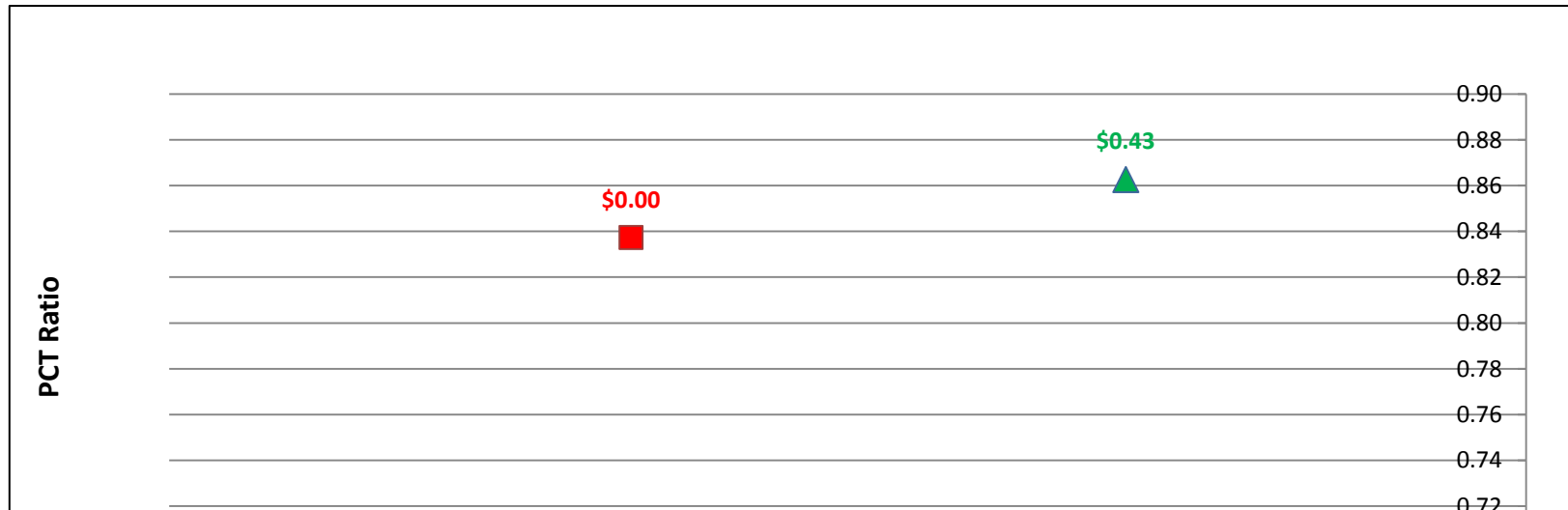


SGIP Cost Effectiveness Report
 Participant Test Results (PCT)
 MIRR Graphs

MT200kW w/ Natural Gas - Government/Non-Profit - SDG&E

	Rebate (\$/watt)	MIRR	PCT-2014
▲ Actual Rebate - 2014	\$0.43	-2.2%	0.86
■ No Rebate	\$0.00	-3.6%	0.84
● Rebate to Reach MIRR of 5%	\$0.00	0.0%	0.00
● Rebate to Reach MIRR of 6%	\$0.00	0.0%	0.00
● Rebate to Reach MIRR of 7%	\$0.00	0.0%	0.00
● Rebate to Reach MIRR of 8%	\$0.00	0.0%	0.00
● Rebate to Reach MIRR of 9%	\$0.00	0.0%	0.00
● Rebate to Reach MIRR of 10%	\$0.00	0.0%	0.00
● Rebate to Reach MIRR of 11%	\$0.00	0.0%	0.00
● Rebate to Reach MIRR of 12%	\$0.00	0.0%	0.00
● Rebate to Reach MIRR of 13%	\$0.00	0.0%	0.00
● Rebate to Reach MIRR of 14%	\$0.00	0.0%	0.00
● Rebate to Reach MIRR of 15%	\$0.00	0.0%	0.00

System Cost per Watt: \$3.14

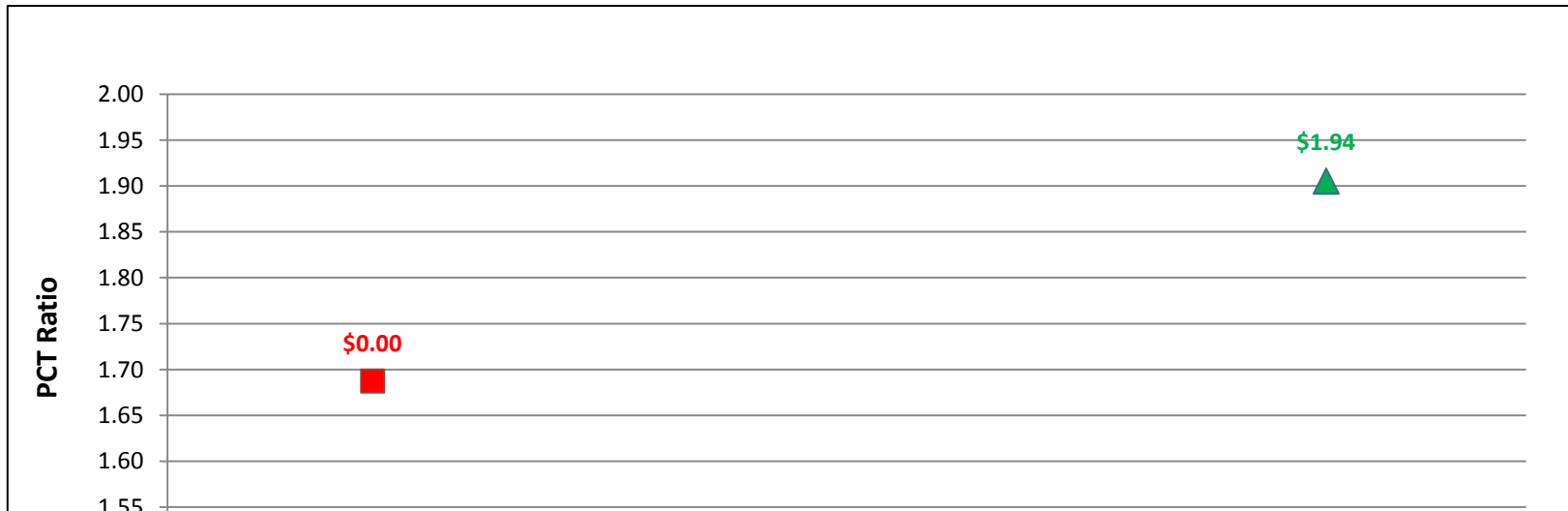


SGIP Cost Effectiveness Report
Participant Test Results (PCT)
MIRR Graphs

MT200kW w/ On-Site BioGas - Government/Non-Profit - PG&E

	Rebate (\$/watt)	MIRR	PCT-2014
▲ Actual Rebate - 2014	\$1.94	18.7%	1.91
■ No Rebate	\$0.00	12.4%	1.69
● Rebate to Reach MIRR of 5%	\$0.00	0.0%	0.00
● Rebate to Reach MIRR of 6%	\$0.00	0.0%	0.00
● Rebate to Reach MIRR of 7%	\$0.00	0.0%	0.00
● Rebate to Reach MIRR of 8%	\$0.00	0.0%	0.00
● Rebate to Reach MIRR of 9%	\$0.00	0.0%	0.00
● Rebate to Reach MIRR of 10%	\$0.00	0.0%	0.00
● Rebate to Reach MIRR of 11%	\$0.00	0.0%	0.00
● Rebate to Reach MIRR of 12%	\$0.00	0.0%	0.00
● Rebate to Reach MIRR of 13%	\$0.00	0.0%	0.00
● Rebate to Reach MIRR of 14%	\$0.00	0.0%	0.00
● Rebate to Reach MIRR of 15%	\$0.00	0.0%	0.00

System Cost per Watt: \$4.13

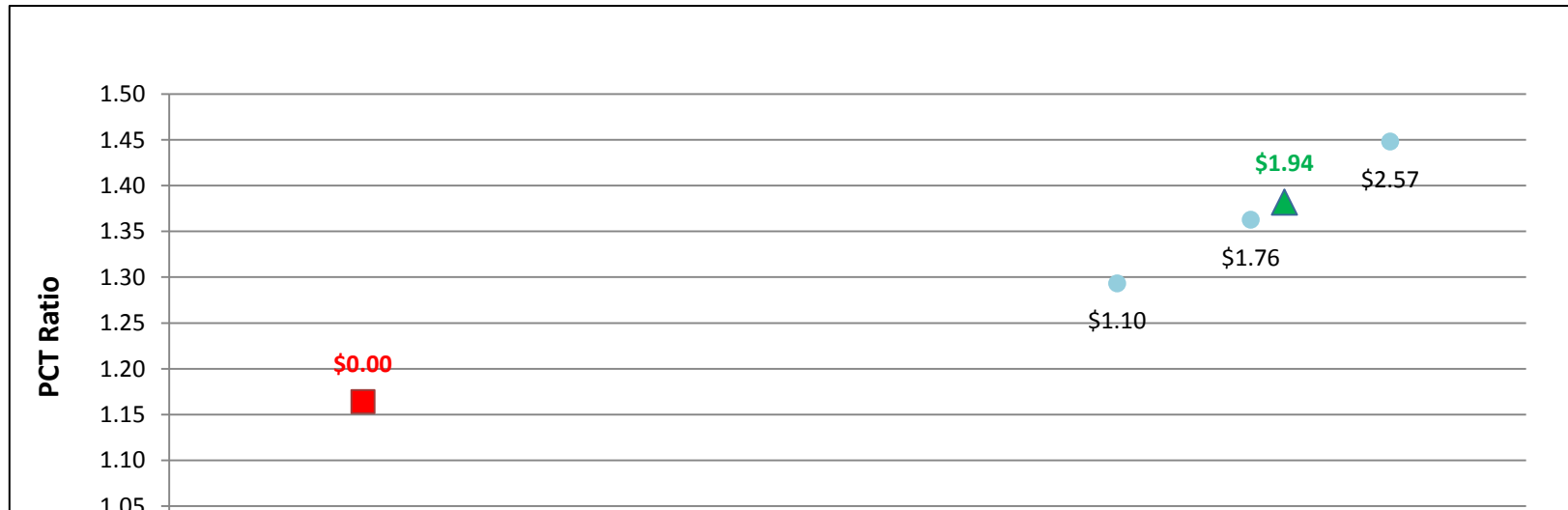


SGIP Cost Effectiveness Report
Participant Test Results (PCT)
MIRR Graphs

MT200kW w/ On-Site BioGas - Government/Non-Profit - SCE

	Rebate (\$/watt)	MIRR	PCT-2014
▲ Actual Rebate - 2014	\$1.94	14.2%	1.38
■ No Rebate	\$0.00	7.4%	1.16
● Rebate to Reach MIRR of 5%	\$0.00	0.0%	0.00
● Rebate to Reach MIRR of 6%	\$0.00	0.0%	0.00
● Rebate to Reach MIRR of 7%	\$0.00	0.0%	0.00
● Rebate to Reach MIRR of 8%	\$0.00	0.0%	0.00
● Rebate to Reach MIRR of 9%	\$0.00	0.0%	0.00
● Rebate to Reach MIRR of 10%	\$0.00	0.0%	0.00
● Rebate to Reach MIRR of 11%	\$0.00	0.0%	0.00
● Rebate to Reach MIRR of 12%	\$0.00	0.0%	0.00
● Rebate to Reach MIRR of 13%	\$1.10	13.0%	1.29
● Rebate to Reach MIRR of 14%	\$1.76	14.0%	1.36
● Rebate to Reach MIRR of 15%	\$2.57	15.0%	1.45

System Cost per Watt: \$4.13



SGIP Cost Effectiveness Report
Participant Test Results (PCT)
MIRR Graphs

MT200kW w/ On-Site BioGas - Government/Non-Profit - SDG&E

	Rebate (\$/watt)	MIRR	PCT-2014
▲ Actual Rebate - 2014	\$1.94	17.5%	1.70
■ No Rebate	\$0.00	11.1%	1.49
● Rebate to Reach MIRR of 5%	\$0.00	0.0%	0.00
● Rebate to Reach MIRR of 6%	\$0.00	0.0%	0.00
● Rebate to Reach MIRR of 7%	\$0.00	0.0%	0.00
● Rebate to Reach MIRR of 8%	\$0.00	0.0%	0.00
● Rebate to Reach MIRR of 9%	\$0.00	0.0%	0.00
● Rebate to Reach MIRR of 10%	\$0.00	0.0%	0.00
● Rebate to Reach MIRR of 11%	\$0.00	0.0%	0.00
● Rebate to Reach MIRR of 12%	\$0.00	0.0%	0.00
● Rebate to Reach MIRR of 13%	\$0.00	0.0%	0.00
● Rebate to Reach MIRR of 14%	\$0.00	0.0%	0.00
● Rebate to Reach MIRR of 15%	\$0.00	0.0%	0.00

System Cost per Watt: \$4.13



SGIP Cost Effectiveness Report
 Participant Test Results (PCT)
 MIRR Graphs

MT200kW w/ Directed BioGas - Commercial - PG&E

	Rebate (\$/watt)	MIRR	PCT-2014
▲ Actual Rebate - 2014	\$1.94	-3.1%	0.76
■ No Rebate	\$0.00	-7.7%	0.71
● Rebate to Reach MIRR of 5%	\$0.00	0.0%	0.00
● Rebate to Reach MIRR of 6%	\$0.00	0.0%	0.00
● Rebate to Reach MIRR of 7%	\$0.00	0.0%	0.00
● Rebate to Reach MIRR of 8%	\$0.00	0.0%	0.00
● Rebate to Reach MIRR of 9%	\$0.00	0.0%	0.00
● Rebate to Reach MIRR of 10%	\$0.00	0.0%	0.00
● Rebate to Reach MIRR of 11%	\$0.00	0.0%	0.00
● Rebate to Reach MIRR of 12%	\$0.00	0.0%	0.00
● Rebate to Reach MIRR of 13%	\$0.00	0.0%	0.00
● Rebate to Reach MIRR of 14%	\$0.00	0.0%	0.00
● Rebate to Reach MIRR of 15%	\$0.00	0.0%	0.00

System Cost per Watt: \$3.14



SGIP Cost Effectiveness Report
Participant Test Results (PCT)
MIRR Graphs

MT200kW w/ Directed BioGas - Commercial - SCE

	Rebate (\$/watt)	MIRR	PCT-2014
▲ Actual Rebate - 2014	\$1.94	-12.7%	0.67
■ No Rebate	\$0.00	-100.0%	0.62
● Rebate to Reach MIRR of 5%	\$0.00	0.0%	0.00
● Rebate to Reach MIRR of 6%	\$0.00	0.0%	0.00
● Rebate to Reach MIRR of 7%	\$0.00	0.0%	0.00
● Rebate to Reach MIRR of 8%	\$0.00	0.0%	0.00
● Rebate to Reach MIRR of 9%	\$0.00	0.0%	0.00
● Rebate to Reach MIRR of 10%	\$0.00	0.0%	0.00
● Rebate to Reach MIRR of 11%	\$0.00	0.0%	0.00
● Rebate to Reach MIRR of 12%	\$0.00	0.0%	0.00
● Rebate to Reach MIRR of 13%	\$0.00	0.0%	0.00
● Rebate to Reach MIRR of 14%	\$0.00	0.0%	0.00
● Rebate to Reach MIRR of 15%	\$0.00	0.0%	0.00

System Cost per Watt: \$3.14

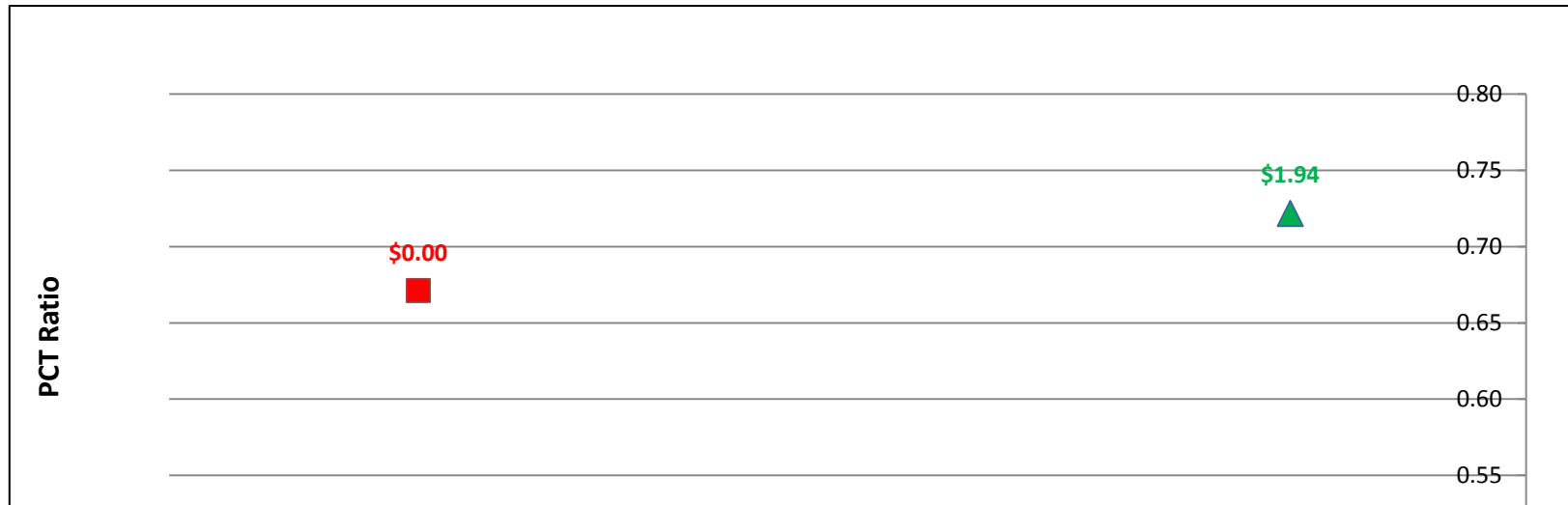


SGIP Cost Effectiveness Report
 Participant Test Results (PCT)
 MIRR Graphs

MT200kW w/ Directed BioGas - Commercial - SDG&E

	Rebate (\$/watt)	MIRR	PCT-2014
▲ Actual Rebate - 2014	\$1.94	-7.7%	0.72
■ No Rebate	\$0.00	-14.2%	0.67
● Rebate to Reach MIRR of 5%	\$0.00	0.0%	0.00
● Rebate to Reach MIRR of 6%	\$0.00	0.0%	0.00
● Rebate to Reach MIRR of 7%	\$0.00	0.0%	0.00
● Rebate to Reach MIRR of 8%	\$0.00	0.0%	0.00
● Rebate to Reach MIRR of 9%	\$0.00	0.0%	0.00
● Rebate to Reach MIRR of 10%	\$0.00	0.0%	0.00
● Rebate to Reach MIRR of 11%	\$0.00	0.0%	0.00
● Rebate to Reach MIRR of 12%	\$0.00	0.0%	0.00
● Rebate to Reach MIRR of 13%	\$0.00	0.0%	0.00
● Rebate to Reach MIRR of 14%	\$0.00	0.0%	0.00
● Rebate to Reach MIRR of 15%	\$0.00	0.0%	0.00

System Cost per Watt: \$3.14

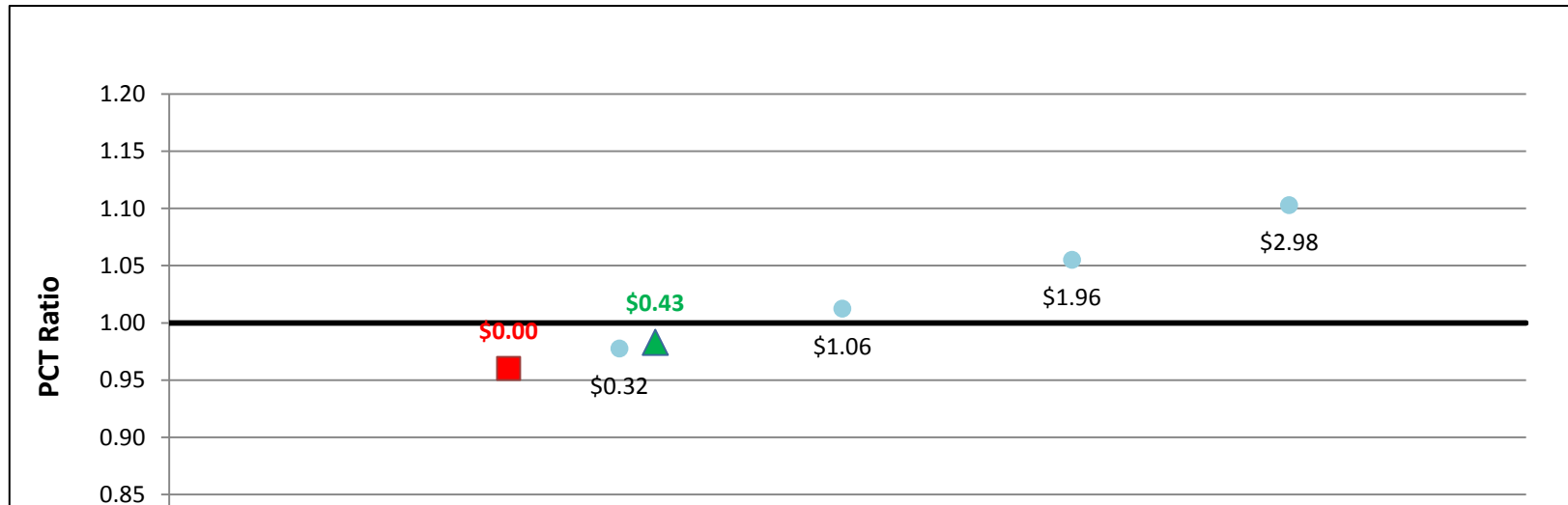


SGIP Cost Effectiveness Report
Participant Test Results (PCT)
MIRR Graphs

MT200kW w/ Natural Gas - Commercial - PG&E

	Rebate (\$/watt)	MIRR	PCT-2014
▲ Actual Rebate - 2014	\$0.43	10.1%	0.98
■ No Rebate	\$0.00	9.5%	0.96
● Rebate to Reach MIRR of 5%	\$0.00	0.0%	0.00
● Rebate to Reach MIRR of 6%	\$0.00	0.0%	0.00
● Rebate to Reach MIRR of 7%	\$0.00	0.0%	0.00
● Rebate to Reach MIRR of 8%	\$0.00	0.0%	0.00
● Rebate to Reach MIRR of 9%	\$0.00	0.0%	0.00
● Rebate to Reach MIRR of 10%	\$0.32	10.0%	0.98
● Rebate to Reach MIRR of 11%	\$1.06	11.0%	1.01
● Rebate to Reach MIRR of 12%	\$1.96	12.0%	1.06
● Rebate to Reach MIRR of 13%	\$2.98	13.0%	1.10
● Rebate to Reach MIRR of 14%	\$0.00	0.0%	0.00
● Rebate to Reach MIRR of 15%	\$0.00	0.0%	0.00

System Cost per Watt: \$3.14

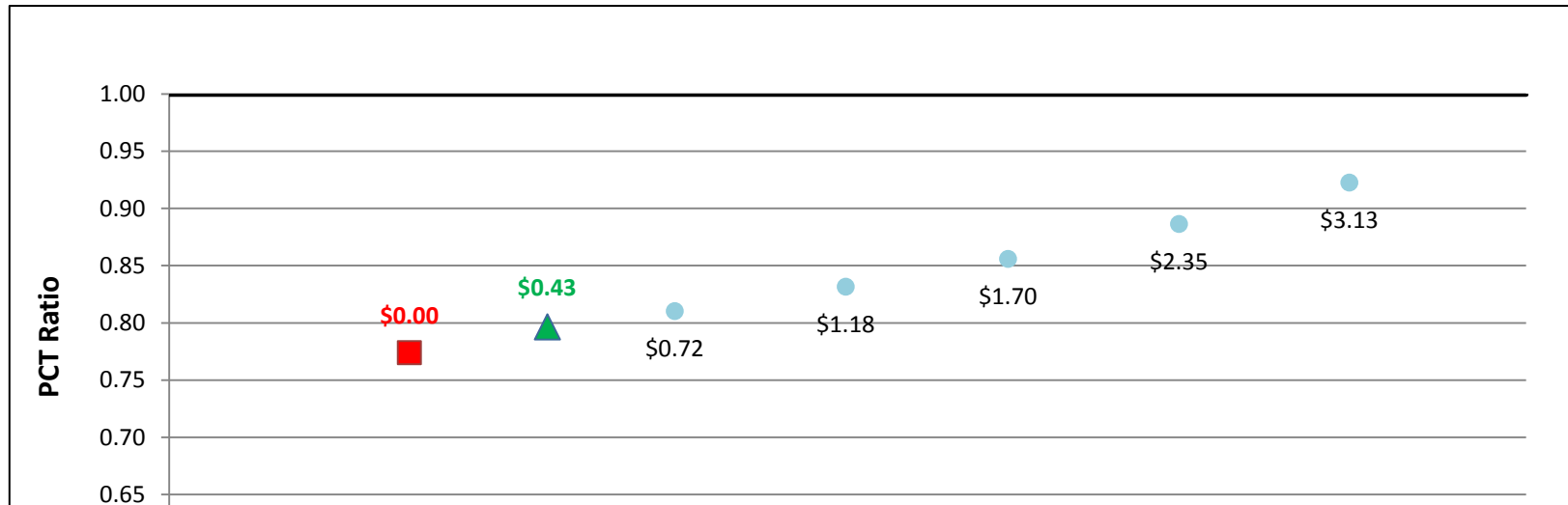


SGIP Cost Effectiveness Report
Participant Test Results (PCT)
MIRR Graphs

MT200kW w/ Natural Gas - Commercial - SCE

	Rebate (\$/watt)	MIRR	PCT-2014
▲ Actual Rebate - 2014	\$0.43	4.2%	0.80
■ No Rebate	\$0.00	3.4%	0.77
● Rebate to Reach MIRR of 5%	\$0.72	5.0%	0.81
● Rebate to Reach MIRR of 6%	\$1.18	6.0%	0.83
● Rebate to Reach MIRR of 7%	\$1.70	6.9%	0.86
● Rebate to Reach MIRR of 8%	\$2.35	8.0%	0.89
● Rebate to Reach MIRR of 9%	\$3.13	9.0%	0.92
● Rebate to Reach MIRR of 10%	\$0.00	0.0%	0.00
● Rebate to Reach MIRR of 11%	\$0.00	0.0%	0.00
● Rebate to Reach MIRR of 12%	\$0.00	0.0%	0.00
● Rebate to Reach MIRR of 13%	\$0.00	0.0%	0.00
● Rebate to Reach MIRR of 14%	\$0.00	0.0%	0.00
● Rebate to Reach MIRR of 15%	\$0.00	0.0%	0.00

System Cost per Watt: \$3.14

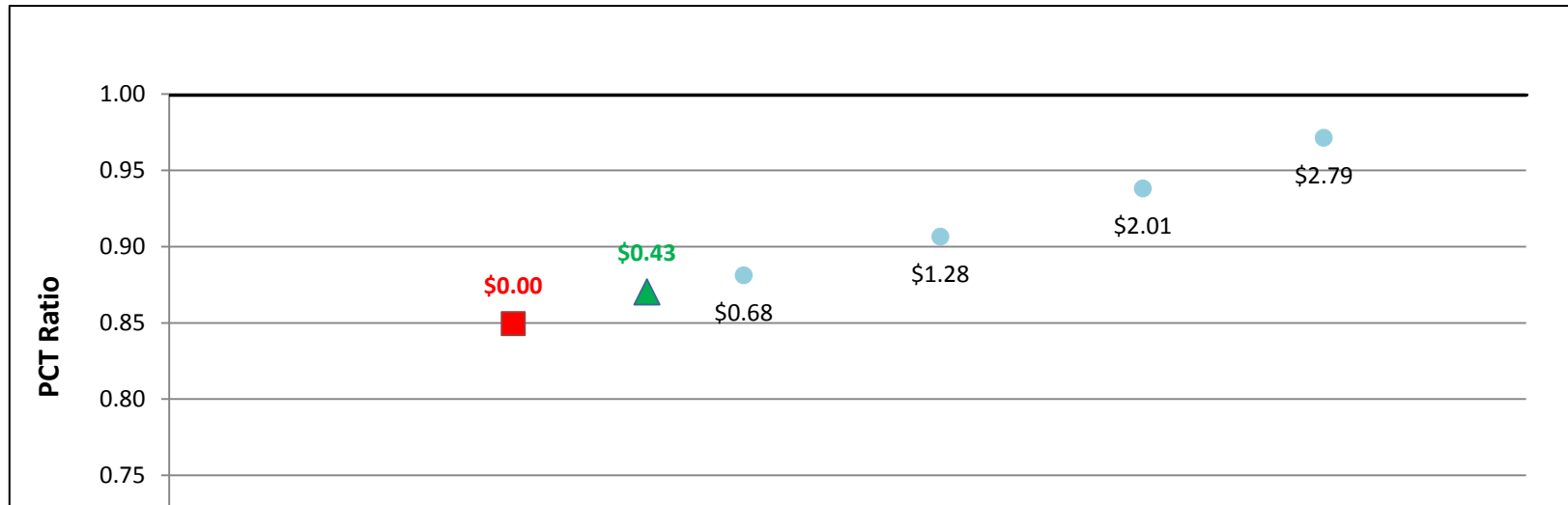


SGIP Cost Effectiveness Report
 Participant Test Results (PCT)
 MIRR Graphs

MT200kW w/ Natural Gas - Commercial - SDG&E

	Rebate (\$/watt)	MIRR	PCT-2014
▲ Actual Rebate - 2014	\$0.43	6.5%	0.87
■ No Rebate	\$0.00	5.8%	0.85
● Rebate to Reach MIRR of 5%	\$0.00	0.0%	0.00
● Rebate to Reach MIRR of 6%	\$0.00	0.0%	0.00
● Rebate to Reach MIRR of 7%	\$0.68	7.0%	0.88
● Rebate to Reach MIRR of 8%	\$1.28	8.0%	0.91
● Rebate to Reach MIRR of 9%	\$2.01	9.0%	0.94
● Rebate to Reach MIRR of 10%	\$2.79	10.0%	0.97
● Rebate to Reach MIRR of 11%	\$0.00	0.0%	0.00
● Rebate to Reach MIRR of 12%	\$0.00	0.0%	0.00
● Rebate to Reach MIRR of 13%	\$0.00	0.0%	0.00
● Rebate to Reach MIRR of 14%	\$0.00	0.0%	0.00
● Rebate to Reach MIRR of 15%	\$0.00	0.0%	0.00

System Cost per Watt: \$3.14

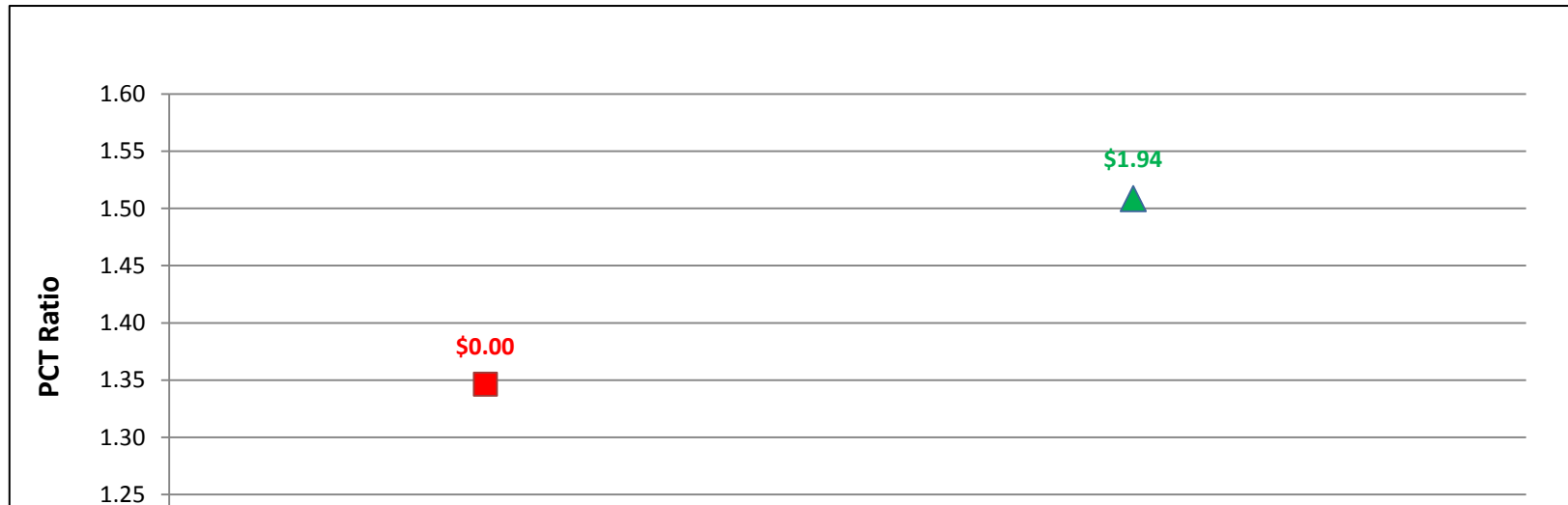


SGIP Cost Effectiveness Report
Participant Test Results (PCT)
MIRR Graphs

MT200kW w/ On-Site BioGas - Commercial - PG&E

	Rebate (\$/watt)	MIRR	PCT-2014
▲ Actual Rebate - 2014	\$1.94	16.6%	1.51
■ No Rebate	\$0.00	14.2%	1.35
● Rebate to Reach MIRR of 5%	\$0.00	0.0%	0.00
● Rebate to Reach MIRR of 6%	\$0.00	0.0%	0.00
● Rebate to Reach MIRR of 7%	\$0.00	0.0%	0.00
● Rebate to Reach MIRR of 8%	\$0.00	0.0%	0.00
● Rebate to Reach MIRR of 9%	\$0.00	0.0%	0.00
● Rebate to Reach MIRR of 10%	\$0.00	0.0%	0.00
● Rebate to Reach MIRR of 11%	\$0.00	0.0%	0.00
● Rebate to Reach MIRR of 12%	\$0.00	0.0%	0.00
● Rebate to Reach MIRR of 13%	\$0.00	0.0%	0.00
● Rebate to Reach MIRR of 14%	\$0.00	0.0%	0.00
● Rebate to Reach MIRR of 15%	\$0.00	0.0%	0.00

System Cost per Watt: \$4.13

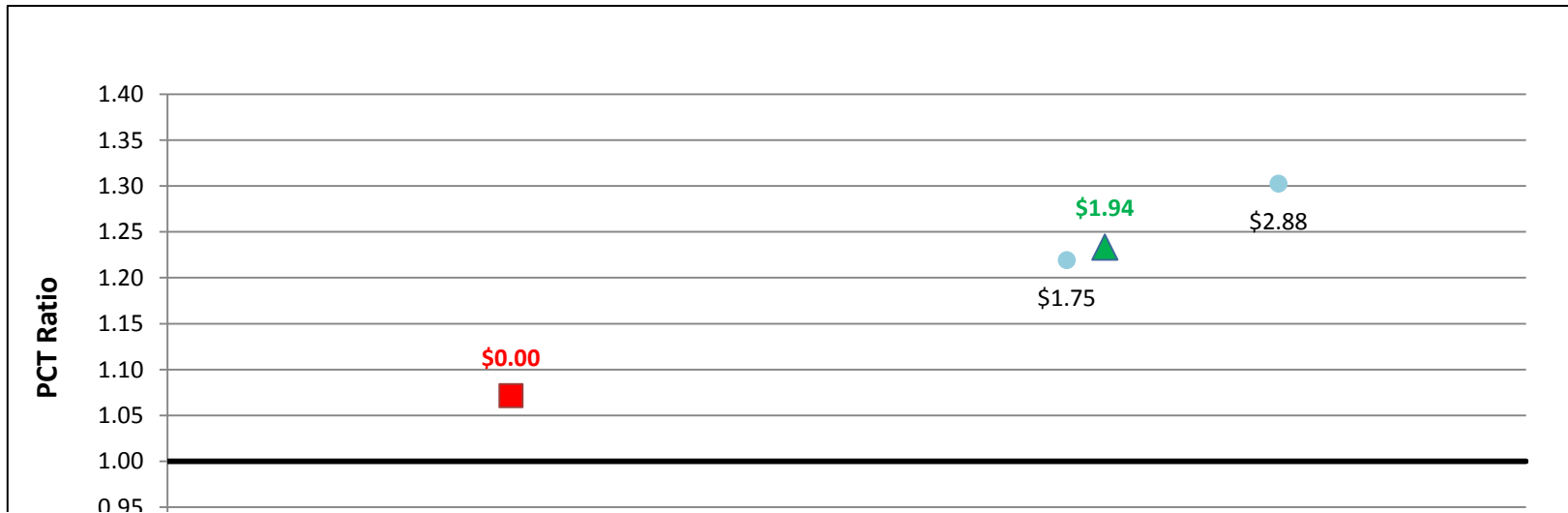


SGIP Cost Effectiveness Report
Participant Test Results (PCT)
MIRR Graphs

MT200kW w/ On-Site BioGas - Commercial - SCE

	Rebate (\$/watt)	MIRR	PCT-2014
▲ Actual Rebate - 2014	\$1.94	14.1%	1.23
■ No Rebate	\$0.00	11.5%	1.07
● Rebate to Reach MIRR of 5%	\$0.00	0.0%	0.00
● Rebate to Reach MIRR of 6%	\$0.00	0.0%	0.00
● Rebate to Reach MIRR of 7%	\$0.00	0.0%	0.00
● Rebate to Reach MIRR of 8%	\$0.00	0.0%	0.00
● Rebate to Reach MIRR of 9%	\$0.00	0.0%	0.00
● Rebate to Reach MIRR of 10%	\$0.00	0.0%	0.00
● Rebate to Reach MIRR of 11%	\$0.00	0.0%	0.00
● Rebate to Reach MIRR of 12%	\$0.00	0.0%	0.00
● Rebate to Reach MIRR of 13%	\$0.00	0.0%	0.00
● Rebate to Reach MIRR of 14%	\$1.75	14.0%	1.22
● Rebate to Reach MIRR of 15%	\$2.88	14.9%	1.30

System Cost per Watt: \$4.13

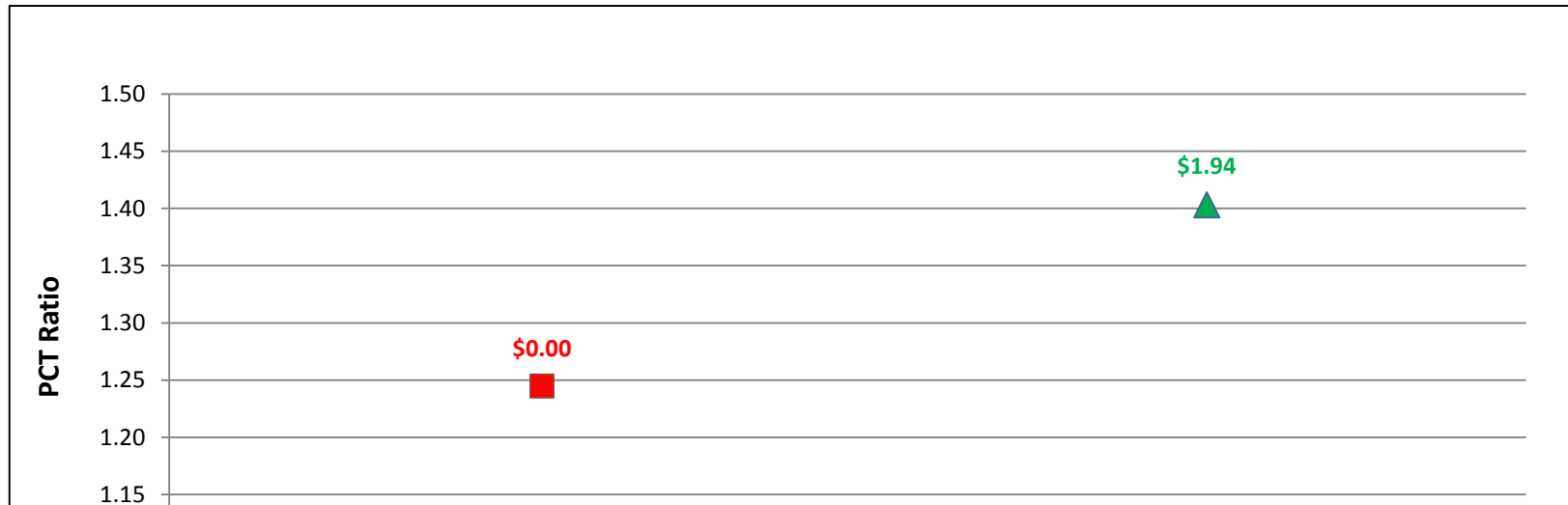


SGIP Cost Effectiveness Report
Participant Test Results (PCT)
MIRR Graphs

MT200kW w/ On-Site BioGas - Commercial - SDG&E

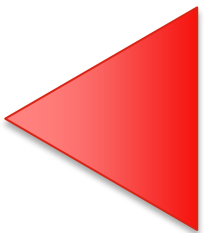
	Rebate (\$/watt)	MIRR	PCT-2014
▲ Actual Rebate - 2014	\$1.94	15.8%	1.40
■ No Rebate	\$0.00	13.4%	1.24
● Rebate to Reach MIRR of 5%	\$0.00	0.0%	0.00
● Rebate to Reach MIRR of 6%	\$0.00	0.0%	0.00
● Rebate to Reach MIRR of 7%	\$0.00	0.0%	0.00
● Rebate to Reach MIRR of 8%	\$0.00	0.0%	0.00
● Rebate to Reach MIRR of 9%	\$0.00	0.0%	0.00
● Rebate to Reach MIRR of 10%	\$0.00	0.0%	0.00
● Rebate to Reach MIRR of 11%	\$0.00	0.0%	0.00
● Rebate to Reach MIRR of 12%	\$0.00	0.0%	0.00
● Rebate to Reach MIRR of 13%	\$0.00	0.0%	0.00
● Rebate to Reach MIRR of 14%	\$0.00	0.0%	0.00
● Rebate to Reach MIRR of 15%	\$0.00	0.0%	0.00

System Cost per Watt: \$4.13





Wind



SGIP Cost Effectiveness Report
Participant Test Results (PCT)
MIRR Graphs

WD1500kW - Government/Non-Profit - PG&E

	Rebate (\$/watt)	MIRR	PCT-2014
▲ Actual Rebate - 2014	\$0.37	11.5%	1.46
■ No Rebate	\$0.00	10.1%	1.39
● Rebate to Reach MIRR of 5%	\$0.00	0.0%	0.00
● Rebate to Reach MIRR of 6%	\$0.00	0.0%	0.00
● Rebate to Reach MIRR of 7%	\$0.00	0.0%	0.00
● Rebate to Reach MIRR of 8%	\$0.00	0.0%	0.00
● Rebate to Reach MIRR of 9%	\$0.00	0.0%	0.00
● Rebate to Reach MIRR of 10%	\$0.00	0.0%	0.00
● Rebate to Reach MIRR of 11%	\$0.00	0.0%	0.00
● Rebate to Reach MIRR of 12%	\$0.69	12.0%	1.52
● Rebate to Reach MIRR of 13%	\$1.41	13.0%	1.65
● Rebate to Reach MIRR of 14%	\$0.00	0.0%	0.00
● Rebate to Reach MIRR of 15%	\$0.00	0.0%	0.00

System Cost per Watt: \$2.27

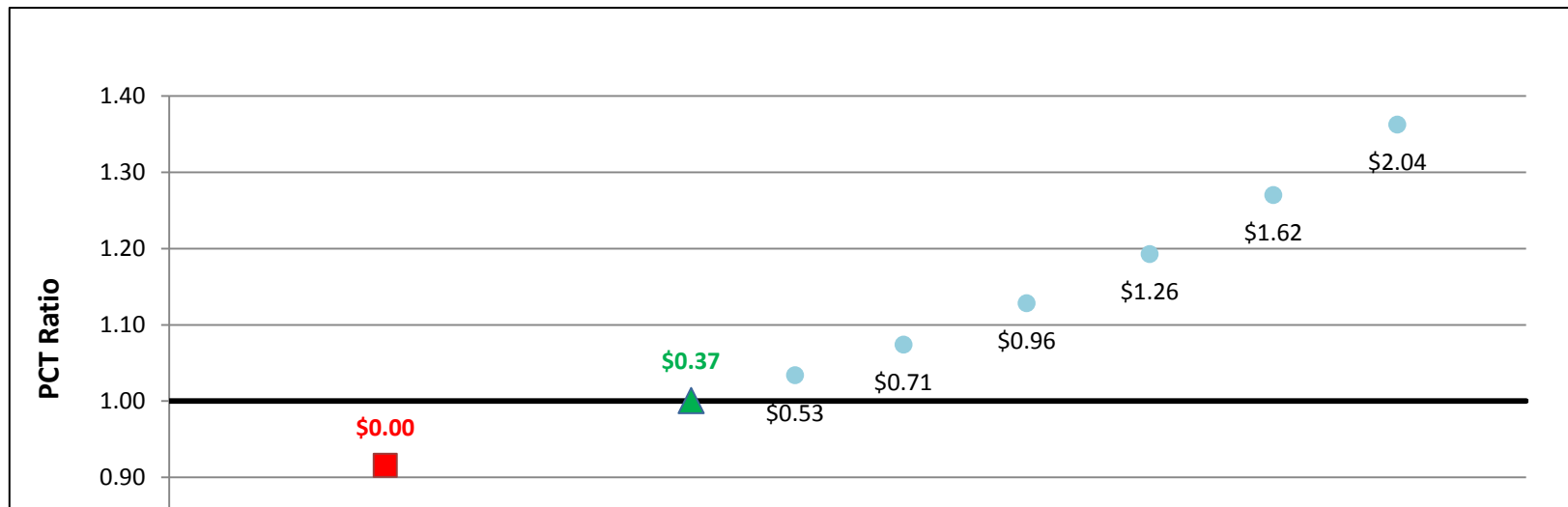


SGIP Cost Effectiveness Report
Participant Test Results (PCT)
MIRR Graphs

WD1500kW - Government/Non-Profit - SCE

	Rebate (\$/watt)	MIRR	PCT-2014
▲ Actual Rebate - 2014	\$0.37	4.2%	1.00
■ No Rebate	\$0.00	1.8%	0.92
● Rebate to Reach MIRR of 5%	\$0.53	5.1%	1.03
● Rebate to Reach MIRR of 6%	\$0.71	6.0%	1.07
● Rebate to Reach MIRR of 7%	\$0.96	7.0%	1.13
● Rebate to Reach MIRR of 8%	\$1.26	7.9%	1.19
● Rebate to Reach MIRR of 9%	\$1.62	9.0%	1.27
● Rebate to Reach MIRR of 10%	\$2.04	10.0%	1.36
● Rebate to Reach MIRR of 11%	\$0.00	0.0%	0.00
● Rebate to Reach MIRR of 12%	\$0.00	0.0%	0.00
● Rebate to Reach MIRR of 13%	\$0.00	0.0%	0.00
● Rebate to Reach MIRR of 14%	\$0.00	0.0%	0.00
● Rebate to Reach MIRR of 15%	\$0.00	0.0%	0.00

System Cost per Watt: \$2.27



SGIP Cost Effectiveness Report
Participant Test Results (PCT)
MIRR Graphs

WD1500kW - Government/Non-Profit - SDG&E

	Rebate (\$/watt)	MIRR	PCT-2014
▲ Actual Rebate - 2014	\$0.37	9.0%	1.25
■ No Rebate	\$0.00	7.4%	1.17
● Rebate to Reach MIRR of 5%	\$0.00	0.0%	0.00
● Rebate to Reach MIRR of 6%	\$0.00	0.0%	0.00
● Rebate to Reach MIRR of 7%	\$0.00	0.0%	0.00
● Rebate to Reach MIRR of 8%	\$0.00	0.0%	0.00
● Rebate to Reach MIRR of 9%	\$0.37	9.0%	1.25
● Rebate to Reach MIRR of 10%	\$0.81	10.0%	1.34
● Rebate to Reach MIRR of 11%	\$1.34	11.0%	1.45
● Rebate to Reach MIRR of 12%	\$1.89	11.9%	1.56
● Rebate to Reach MIRR of 13%	\$0.00	0.0%	0.00
● Rebate to Reach MIRR of 14%	\$0.00	0.0%	0.00
● Rebate to Reach MIRR of 15%	\$0.00	0.0%	0.00

System Cost per Watt: \$2.27

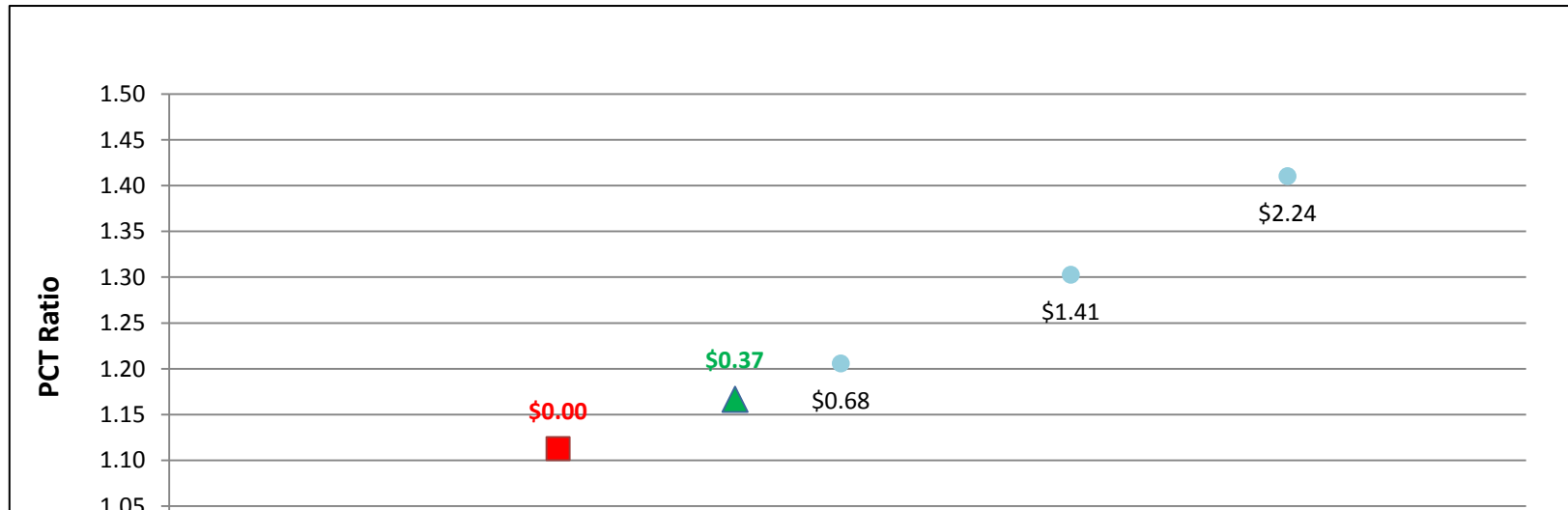


SGIP Cost Effectiveness Report
Participant Test Results (PCT)
MIRR Graphs

WD1500kW - Commercial - PG&E

	Rebate (\$/watt)	MIRR	PCT-2014
▲ Actual Rebate - 2014	\$0.37	12.5%	1.17
■ No Rebate	\$0.00	11.7%	1.11
● Rebate to Reach MIRR of 5%	\$0.00	0.0%	0.00
● Rebate to Reach MIRR of 6%	\$0.00	0.0%	0.00
● Rebate to Reach MIRR of 7%	\$0.00	0.0%	0.00
● Rebate to Reach MIRR of 8%	\$0.00	0.0%	0.00
● Rebate to Reach MIRR of 9%	\$0.00	0.0%	0.00
● Rebate to Reach MIRR of 10%	\$0.00	0.0%	0.00
● Rebate to Reach MIRR of 11%	\$0.00	0.0%	0.00
● Rebate to Reach MIRR of 12%	\$0.00	0.0%	0.00
● Rebate to Reach MIRR of 13%	\$0.68	13.0%	1.21
● Rebate to Reach MIRR of 14%	\$1.41	14.0%	1.30
● Rebate to Reach MIRR of 15%	\$2.24	14.9%	1.41

System Cost per Watt: \$2.27

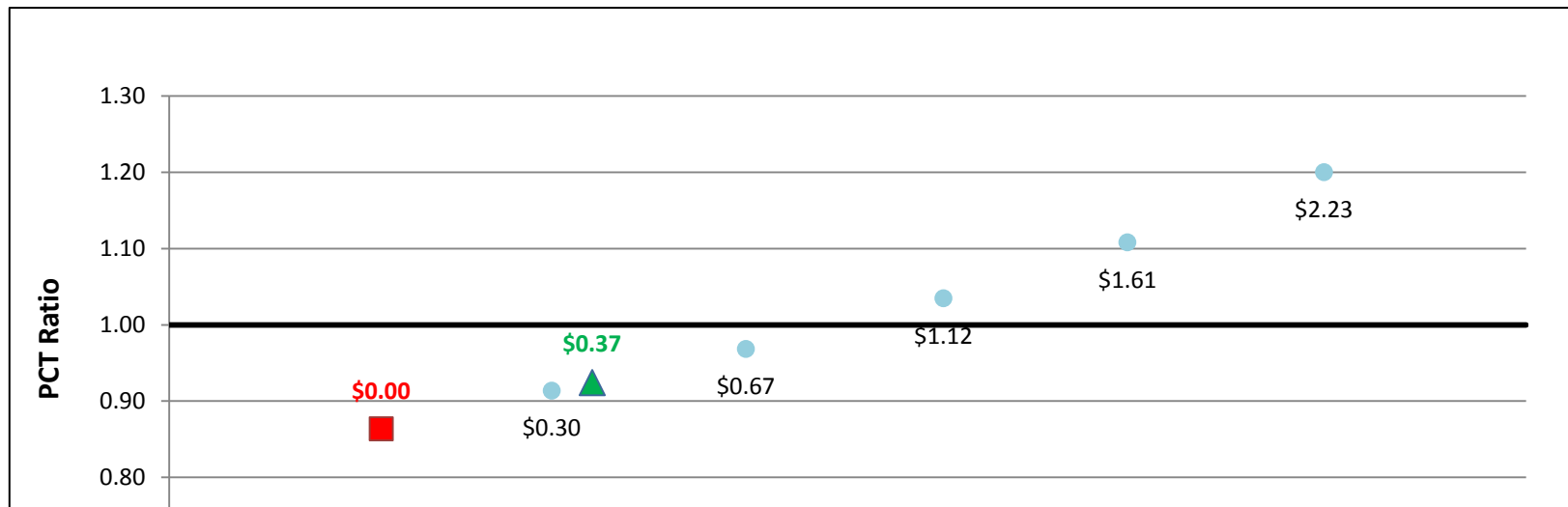


SGIP Cost Effectiveness Report
 Participant Test Results (PCT)
 MIRR Graphs

WD1500kW - Commercial - SCE

	Rebate (\$/watt)	MIRR	PCT-2014
▲ Actual Rebate - 2014	\$0.37	9.2%	0.92
■ No Rebate	\$0.00	8.1%	0.86
● Rebate to Reach MIRR of 5%	\$0.00	0.0%	0.00
● Rebate to Reach MIRR of 6%	\$0.00	0.0%	0.00
● Rebate to Reach MIRR of 7%	\$0.00	0.0%	0.00
● Rebate to Reach MIRR of 8%	\$0.00	0.0%	0.00
● Rebate to Reach MIRR of 9%	\$0.30	9.0%	0.91
● Rebate to Reach MIRR of 10%	\$0.67	10.0%	0.97
● Rebate to Reach MIRR of 11%	\$1.12	11.0%	1.03
● Rebate to Reach MIRR of 12%	\$1.61	11.9%	1.11
● Rebate to Reach MIRR of 13%	\$2.23	13.0%	1.20
● Rebate to Reach MIRR of 14%	\$0.00	0.0%	0.00
● Rebate to Reach MIRR of 15%	\$0.00	0.0%	0.00

System Cost per Watt: \$2.27

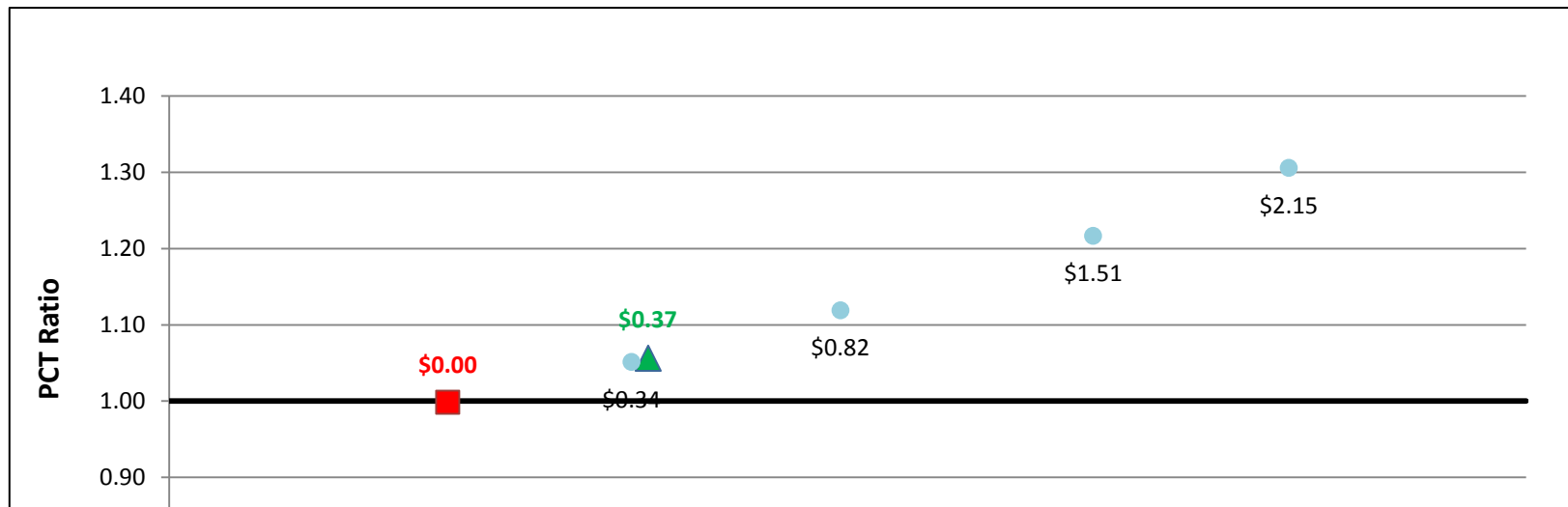


SGIP Cost Effectiveness Report
Participant Test Results (PCT)
MIRR Graphs

WD1500kW - Commercial - SDG&E

	Rebate (\$/watt)	MIRR	PCT-2014
▲ Actual Rebate - 2014	\$0.37	11.1%	1.06
■ No Rebate	\$0.00	10.2%	1.00
● Rebate to Reach MIRR of 5%	\$0.00	0.0%	0.00
● Rebate to Reach MIRR of 6%	\$0.00	0.0%	0.00
● Rebate to Reach MIRR of 7%	\$0.00	0.0%	0.00
● Rebate to Reach MIRR of 8%	\$0.00	0.0%	0.00
● Rebate to Reach MIRR of 9%	\$0.00	0.0%	0.00
● Rebate to Reach MIRR of 10%	\$0.00	0.0%	0.00
● Rebate to Reach MIRR of 11%	\$0.34	11.0%	1.05
● Rebate to Reach MIRR of 12%	\$0.82	12.0%	1.12
● Rebate to Reach MIRR of 13%	\$1.51	13.1%	1.22
● Rebate to Reach MIRR of 14%	\$2.15	14.0%	1.31
● Rebate to Reach MIRR of 15%	\$0.00	0.0%	0.00

System Cost per Watt: \$2.27

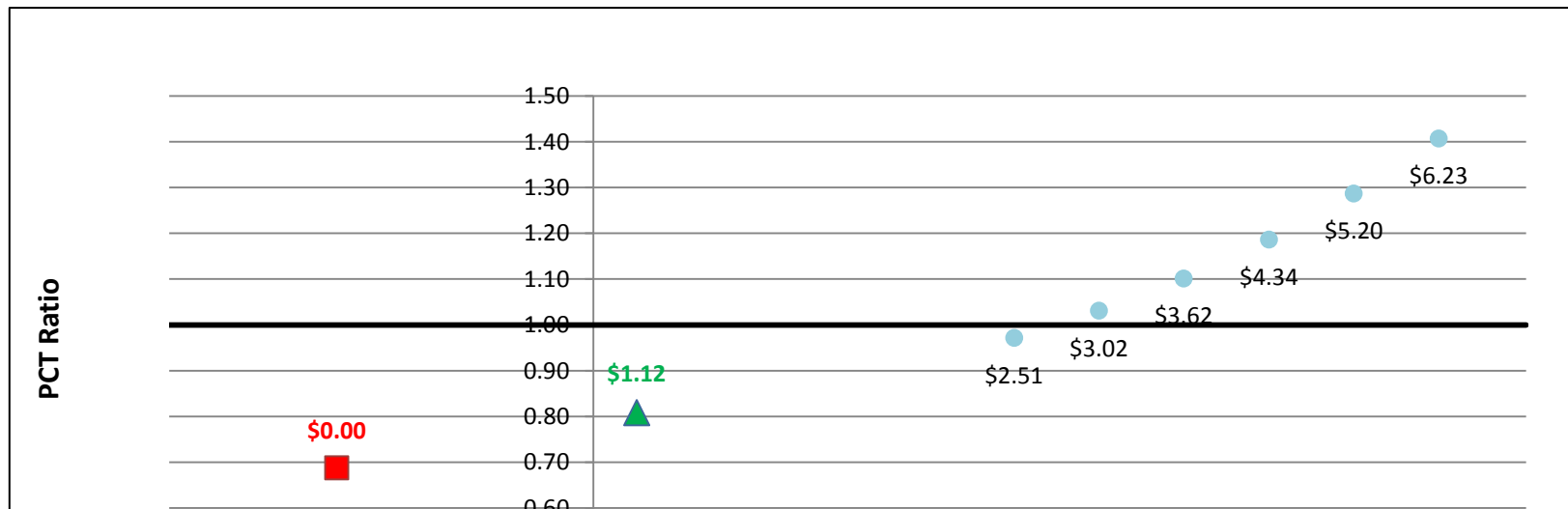


SGIP Cost Effectiveness Report
Participant Test Results (PCT)
MIRR Graphs

WD50kW - Residential - PG&E

	Rebate (\$/watt)	MIRR	PCT-2014
▲ Actual Rebate - 2014	\$1.12	0.5%	0.81
■ No Rebate	\$0.00	-3.0%	0.69
● Rebate to Reach MIRR of 5%	\$2.51	5.0%	0.97
● Rebate to Reach MIRR of 6%	\$3.02	6.0%	1.03
● Rebate to Reach MIRR of 7%	\$3.62	7.0%	1.10
● Rebate to Reach MIRR of 8%	\$4.34	8.0%	1.19
● Rebate to Reach MIRR of 9%	\$5.20	9.0%	1.29
● Rebate to Reach MIRR of 10%	\$6.23	10.0%	1.41
● Rebate to Reach MIRR of 11%	\$0.00	0.0%	0.00
● Rebate to Reach MIRR of 12%	\$0.00	0.0%	0.00
● Rebate to Reach MIRR of 13%	\$0.00	0.0%	0.00
● Rebate to Reach MIRR of 14%	\$0.00	0.0%	0.00
● Rebate to Reach MIRR of 15%	\$0.00	0.0%	0.00

System Cost per Watt: \$6.41

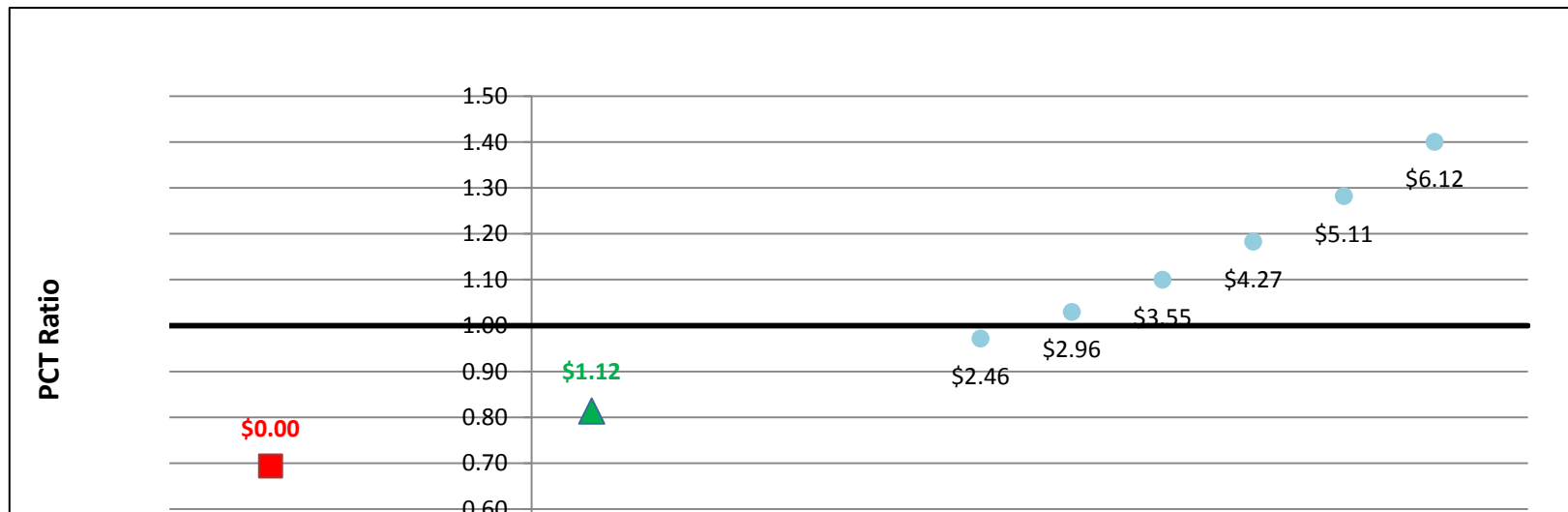


SGIP Cost Effectiveness Report
Participant Test Results (PCT)
MIRR Graphs

WD50kW - Residential - SCE

	Rebate (\$/watt)	MIRR	PCT-2014
▲ Actual Rebate - 2014	\$1.12	0.7%	0.81
■ No Rebate	\$0.00	-2.9%	0.69
● Rebate to Reach MIRR of 5%	\$2.46	5.0%	0.97
● Rebate to Reach MIRR of 6%	\$2.96	6.0%	1.03
● Rebate to Reach MIRR of 7%	\$3.55	7.0%	1.10
● Rebate to Reach MIRR of 8%	\$4.27	8.0%	1.18
● Rebate to Reach MIRR of 9%	\$5.11	9.0%	1.28
● Rebate to Reach MIRR of 10%	\$6.12	10.0%	1.40
● Rebate to Reach MIRR of 11%	\$0.00	0.0%	0.00
● Rebate to Reach MIRR of 12%	\$0.00	0.0%	0.00
● Rebate to Reach MIRR of 13%	\$0.00	0.0%	0.00
● Rebate to Reach MIRR of 14%	\$0.00	0.0%	0.00
● Rebate to Reach MIRR of 15%	\$0.00	0.0%	0.00

System Cost per Watt: \$6.41



SGIP Cost Effectiveness Report
Participant Test Results (PCT)
MIRR Graphs

WD50kW - Residential - SDG&E

	Rebate (\$/watt)	MIRR	PCT-2014
▲ Actual Rebate - 2014	\$1.12	1.1%	0.83
■ No Rebate	\$0.00	-2.6%	0.71
● Rebate to Reach MIRR of 5%	\$2.34	5.0%	0.97
● Rebate to Reach MIRR of 6%	\$2.83	6.0%	1.03
● Rebate to Reach MIRR of 7%	\$3.41	7.0%	1.10
● Rebate to Reach MIRR of 8%	\$4.10	8.0%	1.18
● Rebate to Reach MIRR of 9%	\$4.93	9.0%	1.27
● Rebate to Reach MIRR of 10%	\$5.92	10.0%	1.39
● Rebate to Reach MIRR of 11%	\$0.00	0.0%	0.00
● Rebate to Reach MIRR of 12%	\$0.00	0.0%	0.00
● Rebate to Reach MIRR of 13%	\$0.00	0.0%	0.00
● Rebate to Reach MIRR of 14%	\$0.00	0.0%	0.00
● Rebate to Reach MIRR of 15%	\$0.00	0.0%	0.00

System Cost per Watt: \$6.41



APPENDIX D SGIPCE USER GUIDE

This SGIPce User Guide is designed to be an in-depth look at how to use the SGIP cost effectiveness model. The SGIPce model was designed to estimate the cost effectiveness of SGIP technologies over time. The model incorporates the assumption of market transformation, allowing the user to define the likely future path of the SGIP technology installation costs. It also allows the user to select various technologies of interest and calculate their cost effectiveness individually or as a group of technologies and store the results for review and further analysis.

The purpose of the User Guide is to present details about the components of the system. The User Guide documents the input workbooks, includes information about the calculation engine that controls the model runs, and provides a discussion of the results that are generated and stored by the system.

Section 1 provides an overview of the SGIPce model to acquaint users with the overall structure and components of the SGIPce model.

Section 2 is a Quick Start Guide to aid users in installing the model files and get the system up and running. This guide is also included as a stand-alone pdf document along with the SGIPce model. It provides instructions on how to install the system and how to setup Excel for the first use in running the model. These instructions must be followed for the system to operate correctly. After the Quick Start Guide, the user will find a more in-depth description of the different components of the system.

Section 3 provides information on how to make changes to the model in order to run scenarios.

Section 4 describes how to make manual changes to inputs.

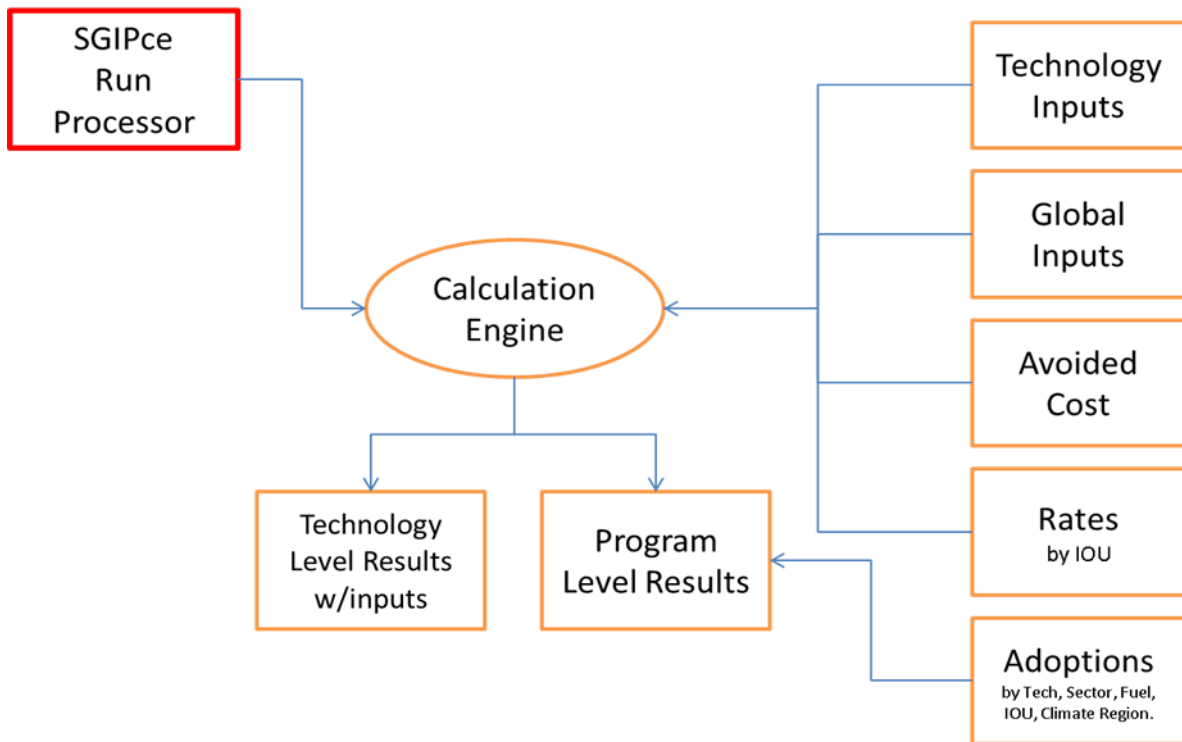
D.1 OVERVIEW OF THE SGIPce MODEL

The SGIPce model provides a publicly-available modeling tool that allows the CPUC, utilities, and distributed generation and storage stakeholders the ability to evaluate the cost effectiveness of SGIP technologies or a portfolio of these technologies (i.e., the SGIP) currently and in the future.

This section is designed to give the user an overview of the model structure. The structure and components of the model are discussed in broad terms to help orient the user as to where things are in the system. A brief discussion of how the system runs is also presented to complete the overview. A more thorough discussion of these concepts will be presented in the following sections.

Structure of the Model

The general structure of the model can be seen in Figure D-1 below. Each box in this figure represents one or more Excel workbooks. Each workbook serves various needs required by the system. The boxes will be briefly described here and in more detail in the following sections of this document.

FIGURE D-1: STRUCTURE OF SGIPce MODEL


Run Processor

The first box found in Figure D-1 shows a box representing the SGIPce Run Processor. The SGIPce Run Processor is the controlling workbook for the system. It is where the user starts the system and where the batch runs are defined. Once a run is defined the user presses a processor button which calls routines in the Calculation Engine. Pressing the processor button starts the process of calculating the results as defined by the user.

Technology Inputs

This box represents a set of workbooks that define the inputs for all technologies available in the model. There is one workbook for each technology, size, sector, and type of fuel. In the case of the ORC, Storage, and Wind technologies the fuel type is not considered. These workbooks have a corresponding set of line items in the Run Processor allowing the user to specify other characteristics about them to more accurately define the desired run criteria.

The Technology Input workbooks define all aspects of the technology data necessary to run a technology in the system. The inputs include global technology level data (*Constants*) that do not change over time like system size, degradation, emissions, etc. The workbooks include annual inputs (*AnnualInputs*) that have a time component to them, such as system installation costs, rebates, and operating and maintenance costs. Also defined in the technology workbooks is the level of production



(*Technology Production & Production Curves*) expected from the system for each hour of the year (i.e., 8,760 hours per year).

The system retrieves the technology-level data from the Technology Input workbooks. There are, however, a number of supplementary worksheets in the technology workbooks. These worksheets should be considered as the working papers used by the engineers in developing the data for each technology. The supplemental tabs document the sources of data used and are referenced by the Technology Input worksheet.

Global Inputs

This box represents a workbook that contains data used by all technologies. Included in this workbook are data for various financing options having a time component; global inputs that are also time-dependent and global inputs that are not time-dependent. Examples of global inputs include utility and societal discount rates; inflation rate and operation and maintenance escalation rate; emission costs and electric price multipliers for GHG; and financial inputs such as federal and state tax rates.

Avoided Cost Workbooks

The avoided cost box represents four workbooks that contain the electric and gas avoided costs. The electric avoided costs are stored in a workbook that holds the values by utility and climate region (i.e., coastal and inland) and for the base case and high cost scenario of avoided cost. The high cost scenario is used in the calculation of the GHG scenario. The avoided costs are sets of 8,760 values that span the period from 2012 through 2040. Avoided cost values used in the model are derived from E3's 2013 NEM avoided cost calculator.¹ The model uses the 8760 hourly avoided cost values and the 8760 hourly technology production curves in calculating a stream of annual values that are then supplied to the calculation engine.

The gas avoided cost data are similar in nature to the electric avoided costs with the following differences. The gas avoided costs differ by sector and are aggregated to a monthly level. The gas avoided costs are developed by sector because the gas GHG emissions differ by the underlying technology (boiler vs furnace). The gas avoided costs are not provided at the 8760 level because gas consumption and heat usage is only monitored monthly; therefore, the avoided costs are supplied at that level. The gas avoided costs span the same period as the electric avoided costs. Two production curves are supplied to the workbook: natural gas (therms required) used to fuel the CHP DG technology and "therms saved" from capturing the waste heat from the CHP DG technology. As expected, two streams of values are calculated from these production curves and supplied back to the calculation engine, one for each production curve.

¹ From E3, draft 2015 version of revised 2013 NEM workbook.



A set of gas avoided costs were also developed using only the T&D components of the benefits. These values are needed for non-core customers when calculating the PAC tests.

Electric and Gas Rate Workbooks

The rates box in Figure D-1 represents a number of workbooks designed to supply utility rate information to the system. Rates are defined for the residential and non-residential sectors. Due to the complex nature of rates, the non-residential rates are defined in separate workbooks for each utility and selected rate. For the residential sector it was possible to combine all rate definitions into one workbook. There is also a third workbook that defines the gas rates for the non-residential sector. The non-residential gas rates workbook provides rates from non-core gas customers with a reduced T&D fee for CHP gas required to run the DG measures. This workbook also provides the rate information, with the standard T&D fee, for the valuation of the natural gas saved from capturing the heat generated by the CHP DG measure.

The structure of the rates workbooks is similar in nature to the avoided cost workbooks in that the electric workbooks are defined for 8,760 hours over the entire possible lifetime of the technologies. The technology production curve is supplied to the workbook and a stream of annual values is provided to the calculation engine. For the rates, however, there is a secondary set of worksheets that define the rates. These worksheets are used to calculate the vast number of values needed for the yearly calculation based on production. The structure of these workbooks will be discussed later.

It should be noted that due to the tremendous number of calculations the link between the secondary worksheets and the main worksheet for the non-residential rate was broken to help minimize the calculation time during the batch runs. A separate workbook with all calculations has been maintained in the event that changes are needed or new rates are desired for future runs.

Both the gas avoided cost workbook and the non-residential gas rates workbook are defined at the monthly level. The quantity of natural gas required to fuel the DG technology and the natural gas savings from heat capture are supplied to the workbook in monthly values. The rates workbook multiplies the gas needed and the gas saved by the appropriate rates and then provides the calculation engine with the value of the net increase in gas consumption.

The residential workbook contains both gas and electric rates in one workbook. The workbook contains two worksheets that aggregate the data needed by the system and uses the other supplementary worksheet to calculate the appropriate rates given the utility and rate defined by the user for the technology. For the residential rate it was possible to preserve the calculations without degrading the speed of the system.

Adoptions

The Adoptions box in the figure above represents a single workbook that supplies adoptions data to the results workbook upon completion of each batch run. Adoptions in this workbook have been defined for



every combination of SGIP technologies investigated in this study. The adoptions are defined annually and span from 2011 through 2024.

Calculation Engine

As mentioned earlier, each of the items in Figure D-1 represent workbooks. The calculation engine oval is no exception. This item represents the workbook that does all the calculation work in the model. Most of the workbooks just described are inputs to this workbook. The code that runs when the user starts the batch processor opens these input workbooks, copies their data, and pastes them into the calculation engine. Once this process is complete the calculation engine loops from 2011 through 2024 and generates all the data needed to calculate the cost effectiveness tests.

If the user so chooses, the technology-level results for each technology can be stored as a separate Calculation Engine workbook. These workbooks contain copies of all the inputs and all the calculated results for the technologies. The user can perform quality control on the individual technology-level workbooks to determine the accuracy of the calculations and the accuracy of the results they produced. This level of detail is invaluable for developing confidence in the output of the system.

D.2 SETTING UP THE MODEL (QUICK START GUIDE)

The Quick Start Guide is designed to get the user up and running quickly. Instructions are included on the following:

- » How and where to copy the workbooks
- » How to start the system
- » What can be changed to do a batch run
- » What buttons to push to start the batch run
- » Where output is stored
- » Where to view results

This section is designed to show the user how to get the system up and running. This guide is not designed to be a complete guide to manually changing inputs for various scenarios.

Installing the Model

Hardware and Software Requirements

To run the SGIPce software the computer must be running Microsoft Excel 2007 or later. As for hardware requirements, the system will utilize as much memory as the computer makes available to it and the amount of hard drive space will be determined by the number of runs the user chooses to make.



Installing the Workbooks

The SGIPce System is a collection of workbooks. The distribution media includes all files needed to run the system. The contents of the SGIPce directory must be copied from the distribution media onto the user's hard drive. Once copied, follow the instructions described below, to set up this directory as a Trusted Directory so that the SGIPce macros will run on the computer. When this is complete, you are ready to start the system. There are two things to note when copying the 2014 SGIPce model onto the user's system. First, if the original files are zipped, make sure to unzip the files and then copy the unzipped files into the new directory. Second, the new directory should not be nested too deeply into the root "C" directory. If the directory is nested too deeply, the path name becomes too long and the model may not run.

Trusted Security Settings

Excel has a security system that protects the user from undesirable access to their systems using Visual Basic (VBA). The following steps must be performed to allow VBA to work on the system.

- » Open Excel and press the Office button, top left
- » Press the Excel Options button, bottom right
- » Select Trust Center
- » Press the button called Trust Center Settings...
- » Select Trusted Locations
- » Make sure the Allow Trusted Locations... option is checked
- » Press Add New Location....
- » Browse to the path where SGIPce.exe is located and press Enter
- » Check the checkbox that says Subfolders of the location are also trusted
- » Press Ok
- » Press Ok
- » Press Ok
- » Reopen SGIPce.xlsm

With these settings changed, the system will be able to run the VBA batch processor.

Using the System

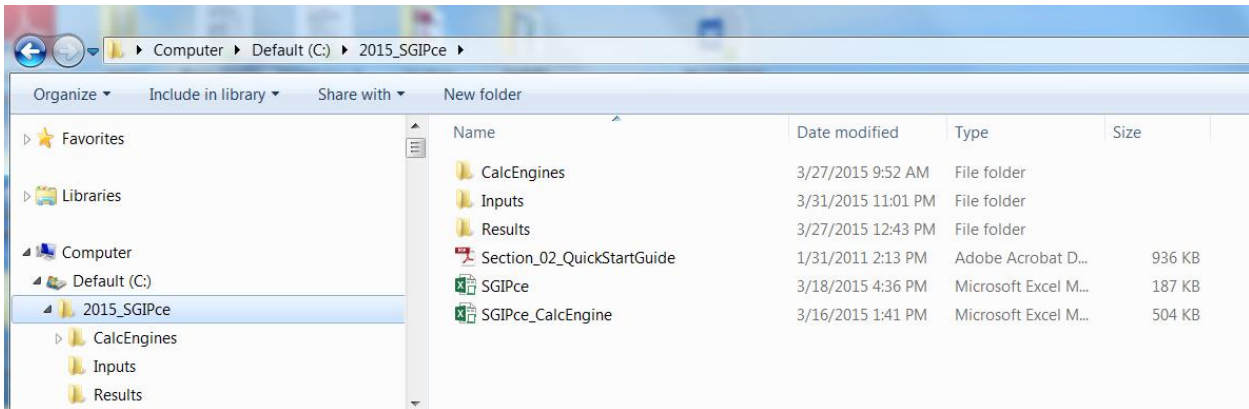
Introduction

The collection of workbooks that you have installed on your system includes SGIPce, the calculation engine, an inputs folder with the various input workbooks, and a results folder with a results template. This subsection will focus on the SCIPce file and using the file to run the SGIP cost effectiveness model.

Starting the System

The system is initiated when the user opens SGIPce.xlsm in Excel. This file can be found in the top-most directory on the drive where the directory was copied. An example of the directory can be found in Figure D-2. This workbook opens to the controlling worksheet of the system.

FIGURE D-2: SGIPce DIRECTORY STRUCTURE



An example of the SGIPce Control Worksheet is presented in Figure D-3. This worksheet is used to set up the technologies to be run, names the iteration being run, and starts the calculation engine to perform the batch run. This is the worksheet that the user must first set up to select the technologies, sector, fuel used, utility and utility rate, climate region, financing, and rebate type.

FIGURE D-3: SGIPce CONTROL WORKSHEET

SGIPce Program Scenario Simulator

Global Assumptions		Base Case	
Program Scenario Name		Version Description	GThe1MW_NG_Comm_PGE
Default Year	2014	Save Calc for each line?	Yes
Save Results by Utility?	No	Update/Replace Results?	No
Save MIRR	No		

Batch Process: No Screen Updating

Batch Process: View Screen Updating

Batch Process: Run Unattended

Set Run Tech Flag Off Read Progress Ratio Override

Set Run Tech Flag On Clear Filters

Technology Definitions													
Run Number	Run Flag	Technology Name	Sector	Fuel Type	Utility	Climate Region	Utility Rate	Financing Option	Rebate Type	Progress Ratio	Technology Scenario Description	Expected Capacity Factor	Error Condition
1	No	Gas Turbine (<= 3 MW)	Commercial	Natural Gas	PG&E	Coast	A1FTOU	Debt/Equity	None	NA	Cap/Fac	0.0	
2	No	Gas Turbine (<= 3 MW)	Commercial	OnSite Bio-Gas	PG&E	Coast	A1FTOU	Debt/Equity	None	NA	Cap/Fac	0.0	
3	No	Gas Turbine (<= 3 MW)	Commercial	Direct Bio-Gas	PG&E	Coast	A1FTOU	Debt/Equity	None	NA	Cap/Fac	0.0	
4	No	Gas Turbine (<= 3 MW)	Commercial	Natural Gas	PG&E	Inland	A1FTOU	Debt/Equity	None	NA	Cap/Fac	0.0	
5	No	Gas Turbine (<= 3 MW)	Commercial	OnSite Bio-Gas	PG&E	Inland	A1FTOU	Debt/Equity	None	NA	Cap/Fac	0.0	
6	No	Gas Turbine (<= 3 MW)	Commercial	Direct Bio-Gas	PG&E	Inland	A1FTOU	Debt/Equity	None	NA	Cap/Fac	0.0	
7	No	Gas Turbine (<= 3 MW)	Commercial	Natural Gas	SCE	Coast	G52TOU	Debt/Equity	None	NA	Cap/Fac	0.0	
8	No	Gas Turbine (<= 3 MW)	Commercial	OnSite Bio-Gas	SCE	Coast	G52TOU	Debt/Equity	None	NA	Cap/Fac	0.0	
9	No	Gas Turbine (<= 3 MW)	Commercial	Direct Bio-Gas	SCE	Coast	G52TOU	Debt/Equity	None	NA	Cap/Fac	0.0	
10	No	Gas Turbine (<= 3 MW)	Commercial	Natural Gas	SCE	Inland	G52TOU	Debt/Equity	None	NA	Cap/Fac	0.0	
11	No	Gas Turbine (<= 3 MW)	Commercial	OnSite Bio-Gas	SCE	Inland	G52TOU	Debt/Equity	None	NA	Cap/Fac	0.0	
12	No	Gas Turbine (<= 3 MW)	Commercial	Direct Bio-Gas	SCE	Inland	G52TOU	Debt/Equity	None	NA	Cap/Fac	0.0	
13	No	Gas Turbine (<= 3 MW)	Commercial	Natural Gas	SDG&E	Coast	A6TOU	Debt/Equity	None	NA	Cap/Fac	0.0	
14	No	Gas Turbine (<= 3 MW)	Commercial	OnSite Bio-Gas	SDG&E	Coast	A6TOU	Debt/Equity	None	NA	Cap/Fac	0.0	
15	No	Gas Turbine (<= 3 MW)	Commercial	Direct Bio-Gas	SDG&E	Coast	A6TOU	Debt/Equity	None	NA	Cap/Fac	0.0	
16	No	Gas Turbine (<= 3 MW)	Commercial	Natural Gas	SDG&E	Inland	A6TOU	Debt/Equity	None	NA	Cap/Fac	0.0	
17	No	Gas Turbine (<= 3 MW)	Commercial	OnSite Bio-Gas	SDG&E	Inland	A6TOU	Debt/Equity	None	NA	Cap/Fac	0.0	
18	No	Gas Turbine (<= 3 MW)	Commercial	Direct Bio-Gas	SDG&E	Inland	A6TOU	Debt/Equity	None	NA	Cap/Fac	0.0	

Setting up a Run

Setting up a batch run is done in the SGIPce workbook. There are three areas on the control worksheet.

- » Global Assumptions: Input text boxes used to describe the run
- » Technology Definitions: Technology list
- » Buttons: used to start the run and to clear or set the run flag

GLOBAL ASSUMPTIONS

The global assumptions are used to define the batch run. When a batch run is executed, the program will create aggregated results for the entire list of selected technologies and individual technology calculation workbooks for each selected technology. The aggregated results are stored in the Results directory while the individual technology workbooks are stored in the CalcEngines directory in their own subdirectory. The global assumptions and their uses are described below.

FIGURE D-4: GLOBAL ASSUMPTIONS

Global Assumptions	
Program Scenario Name	Base Case
Version Description	GTle3MW_NG_Comm_PGE
Default Year	2014
Save Calc for each line?	Yes
Store Results by Utility?	No
Update/Replace Results?	No
Save MIRR	No

- » **Program Scenario Name:** A drop-down that is used to identify the run. The Program Scenario Name is used when saving the Calculation Engine and the Results workbook.
- » **Base Case:** The default program scenario name with input values at their base level.
- » **Greenhouse Gas:** The GHG scenario with predefined changes applied to the inputs representing price changes due to more stringent regulation of GHG.
- » **Version Description:** A user-defined name used to identify the run when saving the Calculation Engine and the Results workbook.
 - > To preserve results from previous runs the user should change the value of this field. A new folder for the calculation engines will be created using the new name and a new Results workbook will also be created.
 - > If you choose to add or correct technology results in a previously defined version then use the same name as before and set Update/Replace Results? to Yes. See below for more information on this.
- » **Default Year:** The default year for the technology calculation engines. The year for which results will be presented in the LCOE tab of the technology calculation engines and in the Current Year column in the Results tab.
 - > The default year can also be changed in the Calculation Engine following the batch run to view results for each period when a Debt/Equity run has been performed.



- » **If Save MIRR...** is set to Yes, then the LCOE worksheet is set to the default year before it calculates the values of the rebates that result in the Modified Internal Rates of Return (MIRR) of 5 through 15. Using a different default year will calculate different values for these six rates.
- » **Save Calc for each line?:** If the user chooses Yes a copy of the calculation workbook for each technology in the run will be placed in a subdirectory within the CalcEngines directory.
 - > If the user chooses Yes, all inputs used to calculate the results for each technology are stored as part of the Calculation Engine workbook. The name of the individual Calculation Engine workbooks includes identifiers indicating the technology and other characteristics used for that run.
 - > If the user chooses No, a calculation workbook for the technologies in the run will not be created. A Results workbook for aggregated run will only be created.
- » **Store Results by Utility?:** If the user chooses Yes, a separate Results workbook will be created for each utility. If this flag is set to No, only one Results workbook will be created and the results for all utilities will be placed in one workbook with the suffix All.
- » **Update/Replace Results:** If the user chooses Yes, the system looks for a Results workbook with the current user defined run name to update the data that the user chose to update and to add data to a portfolio that was previously omitted.
 - > If Yes and the system finds an existing workbook with the current name it will update the results for any technology combination found in the workbook and add any new technology combinations that have been defined. Also under this option, if the technology combination exists in the workbook but not in the current run, it will not delete the pre-existing technology combinations.
- » If No the system will write a completely new Results workbook, overwriting the pre-existing workbook.
- » **Save MIRR:** Tells the system whether or not the user wants to run the code that finds the rebate in the Default Year that generates an MIRR at 1% increments from 5% up through 15%.
 - > A new version of the Calculation Engine is saved to the drive for each of the six values.
 - > Note: This can take some time so it is suggested that this be done for a small set of technologies first to understand the workbooks that are saved and how they might be used.

TECHNOLOGY DEFINITIONS

Technology Definitions, seen in Figure D-5, are used to define the technologies to be included in the batch run. There are 342 technology definition combinations from which to choose. The following are descriptions of the drop downs available within Technology Definitions. Also for ease of use, the filtering option is available for most of the technologies and the parameters, making it easier to select what the user wishes to run.



FIGURE D-5: TECHNOLOGY DEFINITIONS

Run Number	Run Technology Flag	Technology Name	Sector	Fuel Type	Utility	Climate Region	Utility Ra	Financing Opti	Rebate Ty	Progress Ratio	Technology Scenario Descripto	Expected Capacity Factor
1	No	Gas Turbine (<= 3 MW)	Commercial	Natural Gas	PG&E	Coast	A10TOU	Debt/Equity	None	NA	CapFac	0.8
2	No	Gas Turbine (<= 3 MW)	Commercial	OnSite Bio-Gas	PG&E	Coast	A10TOU	Debt/Equity	None	NA	CapFac	0.8
3	No	Gas Turbine (<= 3 MW)	Commercial	Direct Bio-Gas	PG&E	Coast	A10TOU	Debt/Equity	None	NA	CapFac	0.8
4	No	Gas Turbine (<= 3 MW)	Commercial	Natural Gas	PG&E	Inland	A10TOU	Debt/Equity	None	NA	CapFac	0.8

- » **Run Technology Flag:** Yes/No flag to include or not include a technology in the analysis.
 - > To see all technologies, click on the Run Technology Flag drop-down button and choose Select All.
 - > The user can choose to set all flags to No or Yes using the buttons on the upper right-hand side of the SGIPce.
 - > If the flags are in the Yes position, the user could turn some technology flags to No. Setting the flags to No in the Run Technology Flag column removes the technology from the batch run.
 - > If the user has a limited number of technologies, they may want to set all technologies to No with the Set Run Tech Flag Off button from the menu at the top right of the worksheet. Then the user could select the technologies they wish to include in the analysis by setting those technologies to Yes in the Run Technology Flag column.
- » **Technology Name:** A short description of the technology represented by the line.
- » **Sector:** An identifier indicating if the line is for the commercial, government/nonprofit, or residential sector.
- » **Fuel Type:** Identifies the type of fuel to be used to run the technology for the current line. The field may take the following values: *natural gas, directed bio-gas, onsite bio-gas, or none.*
- » **Utility:** An identifier indicating the utility for the current line. This field may have the following values: *PG&E, SCE, SDG&E.*
- » **Climate Region:** An identifier indicating the Climate Region being used by the line. The field may have the following values: *Coast, Inland.*
- » **Utility Rate:** The user must choose a utility rate from the drop-down menu.
 - > The user is only provided with rates defined in the system that are appropriate for the chosen utility and sector.
- » **Financing Option:** The user can choose from the two financing options in the drop-down menu: *Debt/Equity* and *power purchase agreement (PPA).*
- » **Rebate Type:** The user has five rebate options to choose from:
 - > If the user chooses None, no rebate is provided during the forecasting period.
 - > EPBB is an expected performance based buy down or a first-year rebate. The rebate values are based upon current rebates or plans for future rebates.
 - > PBI is a performance based incentive or a five-year rebate. The rebate is based upon current rebates or plans for future rebates.
 - > EPBB-CA represents the upfront rebate where the equipment supplier is located in California.

- > PBI-CA represents the performance based incentive provided when the equipment supplier is located in California.
- » **Progress Ratio:** The user has the ability to modify the progress ratio currently stored in the technology workbooks. The base value of the progress ratio listed in the technology definitions is NA.
 - > Leaving the progress ratio at NA causes the system to use the current observed progress ratio to determine the future path of technology costs.
 - > Changing the progress ratio from NA will lead the path of technology costs to differ from those observed in currently learning curve research. The Progress Ratio must be between zero and one. An example of the List of Technologies being used to set the Progress Ratio can be seen in Figure D-5.
- » **Technology Scenario Description:** May be used to differentiate each technology in a run.
 - > This field is currently used on the cover page of the Calculation Engine to help differentiate the various runs. The user can select one of three values in the field. They are NA, CapFac for a change in the Expected Capacity Factor, and ProgRatio for a change in the Progress Ratio.
 - > Again, this field is informational only and is not used to identify the runs in any way.
- » **Expected Capacity Factor:** May be used to adjust the production curves to represent a user-specified value for the capacity factor. The production curve is adjusted mathematically so that the average calculates to the specified value if possible.
 - > The default “expected” annual average capacity factor is 0.8.
 - > The maximum allowable value for any given hour in the production function is 1.05.
 - > The word “Actual” tells the program to use the assigned production function without adjustment.

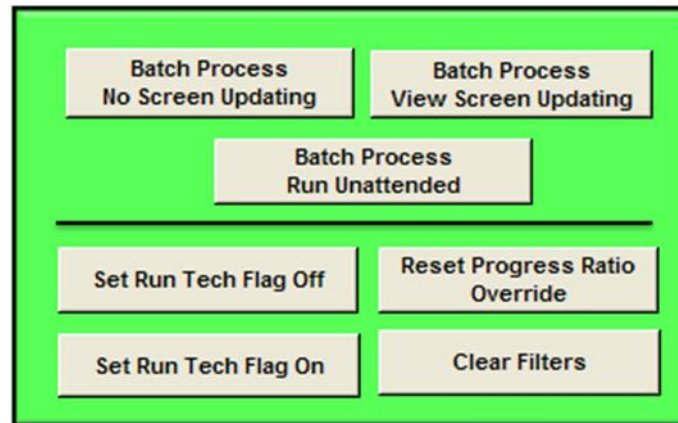
FIGURE D-6: TECHNOLOGY DEFINITIONS (CONTINUED)

The screenshot displays the SGIPce Program Scenario Simulator interface. It includes a 'Global Assumptions' panel with fields for Program Scenario Name (Base Case), Version Description (GT3MW_NC_Comm_PGE), Default Year (2014), and other settings. A 'Batch Processing' panel contains buttons for 'Batch Process: No Screen Updating', 'Batch Process: View Screen Updating', 'Batch Process: Run Unattended', 'Set Run Tech Flag Off', 'Reset Progress Ratio Override', 'Set Run Tech Flag On', and 'Clear Filters'. Below these is a 'Technology Definitions' table with columns for Run Number, Run Technology Flag, Technology Name, Sector, Fuel Type, Utility, Climate Region, Utility Rate, Financing Option, Rebate Type, Progress Ratio, Technology Scenario Description, Expected Capacity Factor, and Error Condition.

Run Number	Run Technology Flag	Technology Name	Sector	Fuel Type	Utility	Climate Region	Utility Rate	Financing Option	Rebate Type	Progress Ratio	Technology Scenario Description	Expected Capacity Factor	Error Condition
1	No	Gas Turbine (<= 3 MW)	Commercial	Natural Gas	PG&E	Coast	AHTOU	Debt/Equity	None	NA	CapFac	0.8	
2	No	Gas Turbine (<= 3 MW)	Commercial	OnSite Bio-Gas	PG&E	Coast	AHTOU	Debt/Equity	None	NA	CapFac	0.8	
3	No	Gas Turbine (<= 3 MW)	Commercial	Direct Bio-Gas	PG&E	Coast	AHTOU	Debt/Equity	None	NA	CapFac	0.8	
4	No	Gas Turbine (<= 3 MW)	Commercial	Natural Gas	PG&E	Island	AHTOU	Debt/Equity	None	NA	CapFac	0.8	
5	No	Gas Turbine (<= 3 MW)	Commercial	OnSite Bio-Gas	PG&E	Island	AHTOU	Debt/Equity	None	NA	CapFac	0.8	

SGIPCE Batch Processing Buttons

The SGIPce interface includes seven buttons (see Figure D-6). Three of the seven buttons start the batch processor while four of the buttons are used to set up the Technology definitions. Following are descriptions for the buttons shown in more detail in Figure D-7.

FIGURE D-7: SGIPce BUTTONS

- » Batch Process – No Screen Updating
 - > This button runs the system with minimal screen updating during the run.
 - > Some updating is performed after each run to help inform the user as to how far the batch run has progressed.
 - > This type of run is faster because the screen is not continuously updated.
 - > At the end of this run, any open Results workbooks will be saved automatically with their default names.
- » Batch Process – View Screen Updating
 - > This button runs the system with complete screen updating during the run.
 - > Allows the user to view what is happening at all times.
 - > Provides a progress bar on the status of the run.
 - > May impact performance, but the user is never guessing about the progress of the batch run.
 - > At the end of this run, the user will be asked to save any open Results workbooks before the VBA code finishes. This allows the user to rename the workbook if desired.
- » Batch Process – Run Unattended
 - > This button is designed for a longer run with many technologies defined.
 - > At this time, screen updating is turned on with this run.
 - > The difference with this run type is that all workbooks are closed down when the run completes and the SGIPce workbook is save and closed as well. This assures that no information about the run is lost.
 - > At the end of this run, any open Results workbooks will be saved automatically with their default names.
- » Clear Filters
 - > This button clears all filters, manually set by the user, limiting the visible rows in the Technology Definitions table.
 - > This button should be pressed before using the following three buttons.
- » Set Run Tech Flag Off

- > This button sets to No the list of Run Tech Flag values.
- > Allows for a reset of the flags before defining a new run.
- > The user may select specific technologies after pressing this button to turn them on.
- > For reliable results the user should always press the Clear Filter button, described above, before pressing this button. This will ensure that all Run flags are turned off.
- » Set Run Tech Flag On
 - > This button sets to Yes the list of Run Tech Flag values.
 - > Allows for all technologies to be run at the same time.
 - > The user may unselect specific technologies after pressing this button to turn them off.
 - > For reliable results the user should always press the Clear Filter button, described above, before pressing this button. This will ensure that all Run flags are turned on.
- » Reset Progress Ratio Override
 - > This button sets to NA the entire list of Progress Ratio values.
 - > Assures that the run being defined does not have any errant values in this column.
 - > Values in this column may be set manually to values within the following range: $(0 < \text{ratio} \leq 1)$.
 - > For reliable results the user should always press the Clear Filter button, described above, before pressing this button. This will ensure that all Progress Ratio flags are set to NA.

What Happens When You Press a Batch Processing Button?

Pressing a batch processing button begins the VBA code that runs through the technologies and produces results for the selected technologies. Before anything further happens, the user has the opportunity to cancel the process before it continues.

Depending on which button is pressed, the user may be able to watch the progress of the runs as the workbooks are opened and closed and data are being moved from the Input workbooks to the Calculation Engine and then to the Results workbook. The operation of each button should be reviewed to determine the best operation for the situation.

At the end of the run, the disposition of the open Results workbooks and the SGIPce workbook is determined based on the button pressed. Be sure to review above how each button treats these workbooks at the end of a run.

Where are the Results?

If the user chooses to save the calculations for each line item (technology), the technology-level results are saved in the CalcEngines folder and the aggregated results with some technology-level information are saved in the Results folder. The *Program Scenario Name* and the *Version Description* are used to help define the name of the CalcEngines folder and the Results workbook. An example of the naming convention follows:

- » Combined Results Workbook Naming Convention:



- » Store Results by Utility equals No.
- » Only one Results workbook is created.
- » The name is made up of four components.
 1. *SGIPce_Results_* – prefix for all Results workbooks.
 2. *Program Scenario Name* – selected by the user in SGIPce.
 3. *Version Description* – defined by the user in the SGIPce.
 4. *All* – indicating that all utilities are included in the Results workbook.
- » Results Workbook by Utility Naming Convention:
- » Store Results by Utility equals Yes.
- » One Results workbook is created for each utility selected in the List of Technologies in SGIPce.
- » The naming convention is the same as for the combined results with one exception:
- » Item number 4 above changes from All to the utility’s initials (e.g. PGE,SCE, SDGE)

Error Log

Another tab of interest in the SGIPce workbook is the Error Log. After each attended batch run, the SGIPce workbook will open with the Error Log displayed. It is important to review this worksheet to determine if there were any errors during the run that might have stopped the system prematurely or may have caused erroneous values to be stored in the results.

FIGURE D-8: ERROR LOG

Type of Message	Error Number	Source	Programer Description	Error Description	Time/Date Stamp	Time Difference
Information	NA	SGIPceBatchProcessor	Init Error Handler	None	3/18/2015 16:32	
Information	NA	SGIPce_CalcEngine	Starting Run Number: 112; Tech Suffix:ICE1500kW_NR_NG	None	3/18/2015 16:32	00:00:10
Information	NA	SGIPce_CalcEngine	Before PopulateInputs for Run Number: 112; Tech Suffix:ICE1500kW	None	3/18/2015 16:33	00:00:41
Information	NA	SGIPce_CalcEngine	Start PopInputs for Run Number: 112	None	3/18/2015 16:33	00:00:00
Information	NA	SGIPce_CalcEngine	Before Tech Activate for Run Number: 112	None	3/18/2015 16:33	00:00:00
Information	NA	SGIPce_CalcEngine	Before AnnInputs Activate for Run Number: 112	None	3/18/2015 16:33	00:00:01
Information	NA	SGIPce_CalcEngine	Before Finance Activate for Run Number: 112	None	3/18/2015 16:33	00:00:00
Information	NA	SGIPce_CalcEngine	Before Results Activate for Run Number: 112	None	3/18/2015 16:33	00:00:00
Information	NA	SGIPce_CalcEngine	End PopInputs for Run Number: 112	None	3/18/2015 16:33	00:00:00
Information	NA	SGIPce_CalcEngine	Before CalcLCOE for Run Number: 112; Tech Suffix:ICE1500kW_NI	None	3/18/2015 16:33	00:00:01
Information	NA	SGIPce_CalcEngine	Before StoreResults for Run Number: 112; Tech Suffix:ICE1500kW	None	3/18/2015 16:33	00:00:12
Information	NA	SGIPce ResultsTemplate	Added Data Tab for: ICE1500kW_NR_NG_PGE_I	None	3/18/2015 16:33	00:00:08
Information	NA	SGIPce ResultsTemplate	Start writing	None	3/18/2015 16:33	00:00:00
Information	NA	SGIPce ResultsTemplate	End writing	None	3/18/2015 16:33	00:00:00
Information	NA	SGIPce_CalcEngine	Before Save CalcEngine for Run Number: 112; Tech Suffix:ICE1500	None	3/18/2015 16:33	00:00:01
Information	NA	SGIPce_CalcEngine	Ending Run Indx: 0; Run Number: 112	None	3/18/2015 16:33	00:00:15
Information	NA	SGIPce_CalcEngine	Starting Run Number: 118; Tech Suffix:ICE1500kW_NR_NG	None	3/18/2015 16:33	00:00:00
Information	NA	SGIPce_CalcEngine	Before PopulateInputs for Run Number: 118; Tech Suffix:ICE1500kW	None	3/18/2015 16:34	00:00:50
Information	NA	SGIPce_CalcEngine	Start PopInputs for Run Number: 118	None	3/18/2015 16:34	00:00:00
Information	NA	SGIPce_CalcEngine	Before Tech Activate for Run Number: 118	None	3/18/2015 16:34	00:00:00
Information	NA	SGIPce_CalcEngine	Before AnnInputs Activate for Run Number: 118	None	3/18/2015 16:34	00:00:00
Information	NA	SGIPce_CalcEngine	Before Finance Activate for Run Number: 118	None	3/18/2015 16:34	00:00:01
Information	NA	SGIPce_CalcEngine	Before Results Activate for Run Number: 118	None	3/18/2015 16:34	00:00:00
Information	NA	SGIPce_CalcEngine	End PopInputs for Run Number: 118	None	3/18/2015 16:34	00:00:00
Information	NA	SGIPce_CalcFnine	Before CalcI COE for Run Number: 118; Tech Suffix:ICF1500kW_NI	None	3/18/2015 16:34	00:00:01

The following is a description of each of the fields in the Error Log and how they may be interpreted.

- » Type of Message
 - > Information. This indicates that the data on this line are for the user’s information only. No error is indicated here.



- > Error. This indicates that an error has occurred that needs to be addressed for the specified technology.
- » Error Number
 - > NA. This indicates that there is not error number. This value should only be seen on information lines.
 - > <numeric value>. This number can be searched for in the VBA code to determine where the error occurred. With this information, the developer can find the problem and make any necessary corrections to the code or inputs.
 - > It is not advised that the user make changes to the code to solve a problem. If code is changed then the users system is no longer compatible with the other versions and cannot be maintained by the developer.
- » Source
 - > This is additional information to help determine the origin of the problem causing the error. While the error might need to be worked on by the developer, the user can review the information in this and other fields to determine if an input error has occurred that they can fix.
- » Programmer Description
 - > This describes the area where the problem occurred in the code.
- » Error Description
 - > This is a more specific comment about the actual area of the code where the problem occurred.
- » Time/Date Stamp
 - > This is the value of the system clock at the time the error was reported.
- » Time Difference
 - > This is the difference in time between the current and previous entries. This is a good indicator of how long each run takes to complete.

Analyzing these codes can be very helpful in determining if an error has occurred to a programming problem or to a problem with the data inputs. When reviewing the error log, the user should always ask, “What has changed since the last run?” This helps identify the problem so that corrections can be made in a timely manner, thereby enabling a successful run.

Calculation Engine

In the system’s root directory is a workbook named *SGIPce_CalcEngine.xlsm*. This is a template that represents the format of the CalcEngine that will be populated with the inputs specified by the current technology line being executed in the batch run. Actual technology-level results are found in the CalcEngines directories. The individual technology CalcEngine workbooks are named for the *Program Scenario Name* and *Version Description* specified in the Technology Description and are further identified using the technology name, sector (commercial = NR, residential = Res, government/non-profit (GNP), fuel, and California utility). The Calculation Engines contain all the information used to generate the results found in the Results workbook for the individual technologies.



The technology-level Calculation Engine includes several tabs of interest, such as Cover Sheet, Results, LCOE, as well as multiple input tabs. Each tab is described briefly below.

Information Tabs

Cover Sheet

The Cover Sheet of the technology-specific Calculation Engine lists the Global Assumptions the user specified in the SGIPce and the Technology Definitions for the individual technology. This shows the basic information used to determine what input data were used to define the technology.

FIGURE D-9: CALCULATION ENGINE COVER SHEET

SGIPce Program Calculation Engine	
Global Assumptions	
Program Scenario Name	BaseCase
Version Description	Comm_Storage_30kW_I
Default Year	2014
Save Calc for each line?	Yes
Store Results by Utility?	No
Update/Replace Results?	No
Technology Definitions	
Run Number	152
Technology Name	Storage (30 kW)
Sector	Commercial
Fuel Type	None
Utility	PG&E
Utility Rate	A10TOU
Climate Region	Inland
Financing Option	Debt/Equity
Rebate Type	None
Progress Ratio Override	No Change
Technology Scenario Descriptor	NA
Technology Suffix	Storage30kW_NR_NA
Expected Capacity Factor	0.06



CALCULATION TABS

Results Tab

The Total Resource Cost (TRC) test, the Societal Total Resource Cost (STRC) test, the Participant Cost (PCT) test, and the Program Administrator Cost (PAC) test are presented for the technology on the Results tab. Figure D-10 is an example of information presented in the Results tab.

FIGURE D-10: RESULTS PAGE EXAMPLE

SGIPce Results											
Item Number	156	Fuel Type	None	CZ Region	Inland	Prgrs Ratio	NA	Expected Cap. Fac.	0.06		
Tech Name	Storage (30 kW)	Utility	SDG&E	Finance Optn	Debt/Equity	Tech Seen Desc	NA				
Sector	Commercial	Utility Rate	A6TOU	Rebate Type	None	Tech Suffix	Storage30kW_NR_NA_SDGE_J				
Benefit/Cost Test Calculations		Discount Rate	2011	2012	2013	2014	2015	2016	2017	2018	2019
TRC											
TRC Benefits			\$8,995	\$9,111	\$9,222	\$8,923	\$8,654	\$8,440	\$8,245	\$8,076	\$8,011
TRC Costs			\$14,166	\$14,300	\$14,447	\$14,436	\$12,559	\$11,902	\$11,161	\$10,620	\$10,053
TRC Net Benefits			(\$5,171)	(\$5,190)	(\$5,225)	(\$4,513)	(\$3,905)	(\$3,363)	(\$2,916)	(\$2,544)	(\$2,042)
TRC Benefits Ratio			63.5%	63.7%	63.8%	66.4%	69.0%	71.5%	73.9%	76.0%	79.7%
TRC - Societal											
TRC - Societal Benefits			\$9,661	\$9,775	\$9,886	\$9,628	\$9,409	\$9,224	\$9,068	\$7,938	\$7,897
TRC - Societal Costs			\$13,345	\$13,484	\$13,633	\$12,718	\$11,923	\$11,237	\$10,653	\$10,157	\$9,649
TRC - Societal Net Benefits			(\$4,684)	(\$4,707)	(\$4,747)	(\$4,089)	(\$3,514)	(\$3,013)	(\$2,585)	(\$2,219)	(\$1,752)
TRC - Societal Benefits Ratio			64.9%	65.1%	65.2%	67.8%	70.5%	73.2%	75.7%	78.1%	81.8%
PCT											
PCT Benefits			\$15,003	\$15,345	\$15,678	\$15,502	\$15,389	\$15,325	\$15,320	\$15,362	\$15,449
PCT Costs			\$13,667	\$13,723	\$13,781	\$12,678	\$11,700	\$10,831	\$10,063	\$9,365	\$8,798
PCT Net Benefits			\$1,336	\$1,623	\$1,897	\$2,823	\$3,689	\$4,494	\$5,257	\$5,977	\$6,662
PCT Benefits Ratio			109.8%	111.8%	113.8%	122.3%	131.5%	141.5%	152.2%	163.7%	175.8%
PA											
PA Benefits			\$0	\$0	\$0	\$0	\$0	\$0	\$0	\$0	\$0
PA Costs			\$0	\$0	\$0	\$0	\$0	\$0	\$0	\$0	\$0
PA Net Benefits			\$0	\$0	\$0	\$0	\$0	\$0	\$0	\$0	\$0
PA Benefits Ratio			0.0%	0.0%	0.0%	0.0%	0.0%	0.0%	0.0%	0.0%	0.0%
Levelized Lifetime Values		Discount Rate	2011	2012	2013	2014	2015	2016	2017	2018	2019
Levelized Cost of Generation (\$/kWh)			\$0.54	\$0.55	\$0.55	\$0.50	\$0.46	\$0.43	\$0.39	\$0.36	\$0.34
% Financed w/ equity			30.0%	30.0%	30.0%	30.0%	30.0%	30.0%	30.0%	30.0%	30.0%

LCOE Tab

The LCOE tab contains results of the financial calculations needed to determine the levelized cost of energy. Many of the calculations on this page are also used to help determine the costs and benefits for the cost-benefit tests listed on the Results tab. An example of the LCOE results is shown in Figure D-11.

FIGURE D-11: LCOE PROFORMA SHEET EXAMPLE

LCOE ProForma											
<i>(in actual dollars)</i>											
Change Default Year											
Change Default Year 2014											
System Design			Tax Assumptions				Financing				
System Cost per Watt (\$/Watt ACIDC) (ALL IN)	2.72498892	Tech	Federal Tax Rate	35.00%	Global-Sector	% Financed w/ equity	30%				
System Size (Design) (kW ACIDC)	30	Tech	State Tax Rate	8.84%	Global-Sector	% Financed w/ debt	70%				
Initial debt service reserve funding	\$0.0000	Calc	Effective Tax Rate	40.75%	Global-Sector	Debt Interest rate	7.67%	Global-Sector			
Upfront rebate reduction	\$0	Calc	Taxable electricity	0	Calc	Debt period in years	10	Calc			
Total System Cost	\$81,745	Calc	Taxable PBI Incentive (Federally) (1=yes,0=no)	1	Calc	Year Debt Placed	1	Const			
Performance Inputs			Federal Tax Credit				Equity				
System Size Derate Factor	1.00	Tech	Total System Cost	\$81,746	Calc	WACC	8.25%	Global-Sector			
System Size (Performance) (kW AC)	30	Calc	Tax Credit Rate	0%	Tech	Interest Rate on DSPF	3.8%	Global-Sector			
Annual Net AC Capacity Factor	8.7%	Tech	Tax Credit Amount	\$0	Calc	PPA Escalator	0.00%	Global-Sector			
Annual Output for Year 1 (kWh)	17,520	Calc	Tax Savings through Depreciation			Debt					
Degradation Factor	1.00%	Tech	Full Basis Amount	\$81,746	Calc	Equity Amount	\$24,524	Calc			
System lifetime (in Years)	15.00	Tech	Basis Reduction (50% of ITC)	0%	Calc	Debt Amount	\$57,222	Calc			
Other			MACRS Term				Program Admin Cost (\$/kWh)				
OBM Costs (\$/kWh)	\$0.0283	Tech	Depreciation Basis	\$81,746	Calc	Program Admin Cost (\$/kWh)	\$40.04	Tech			
OBM Costs Escalator (%/yr)	2.00%	Global	MACRS Term	7	Tech	Program Admin Cost (\$/unit)	\$0.00	Tech PV only			
Partial Equip Replacement Cost (\$/W)	\$0.00	Tech	Slate Rebate			Output					
Partial Equip replacement time (in Years)	1	Tech	Rebate Amount (\$/kWh)	None	None	Levelized Cost of Generation (\$/kWh)	\$0.5421	Calc			
Partial Equip replacement cost	\$0.00	Calc?	PBI	No	Calc	NPV	\$0.00	Calc			
Levelized (1/yr) Partial Equip replacement cost	-	Calc?	Rebate Amount Per Watt AC	\$0.62	Calc	REC Start Year	2013	Constant			
Insurance Expense Multiplier (%)	0.5%	Tech	EPBB - Upfront	\$162	Calc	Number of years rebated	5	Tech			
Insurance Escalator (%/yr)	2.00%	Tech	CEC-AC Rating	3.0	Calc	Inflation Rate	2%	Global			
REC price (\$/kWh)	\$0.00	Tech	CEC-AC Rating (+CEC-AC * Design Factor)	3.0	Calc	Years of Debt Service in DSPF	1	Global-Sector/Finance			
REC price escalator (%/yr)	0.00%	Tech	Total Upfront Rebate Amount	\$48,600	Calc	Target DSCR	1.40	Global-Sector			
REC price multiplier (1.0)	1	Tech	Design Derate Factor			Technology					
What year does replacement of other equip occur?	1	Tech				100.00%					



DATA TABS

Inputs Tabs

The Inputs tab holds the Annual Inputs table seen in Figure D-12 and lists many of the SGIP measure inputs and financial assumptions used to calculate the LCOE and the cost-benefit test values. This tab aggregates the inputs for use in the LCOE worksheet. This tab references the subsequent input tabs so that the iterative process of calculating the levelized cost of energy by period can be performed.

FIGURE D-12: ANNUAL INPUTS TABLE EXAMPLE

Inputs (itron_wInputTable)		this workbook.								
System Price		2016	2017	2018	2019	2020	2021	2022	2023	2024
Measure Price (\$/W)	Tech/Annual	\$2.18	\$1.95	\$1.75	\$1.57	\$1.40	\$1.26	\$1.12	\$1.01	\$0.90
Inverter Price (\$/W)	Tech/Annual	\$0.00	\$0.00	\$0.00	\$0.00	\$0.00	\$0.00	\$0.00	\$0.00	\$0.00
Other Costs (\$/W)	Tech/Annual	\$0.00	\$0.00	\$0.00	\$0.00	\$0.00	\$0.00	\$0.00	\$0.00	\$0.00
System Cost per Watt	Calc	\$2.18	\$1.95	\$1.75	\$1.57	\$1.40	\$1.26	\$1.12	\$1.01	\$0.90
Performance Inputs										
Annual Net Capacity Factor	Tech/Const	7%	7%	7%	7%	7%	7%	7%	7%	7%
System lifetime (Years)	Tech/Const	15	15	15	15	15	15	15	15	15
Degradation Factor (%/yr)	Tech/Const	1%	1%	1%	1%	1%	1%	1%	1%	1%
DC to AC derate factor	Tech/Const	100%	100%	100%	100%	100%	100%	100%	100%	100%
Cost Inputs										
O&M Costs (\$/kW)	Tech/Annual	\$0.03	\$0.03	\$0.03	\$0.03	\$0.03	\$0.03	\$0.03	\$0.03	\$0.03
O&M Cost Escalator (%/yr)	Global	2.00%	2.00%	2.00%	2.00%	2.00%	2.00%	2.00%	2.00%	2.00%
Partial Equip replacement costs (\$/W)	Tech/Annual	\$0.00	\$0.00	\$0.00	\$0.00	\$0.00	\$0.00	\$0.00	\$0.00	\$0.00
Partial Equip replacement time (Years)	Tech/Const	1	1	1	1	1	1	1	1	1
Insurance Expense Multiplier (%)	Global	0.5%	0.5%	0.5%	0.5%	0.5%	0.5%	0.5%	0.5%	0.5%
Insurance Escalator (%/yr)	Global	2.00%	2.00%	2.00%	2.00%	2.00%	2.00%	2.00%	2.00%	2.00%
REC price (\$/W)	Tech	\$ -	\$ -	\$ -	\$ -	\$ -	\$ -	\$ -	\$ -	\$ -
REC price escalator (%/yr)	Tech	0%	0%	0%	0%	0%	0%	0%	0%	0%
REC price multiplier	Tech/Global?	1	1	1	1	1	1	1	1	1
Finance Inputs										

Technology Tab

The Technology tab holds the Technology Level Constants Table as see in Figure D-13 , which lists the technology constants used to calculate the LCOE and the cost-benefit tests. These data are retrieved from the appropriate technology input workbook.



FIGURE D-13: TECHNOLOGY-LEVEL CONSTANTS EXAMPLE

Technology Level Constants		
Inputs by Tech	Value	Comments
System Size (kW)	30	Mapped to LCOE tab C11
System Size Derate Factor	1	Mapped to Input Tab
Annual Net AC Capacity Factor	0.066666667	Mapped to Input Tab
Degradation Factor	0.01	Mapped to Input Tab
System lifetime (in Years)	15	Mapped to Input Tab
Emissions Factors - CO2 (lbs/MWh)	0	Used in LCOE worksheet
Emissions Factors - NOx (lbs/MWh)	0	Used in LCOE worksheet
Emissions Factors - PM10 (lbs/MWh)	0	Used in LCOE worksheet
Depreciation Term	7	Mapped to LCOE tab H25
Partial Equip replacement cost (\$/W)	0	
Partial Equip Replacement Time (years)	0	Mapped to Input Tab. Needs clarification
Program Admin Cost (nonrebate, \$/unit)	\$0.00	Used for PV
Program Admin Cost (nonrebate, \$/kW)	\$40.04	Used for non-PV technologies
PAC price escalator (%/yr)	0.0%	Program Admin Cost Price Escalator
Annual Electric Production	17,520	From Technology Production Curves
Annual Electric Charging	20940.23904	From Technology Charging Curves for Storage
Annual Gas Production Therms Req'd	0	From Technology Production Curves
Annual Gas Production Therms Out	0	From Technology Production Curves
On-site Biogas Technology?	FALSE	Controls inputs during calculation
Design Derate Factor	100.00%	Should be 100% for all techs except PV when it is initialized
Installed at a Dairy?	No	Was Technology installed at a Dairy?
Pay Departing Charge?	0.00%	Should Departing Charges be Applied?
California Purchasing Discount	20.00%	Purchasing discount for buying equipment made in California

Note: all values on this worksheet are obtained from the technology workbook selected for the run.
 Annual Production values are retrieved from the TechnologyProduction worksheet.
 All other values come from the Constants worksheet.
 The workbook names are found in the Inputs sub-directory and have the prefix SGIPce_Inputs_Tech_xx.xlsx

Annual Inputs Tab

This tab lists many of the technology annual inputs used to calculate the LCOE and the cost-benefit tests. Items included on the Annual Inputs tab include the price of the SGIP technology and how market transformation impacts the price of the technology.



FIGURE D-14: TECHNOLOGY-LEVEL ANNUAL INPUTS EXAMPLE

Short-term Inputs (14 periods)												
System Prices												
		Est. Growth Rate	2011	2012	2013	2014	2015	2016	2017	2018	2019	2020
Cumulative global capacity	(MW)	50%	4	4	4	5	8	12	18	27	41	62
Price	(nominal \$/W)	80.00%	\$ 3.04	\$ 3.04	\$ 3.04	\$ 2.72	\$ 2.44	\$ 2.18	\$ 1.95	\$ 1.75	\$ 1.57	\$ 1.40
Historical Price	(nominal \$/kW)	80.00%	\$3,044	\$3,044	\$3,044							
The values in orange are obtained from the technology workbook selected for this run on the worksheet named AnnualInputs												
Other Prices												
		Escalator	2011	2012	2013	2014	2015	2016	2017	2018	2019	2020
Inverter Price	(\$/W)	0%	\$0.00	\$0.00	\$0.00	\$0.00	\$0.00	\$0.00	\$0.00	\$0.00	\$0.00	\$0.00
Historical Other Prices	(\$/W)	0%	\$0.00	\$0.00	\$0.00	\$0.00	\$0.00	\$0.00	\$0.00	\$0.00	\$0.00	\$0.00
Inverter Price	(\$/kW)		\$0.00	\$0.00	\$0.00							
Historical Other Prices	(\$/kW)		\$0.00	\$0.00	\$0.00							
The values in orange are obtained from the technology workbook selected for this run on the worksheet named AnnualInputs. Inverter Price is not currently used												
O&M												
		Escalator	2011	2012	2013	2014	2015	2016	2017	2018	2019	2020
Cost	(\$/kWh)	0%	\$0.03	\$0.03	\$0.03	\$0.03	\$0.03	\$0.03	\$0.03	\$0.03	\$0.03	\$0.03
Historical Cost	(\$/kWh)		\$0.03	\$0.03	\$0.03							
The values in orange are obtained from the technology workbook selected for this run on the worksheet named AnnualInputs												
REC Inputs												
			2011	2012	2013	2014	2015	2016	2017	2018	2019	2020
Price	(\$/W)		\$0.000	\$0.000	\$0.000	\$0.000	\$0.000	\$0.000	\$0.000	\$0.000	\$0.000	\$0.000
Escalator	(%/Yr)		0.0%	0.0%	0.0%	0.0%	0.0%	0.0%	0.0%	0.0%	0.0%	0.0%
Multiplier	(1.0)		1	1	1	1	1	1	1	1	1	1
The values in orange are obtained from the technology workbook selected for this run on the worksheet named AnnualInputs												
Rebates												
		Years	2011	2012	2013	2014	2015	2016	2017	2018	2019	2020
EPBB	(\$/W)		\$2.00	\$2.00	\$1.80	\$1.62	\$1.46	\$1.31	\$1.18	\$1.06	\$0.96	\$0.86
PBI	(\$/kWh)	5	\$0.7610	\$0.7610	\$0.6849	\$0.6164	\$0.5548	\$0.4993	\$0.4494	\$0.4044	\$0.3640	\$0.3276

Finance Tab

The Finance tab lists the financial inputs used to calculate the LCOE and the cost-benefit tests. This tab includes both the Global and Annual inputs needed for the financial calculations in the LCOE worksheet. Figure D-15 is an example of the Global Financial inputs.

FIGURE D-15: GLOBAL FINANCE INPUTS

Global Variables												
Utility Discount Rate	8.65%	This value is initialize from SGIPce_Inputs_Global.xlsm on the Global_Constants tab										
Societal Discount Rate	5.06%	This value is initialize from SGIPce_Inputs_Global.xlsm on the Global_Constants tab										
PPA Escalator	0.00%											
Rebate Type	1	None = 1, PBI = 2, EPBB = 3, PBI-CA= 4, EPBB-CA=5										
Financing Inputs												
		2011	2012	2013	2014	2015	2016	2017	2018	2019	2020	
Debt/Equity												
Federal Tax Rate		35%	35%	35%	35%	35%	35%	35%	35%	35%	35%	
State Tax Rate		8.84%	8.84%	8.84%	8.84%	8.84%	8.84%	8.84%	8.84%	8.84%	8.84%	
Apply Tax Credit		1	1	1	1	1	1	1	1	1	1	
Percent financed with Equity		30%	30%	30%	30%	30%	30%	30%	30%	30%	30%	
Debt Interest Rate		0.08	0.08	0.08	0.08	0.08	0.08	0.08	0.08	0.08	0.08	
Target DSCR		1.40	1.40	1.40	1.40	1.40	1.40	1.40	1.40	1.40	1.40	
Years of Debt Service in DSRF		1	1	1	1	1	1	1	1	1	1	
WACC		8.25%	8.25%	8.25%	8.25%	8.25%	8.25%	8.25%	8.25%	8.25%	8.25%	
Cost of Equity		16.89%	16.89%	16.89%	16.89%	16.89%	16.89%	16.89%	16.89%	16.89%	16.89%	
		-	-	-	-	-	-	-	-	-	-	

Note: all values in yellow are initialized from the SGIPce_Inputs_Global.xlsm workbook. They come from the tab named Global_Financing. Greyed values are not used

RESULTS WORKBOOK

The Results workbook lists the aggregated results for the analysis across all technologies included in the run and has individual technology results tabs for each technology included in the batch analysis. The



Results workbook includes a cover sheet, a technology-level adoption tab, a tab summarizing the technology-specific per-unit cost-benefit results, a tab summarizing the total technology cost-benefit results, and technology-specific results tabs.

Results Cover Tab

The Results Cover tab lists the *Program Scenario Name* and *Version Description*. These fields help to ensure that the user is looking at the desired set of output.

FIGURE D-16: RESULTS COVER EXAMPLE

SGIPce Program Results	
Global Assumptions	
Program Scenario Name	BaseCase
Version Description	Comm_Storage_30kW_I
Default Year	2014

Results Adoption Tab

The adoption tab includes an estimate of the technology capacity (MW) adoption for each technology and year. Note that technology adoptions can be changed to enable scenario planning. For example, the user can change the mix of renewable energy, storage or gas-fired CHP to determine the different cost impacts. The baseline technology adoptions for the years 2011 through 2014 are based on historical California data while the values for 2015 through 2024 are based on the CEC Road Map of Distributed Generation² and on the ICF Market Distributed Generation Market Potential Study.³ Note also that the importance of technology adoptions is less about absolute values and more about comparisons between different resources mixes and their rates of adoption.

² *Distributed Generation and Cogeneration Policy Roadmap for California*, CEC-500-2007-021, March 2007.

³ *Combined Heat and Power Market Assessment*, prepared for the California Energy Commission, ICF, CEC-500-2009-094-D, October 2009.



FIGURE D-17: RESULTS ADOPTION SHEET EXAMPLE

	H	I	J	K	L	M	N	O	P	Q	R	S	T	U	V	W	
	Adoptions (MW)	per Unit	2011	2012	2013	2014	2015	2016	2017	2018	2019	2020	2021	2022	2023	2024	
2	WD50kW_Res_NA_PGE_C	0.050	-	-	-	0.1	0.1	0.1	0.1	0.1	0.1	0.1	0.1	0.2	0.2	0.2	
3	WD50kW_Res_NA_PGE_I	0.050	-	-	-	0.1	0.1	0.1	0.1	0.1	0.1	0.1	0.1	0.2	0.2	0.2	
4	WD50kW_Res_NA_SCE_C	0.050	-	-	-	0.0	0.0	0.0	0.0	0.1	0.1	0.1	0.1	0.1	0.1	0.1	
5	WD50kW_Res_NA_SCE_I	0.050	-	-	-	0.1	0.1	0.1	0.1	0.1	0.1	0.1	0.2	0.2	0.2	0.3	
6	WD50kW_Res_NA_SDGE_C	0.050	-	-	-	0.0	0.0	0.0	0.0	0.0	0.0	0.0	0.1	0.1	0.1	0.1	
7	WD50kW_Res_NA_SDGE_I	0.050	-	-	-	0.1	0.1	0.1	0.1	0.1	0.1	0.2	0.2	0.2	0.3	0.3	
8	FC500kW_Res_NG_PGE_C	0.000	-	0.1	0.1	0.1	0.1	0.1	0.1	0.1	0.1	0.1	0.2	0.2	0.2	0.2	
9	FC500kW_Res_NG_PGE_I	0.000	-	0.1	0.1	0.1	0.1	0.1	0.1	0.1	0.1	0.1	0.2	0.2	0.2	0.2	
10	FC500kW_Res_NG_SCE_C	0.000	-	0.1	0.1	0.1	0.1	0.1	0.1	0.1	0.1	0.1	0.2	0.2	0.2	0.2	
11	FC500kW_Res_NG_SCE_I	0.000	-	0.1	0.1	0.1	0.1	0.1	0.1	0.1	0.1	0.1	0.2	0.2	0.2	0.2	
12	FC500kW_Res_NG_SDGE_C	0.000	-	0.1	0.1	0.1	0.1	0.1	0.1	0.1	0.1	0.1	0.2	0.2	0.2	0.2	
13	FC500kW_Res_NG_SDGE_I	0.000	-	0.1	0.1	0.1	0.1	0.1	0.1	0.1	0.1	0.1	0.2	0.2	0.2	0.2	
14	Storage30kW_Res_NA_PGE_C	0.000	-	0.1	0.1	0.1	0.1	0.1	0.2	0.3	0.4	0.5	0.7	1.0	1.4	2.0	
15	Storage30kW_Res_NA_PGE_I	0.000	-	0.1	0.1	0.1	0.1	0.1	0.2	0.3	0.4	0.5	0.7	1.0	1.4	2.0	
16	Storage30kW_Res_NA_SCE_C	0.000	-	0.1	0.1	0.1	0.1	0.1	0.1	0.1	0.1	0.2	0.2	0.3	0.3	0.4	
17	Storage30kW_Res_NA_SCE_I	0.000	-	0.1	0.1	0.1	0.1	0.1	0.1	0.1	0.1	0.2	0.2	0.3	0.3	0.4	
18	Storage30kW_Res_NA_SDGE_C	0.000	-	0.1	0.1	0.1	0.1	0.1	0.1	0.1	0.1	0.2	0.2	0.3	0.3	0.4	
19	Storage30kW_Res_NA_SDGE_I	0.000	-	0.1	0.1	0.1	0.1	0.1	0.1	0.1	0.1	0.2	0.2	0.3	0.3	0.4	
20	WD1500kW_GNP_NA_PGE_C	1.500	-	-	0.0	0.0	0.0	0.1	0.1	0.1	0.1	0.1	0.2	0.2	0.3	0.4	0.5
21	WD1500kW_NR_NA_PGE_C	1.500	-	-	0.1	0.1	0.2	0.2	0.3	0.4	0.5	0.7	0.9	1.2	1.5	2.0	
22	WD1500kW_GNP_NA_PGE_I	1.500	-	-	0.0	0.0	0.0	0.1	0.1	0.1	0.1	0.2	0.2	0.3	0.4	0.5	
23	WD1500kW_NR_NA_PGE_I	1.500	-	-	0.1	0.1	0.2	0.2	0.3	0.4	0.5	0.7	0.9	1.2	1.5	2.0	
24	WD1500kW_GNP_NA_SCE_C	1.500	-	-	-	0.0	0.0	0.0	0.0	0.0	0.0	0.0	0.0	0.0	0.1	0.1	
25	WD1500kW_NR_NA_SCE_C	1.500	-	-	-	0.0	0.0	0.0	0.1	0.1	0.1	0.1	0.2	0.2	0.3	0.3	

Summary Stats per Unit

The summary stats per unit tab lists the net present value of the technology rebates, the TRC ratios and their levelized components, the STRC ratios and their levelized components, the PCT ratios and their levelized components, and the PAC ratios with their component costs and benefits. Note that in the example in Figure D-18, Total PA Rebate values are zero. When only one technology is run in the model, PAC results are not seen.

FIGURE D-18: SUMMARY STATS PER UNIT EXAMPLE

List of Technologies	MW per Unit	Total PA Rebates			TRC Ratios			TRC - Societal Benefits			TRC - Societal Costs			PCT Ratios		
		2014	2020	2024	2014	2020	2024	2014	2020	2024	2014	2020	2024	2014	2020	2024
FC1200kW_NR_NG_PGE_I	1.20	\$0	\$0	\$0	110%	114%	118%	\$1,887,318	\$2,100,490	\$2,312,248	\$1,719,161	\$1,847,103	\$1,962,280	94%	95%	98%
FC1200kW_NR_NG_SCE_I	1.20	\$0	\$0	\$0	111%	115%	120%	\$1,907,608	\$2,125,557	\$2,341,237	\$1,714,884	\$1,841,942	\$1,956,405	79%	77%	79%
FC1200kW_NR_NG_SDGE_I	1.20	\$0	\$0	\$0	113%	118%	122%	\$1,939,904	\$2,164,732	\$2,385,995	\$1,712,514	\$1,839,084	\$1,953,151	88%	87%	90%

Summary Stats Total

The Summary Stats Total tab lists the technologies and the total value of adoptions, rebates, and the TRC, PCT, and PAC ratios by aggregate technology grouping. The tab also includes graphics of the total adoptions by aggregate technology and the total TRC, PCT, and PAC ratios for the program over the 2014-2024 time periods.



FIGURE D-19: SUMMARY STATS TOTAL EXAMPLE

List of Technology Groups	Adoptions - MW			Total PA Rebates (\$000)			TRC Ratios			PCT Ratios			
	2014	2020	2024	2014	2020	2024	2014	2020	2024	2014	2020	2024	
Totals	0.1	0.6	2.0	\$0	\$0	\$0	69%	89%	105%	94%	116%	127%	
Res	0.0	0.0	0.0	\$0	\$0	\$0	N/A	N/A	N/A	N/A	N/A	N/A	
Wind	0.0	0.0	0.0	\$0	\$0	\$0	N/A	N/A	N/A	N/A	N/A	N/A	
Fuel Cell	0.0	0.0	0.0	\$0	\$0	\$0	N/A	N/A	N/A	N/A	N/A	N/A	
Storage	0.0	0.0	0.0	\$0	\$0	\$0	N/A	N/A	N/A	N/A	N/A	N/A	
NonRes	0.1	0.6	2.0	\$0	\$0	\$0	69%	89%	105%	94%	116%	127%	
Wind	0.0	0.0	0.0	\$0	\$0	\$0	N/A	N/A	N/A	N/A	N/A	N/A	
Fuel Cell	0.0	0.0	0.0	\$0	\$0	\$0	N/A	N/A	N/A	N/A	N/A	N/A	
Storage	0.1	0.6	2.0	\$0	\$0	\$0	69%	89%	105%	94%	116%	127%	
ICE	0.0	0.0	0.0	\$0	\$0	\$0	N/A	N/A	N/A	N/A	N/A	N/A	
ORC Engine	0.0	0.0	0.0	\$0	\$0	\$0	N/A	N/A	N/A	N/A	N/A	N/A	
Micro Turbine	0.0	0.0	0.0	\$0	\$0	\$0	N/A	N/A	N/A	N/A	N/A	N/A	
Gas Turbine	0.0	0.0	0.0	\$0	\$0	\$0	N/A	N/A	N/A	N/A	N/A	N/A	
List of Technologies	MW per Unit	2014	2020	2024	2014	2020	2024	2014	2020	2024	2014	2020	2024
Storage30kW_NR_NA_PGE_I	0.03	0.1	0.4	1.6	\$0	\$0	\$0	71%	91%	107%	74%	95%	112%
Storage30kW_NR_NA_SCE_I	0.03	0.0	0.1	0.2	\$0	\$0	\$0	67%	83%	98%	93%	138%	178%
Storage30kW_NR_NA_SDGE_I	0.03	0.0	0.1	0.2	\$0	\$0	\$0	68%	86%	101%	122%	189%	244%

Other Results Workbook Tabs

In addition to the tabs described above there are other tabs that supply data to this workbook. The template tab is used by the system to provide a place for the results to be placed after each technology combination is simulated. The system makes a copy of the template tab and renames it based on the name of the technology combination. The data from that run is copied into this new tab from the Results tab found in the CalcEngine. For every technology combination in the batch run one tab is created that holds the results for that technology combination. The number of tabs holding results will match the number of technology combinations found in the technology list in SGIPce.

Additional Workbooks

In addition to the workbooks described in this section there are numerous other workbooks found in the Inputs directory that contain data for the system. As this is a Quick Start Guide these additional workbooks are not described here. Please consult the other sections of the user guide for a complete description of these workbooks and how they are used by the system.

D.3 CHANGING INPUTS TO RUN SCENARIOS

This section is designed to show the user how to set up some basic scenarios by explaining the fields in the SGIPce Technology Description list. This section also highlights areas that the user may change manually for other scenarios that they may want to create. The SGIPce is set up to be very flexible with respect to adjusting inputs, but some inputs need to be changed manually to affect the desired impact. This section will attempt to go through these concepts and make it clear how and where inputs can be changed.



Changing Parameters in the Technology Definitions Table

When starting SGIPce, the user goes through the steps of setting up the Global Assumptions and the “Buttons”. Please refer to Section 2 in this User Guide for information about using the fields in Global Assumptions and the functions of the buttons.

With respect to the Technology Definitions table in SGIPce, this table has been set up to allow the user to change the way the system runs each technology (e.g., does it receive an incentive or not). Scenarios may be set up by the user utilizing the fields in this table.

This section discusses the various fields found in the Technology Definition table. It is the intent of this section to present some of the variables that can be changed in the system. Please refer to other sections of the User Guide and the SGIPce Report for an explanation of these variables, their values, and the cost effectiveness framework. Figure D-20 shows an example of information contained in the Technology Definition table.

FIGURE D-20: TECHNOLOGY DEFINITIONS TABLE

Technology Definitions												
Run Number	Run Technology Flag	Technology Name	Sector	Fuel Type	Utility	Climate Region	Utility Rate	Financing Opti	Rebate Ty	Progress Ratio	Technology Scenario Descripto	Expected Capacity Factor
1	No	Gas Turbine (<= 3 MW)	Commercial	Natural Gas	PG&E	Coast	A10TOU	Debt/Equity	None	NA	CapFac	0.8
2	No	Gas Turbine (<= 3 MW)	Commercial	OnSite Bio-Gas	PG&E	Coast	A10TOU	Debt/Equity	None	NA	CapFac	0.8
3	No	Gas Turbine (<= 3 MW)	Commercial	Direct Bio-Gas	PG&E	Coast	A10TOU	Debt/Equity	None	NA	CapFac	0.8
4	No	Gas Turbine (<= 3 MW)	Commercial	Natural Gas	PG&E	Inland	A10TOU	Debt/Equity	None	NA	CapFac	0.8

Please note that there are some specific rules about what may and what may not be edited in the SGIPce workbook. Microsoft Excel’s protection capabilities were not implemented in the workbook because of the restrictive nature of this capability. Please make note of the fields that are indicated as not editable. Changes to these fields will very likely cause a malfunction in the system.

Changing Technology Definitions List

- » The Technology Definitions list is found on the front page of the SGIPce workbook. The system will open to this page automatically each time you open the workbook.
- » The Technology Definitions list is a list of SGIP technologies investigated in the model.
 - > No lines may be added to this list.
 - > No changes to the fields in this list should be made, other than those mentioned here and in Section 4.
- » The columns are color-coded.
 - > If the columns alter between green and white then they are editable by the user. For example, changes can be made to Utility Rate, Financing Option, Rebate Type, etc.
 - > If the columns are solid green then they must not be changed. In this case, changes cannot be made to Technology Name, Sector, Fuel Type, Utility, etc.
- » The Technology Definitions list may be filtered.
 - > The down-arrows in each column header allow the user to filter on specific lines in the list.

- > Please do not confuse these down-arrows with the ones that show up when a cell is selected. These arrows are explained later in this section.
- > It is strongly suggested that the *Clear Filter* button be pressed and the reset buttons be pressed before setting up a new run. Please see Section 2 for more detail on this.
- > The filtering system allows the user to select any or all lines based on the values found in the columns.
 - For example, the filter on the Technology Name column lists all technologies available in the list. To hide technologies in the list simply clear the checkboxes next to the technology names to be hidden and select *Ok*. The unchecked technologies will no longer be visible until the filter is clear.
- > The filtering system is cumulative.
 - The user may combine any combination of filters in the list to limit the list to the specific group of lines desired.
 - Filtering a technology so that it is hidden is not equivalent to the technology being eliminated from a cost effectiveness run. Inclusion or exclusion from a run is solely determined by the “Run Technology Flag”.
 - Once they are done with that set of filters they can press the *Clear Filters* button and all lines in the list will reappear.

Fields in the Technology Definition List

- » Identifier and Scenario Fields in the Technology Definitions list
 - > The columns that are green are identifier fields and **should never be edited**.
 - These fields include Run Number, Technology Name, Sector, Fuel Type, Utility, Climate Region and Error Condition.
 - *Error Condition* should **never** have a value in it. If anything is seen in this column then the list has been edited incorrectly and needs to be restored before continued use. The best way to solve this situation is for the user to get a new copy of *SGIPce.xlsx* from the compressed file that was downloaded.
 - > The columns that alternate green and white are editable by the user.
 - These fields include Run Technology Flag, Utility Rate, Financing Option, Rebate Type, Progress Ratio, Technology Scenario Description, and Expected Capacity Factor.
 - These fields are considered Scenario fields.
- » Using Scenario Fields
 - > Most of the Scenario fields have drop-downs containing the allowable values for the field. These values must be used for the system to function properly.
 - Please **do not** confuse these drop-down arrows with the filters arrows found in the column headers at the top of the table. The filter arrows do not perform the same function as the drop-down arrows that show up when you enter a field to select a new value.
 - The drop-down arrows are only visible if the cursor is in a Scenario field in the non-column header row. The filter arrows are always visible in the column header row.
 - > Judicious copy and paste may be used when setting up these fields.

- It is okay to copy a value from one cell and paste it into one or more cells below that should take on the same value, but please use care when doing this.
 - *Utility Rate* would be an exception to this since the rates vary by utility. Care must be taken when setting this field.
- Paste will only put the copied value in the visible cells in the table
 - For example: after filtering the list the user may select *Yes* for the first cell in *Run Technology Flag* and copy that value to all other visible lines in the filter list for that column. The values in the hidden cells will not be changed
- > The following list of fields is for use in user-defined scenarios.
 - *Run Technology Flag*
 - Identifies the technology line the user wants in their scenario.
 - *Yes* indicates include in scenario.
 - *No* indicate do not include in scenario.
 - *Utility Rate*
 - A line's Utility Rates keys off the value of Utility and Sector to present the allowable values for the field in the dropdown.
 - There are two representative rates defined for each Utility and Sector.
 - These rates were selected to be representative of the most likely rates encountered by the customers in the service territory.
 - While adding new rates is possible, the system is not setup in a way for the user to do this on their own. A request for this should be submitted to the CPUC for evaluation and possible addition to the system.
- > *Financing Option*
 - Each technology line may be run with either Debt/Equity financing or Power Purchase Agreement (PPA)/Commercial financing.
 - Debt/Equity financing uses 60% equity for the Non-residential sector and 40% equity for Residential and Government/Non-profit sectors by default.
 - The Debt/Equity distribution can be changed by the user in the *SGIPce_Inputs_Global.xlsx* workbook on the tab named *Global_Financing*.
 - Row 94, columns D, E, & F hold the default values.
 - Be sure to make a copy of the original workbook so that you can go back to the default values if desired.
 - PPA/Commercial Financing starts with a value of 60% for percent equity financed, but finds the actual value for equity financing using a goal seeking routine that sets to zero the following equation:
 - $(\text{Cash Flow Available for Debt Service over the debt term}) - (\text{Total Cash Flow Available for Debt Service required})$.
 - The equation of the difference may be viewed in the Calculation Engine in the LCOE ProForma worksheet on Row 141, Column C.
 - If a value cannot be found for a given technology then the default value is used for that technology.

- **Please note that setting a technology to run under PPA/Commercial financing significantly increases the run time due to the need for the goal seek functionality in Microsoft Excel**
- > **Rebate Type**
 - There are three values to select for this field (i.e. *None, PBI, EPBB*):
 - *None* tells the system that no rebates should be paid for the given technology line item.
 - *PBI* distributes the rebate received by the consumer over five years and is based on the level of production during those five years.
 - *EPBB* is an upfront rebate that is paid in the first year of operation.
 - The values for these rebates are set in the individual technology workbooks (e.g. *SGIPce_Inputs_Tech_FC1200kW_NR_NG.xlsx*) found in the Inputs folder under SGIPce.
 - Look in the AnnualInputs tab of each technology workbook on line 35 for EPBB and line 39 for PBI.
 - **Changes to these values may be made in these workbooks and saved for use by the system. Please be sure to make a copy of the workbook as a backup to return to the default values if needed.**
- > **Progress Ratio**
 - The progress ratio is an input to the learning curve used to predict system prices over time.
 - Default values for progress ratio have been estimated as a part of developing this system, but the user may substitute their own values for this parameter if desired.
 - Allowable values for Progress Ratio in the Technology Definition Table fall between greater than zero and 1. Values outside this range will cause an error condition.
 - The actual value used may be viewed in the calculation engines on the Cover tab in the cell labeled Progress Ratio Override.
- > **Technology Scenario Description**
 - This field is used to help identify the technology level scenario that is being run.
 - It is informational in nature only.
 - The value of this field is presented on the cover page of the calculation engines labeled Technology Scenario Descriptor.
 - This field must be manually changed.
 - There are currently three allowable values:
 - *NA* indicating that neither of the two values below has been changed for the current technology.
 - *CapFac* indicating that a user defines Expected Capacity Factor has been defined for this technology line item.
 - *ProgRatio* indicating that a user defined value for the progress ratio has been defined for this technology line item.
 - Using this field is purely at the discretion of the user. Care should be taken to assure that it is set properly given the scenario defined, if used.

> *Expected Capacity Flag*

- The adjustment to the default capacity factor has been implemented as an adjustment to the default production curve defined for each technology.
- There are two different types of inputs allowed in this field:
 - The word *Actual* placed in this field tells the system to use the default production curves as they are stored in the technology workbooks.
 - A decimal value that is greater than zero and less than or equal to 1 ($0 < \text{adjustment} \leq 1$) may be used to adjust the default production curve so that it produces an average annual capacity factor of the user defined value.
 - Note that limits are necessary when making this adjustment. Because it is possible to exceed 1.0 in any given hour to obtain the Expected Capacity Factor, a limit on the hourly values is necessary to prevent extreme values. The hourly values of the production curves are limited to no more than 1.05 to mitigate this issue.
 - Because of this limit the Expected Capacity Factor may not be fully attained for some technologies.
 - The final calculated value for any given technology run may be viewed in the individual calculation engines if they are saved. On the Technology tab in these workbooks on Row 7, Col D the adjusted capacity factor is presented.
 - On the Cover tab of each calculation engine the Expected Capacity Factor, set by the user, is presented for review.

D.4 MAKING MANUAL CHANGES TO INPUTS

There are other inputs that can be changed in the model, but no formal method of changing them has been developed. As the user looks through the comments made above, they will see more closely the structure of the model and how the inputs are stored. This section discusses a few potential inputs that might be of interest to the user for further analysis. The section will show the user how to manually make changes to a few of these inputs. As the user discovers more of these inputs, it may be desirable to more formally develop a method to change inputs as part of the scenario runs. Requests for these changes should be forwarded to the CPUC for evaluation and possible inclusion into future versions of this software. One example of a possible concept that must be manually changed has to do with sites that use onsite biogas. This change along with other inputs is discussed next.

Onsite Biogas

SGIPce is set up to handle the capital costs and CO₂ benefits for onsite biogas (OSBG) projects in two distinct ways, depending on the size of the project. OSBG-powered projects greater than 500 kW in size are assumed to be associated with facilities where biogas is already captured. Examples include landfills and waste water treatment facilities. These facilities are required by environmental and safety regulations to capture and flare methane generated at the site. In these instances, SGIPce does not allocate capital costs to a biogas digestion system as these systems are assumed to already be in place. Additionally, SGIPce does not allocate CO₂ benefits associated with capture of methane in these projects



as the biogas is assumed to be flared. As such, the power generation project cannot be credited with capturing methane that is already being captured and sent to a flare as a “baseline” condition.

For OSBG-powered projects equal to or smaller than 500 kW and which are located at dairies, we have assumed biogas is not already captured. Unlike landfills and waste water treatment facilities, dairies are not currently required to capture and treat the biogas produced from open lagoons. As a result, the methane contained in the biogas is vented to the atmosphere, thereby acting as a potent GHG. Consequently, OSBG-powered projects for dairies incur the cost of installing a digester system in order to capture the biogas that can then be used to power the electricity generator. Similarly, these facilities are credited with CO₂ benefits associated with capture of methane. In these cases, SGIPce allocates the project with the increased capital cost associated with the biogas digester system but also allocates the project with the resulting CO₂ benefits.

The way this is implemented in the system is through a toggle in the technology workbooks. In the technology workbooks with the suffix *_OSBGas* the user can find a field on the Constants tab labeled “Is this technology installed at a Dairy.” This field is set to *Yes* if the technology is to be estimated as if it was installed at a Dairy and *No* if it is not. The effect of setting this to *Yes* is to change the value of *Emissions Factor – CO₂*, also found on the Constants tab, and to add the cost of the Anaerobic Digester to the Other Capital Costs (Other Prices not in System) found on the *AnnualInputs* tab on Row 14, Columns D, E, & F.

As mentioned above, changing this value is a manual process. Each onsite biogas technology workbook must be change separately if the user wants to change the status of this field. Please be sure to make a copy of the workbooks being changed so that the default values can be restored if desired.

Changes in Capital Costs

Manual changes to the concepts that follow may all be done on the same worksheet. The worksheet in question can be found in each technology workbook in the Inputs folder under SGIPce.

The inputs to Capital Costs (i.e., System Prices) are found on Rows 5 through 8 of the *AnnualInputs* worksheet in each technology workbook. The formula used to calculate these cost incorporates historical information about global capacity found in Row 6 and historical information about system prices found in Row 8. The fields that are considered user input are yellow in color and are columns C, D, E, & F. These fields may be changed by the user as desired to affect the level of Capital Cost used by the system for the selected technology. The other columns in these rows are the Learning Curve formulas and may not be changed by the user.

Column C, Row 6 is an annual escalation rate of global capacity. This value is applied to the 2009 input, which is expanded out from 2014 to 2024 in the worksheet. The user may make adjustments to this value and to the historical values found in columns D, E, & F. Only these four numbers are retrieved by SGIPce to calculate the total stream of Capital Cost. The other values in this row are presented to the user for review only.



Column C, Row 8 is the Progress Ratio used by the Learning Curve formula for estimating Capital Cost over time. As mentioned in the previous section, this value may be overridden by the user in the SGIPce Technology Definitions table. Columns D, E, & F of Row 8 hold the historical values of Capital Costs observed in 2011 to 2013. These values may be updated by the user if desired. The values from 2014 to 2024 use the Learning Curve formula and reference both the global capacity and historical system prices and may not be changed by the user. These values are presented for review only in this worksheet.

Also note that there may be references to other cells and worksheets in the historical values mentioned above. The user should spend some time reviewing the information developed on the worksheets referenced before making changes to these values.

Changing O&M Costs

O&M Costs may also be found on the AnnualInputs tab of each of the technology workbooks that accompany SGIPce. Row 19 holds the inputs to the O&M cost calculation and the historical values may be changed by the user as desired.

Once again there are four cells that may be edited by the user. Row 19, Column C holds the rate at which the 2011 historical value is escalated from 2014 through 2024. Columns D, E, & F hold the observed values for O & M costs from 2011 through 2013. If different historical values are appropriate then they can be changed here.

As mentioned above, these cells may contain references to other worksheet in the technology workbook. The user would be well served to evaluate the information on the referenced worksheet before making changes.

Changing the Directed Biogas Adder

The Gas Price Adder for Directed Biogas is also found on the AnnualInputs worksheet of the technology workbooks. Row 24 contains the values for this input and the historical values may be edited by the user.

As with the O&M Costs described above, there are four cells that may be edited by the user. The cell in Column C is the escalator to be used to calculate values from 2014 through 2024 using the 2013 historical input. Columns D, E, & F are the observed values for this input that are used by SGIPce to calculate all values for this input.

Once again, these cells may contain references to other worksheet in the technology workbook. The user should review these inputs on the referenced worksheet before making changes



Finally

As can be seen in this section and others, all of the inputs to the SGIPce system can be observed and changed if desired. Investigation of the workbooks found in the Input folder will help the user to understand what goes into the model and spur thoughts about what could be changed. This section shows ways of making changes to the obvious inputs. The same can be done to other inputs as well. Care must be taken in doing so, however.

It cannot be stressed enough that if the user wants to change input values used by the SGIPce, they should make backups of the workbooks to enable a return to their original states. Also, if changes are made to the input files, it should be noted that it may be very difficult for the developers to look at what was done and repair it. Please make changes incrementally and test frequently to be assured that SGIPce still works before proceeding to the next change. This insures that the user can always get back to the last change that was successfully made and begin again with the next change. Good luck!

APPENDIX E EQUATIONS AND METHODS IN COST EFFECTIVENESS TESTS

Section 5 provided a description of the structure and operation of the SGIPce model. This appendix provides a more detailed look at the mechanics and specific equations used in calculating the different test results and how these are treated by the model.

E.1 OVERALL APPROACH

Tables 4-1 and 4-2 in Section 4 provided a summary of the different cost and benefit components used in each of the cost tests. In this section, we describe in more detail each of the cost and benefit components in the different cost tests and how they are used in calculating benefit-to-cost ratios. Note that this section focuses primarily on the process by which the cost and benefit components are calculated in the model. We sometimes refer to summary values of the various components. However, quantitative values for individual components and subcomponents can be found in the 2014 SGIPce model (in the technology input workbooks) and in Appendix A of this document.

Nomenclature Used in Equations

Within the model, the cost tests can be run on individual technologies or on mixes or portfolios of technologies. The SGIP can be viewed as a portfolio of distributed generation and storage technologies with specific rules of operation and financial requirements. In the mathematical expressions given below, we use specific nomenclature and subscripts to identify technologies, references of time, discount rates, etc. Table E-1 lists out the different nomenclature we use in the cost and benefit equations.

TABLE E-1: NOMENCLATURE USED IN COST & BENEFIT EQUATIONS

Term	Factor or Subscript
SGIP technology	<i>i</i>
Year being examined	<i>t</i>
Month being examined	<i>m</i>
Hour being examined	<i>h</i>
Lifetime of technology (total years)	<i>T</i>
Total months of operation	<i>M</i>
Region (coastal or inland)	<i>r</i>
Discount rate	<i>d</i>
Tariff rate	<i>p</i>
Total number of applicable tariffs	<i>P</i>

Participant Cost Test

The Participant Cost Test (PCT) evaluates the value of the participant’s involvement in a program. It calculates the economic impact of the participant’s use of technologies by taking into account the cost



of the technologies, operating expenses, bill savings, rebates, tax credits and other costs or benefits. The PCT is a conservative measure of the economic impact to participants. The PCT cannot capture the monetary value of intangibles that may, nonetheless, be important to participants. For example, it cannot quantify a monetary value of the “greenness” of a technology or its attractiveness to participants who want to engage “cutting edge” technologies. Given those caveats, the PCT provides important information to both participants and program designers. Participants can use the results of the PCT to identify which technologies provide them the most cost effective results. Program planners can use the PCT to determine the effect of changing incentive levels of different technologies on participant cost effectiveness. Comparisons between the effects can provide planners with insights on appropriateness of different incentive levels.

The PCT calculates the ratio of the benefits provided to the participant to the cost incurred by the participant:

$$\text{Participant Benefit-Cost Ratio} = (\text{Participant Benefits} / \text{Participant Costs})$$

Participant Costs

Participants have to purchase and install SGIP systems, arrange financing as needed, maintain SGIP system operation and buy fuel, as necessary.¹ Participants may also have to pay to be interconnected into the electricity system, and may have to pay fees to the utility if they require backup power or capacity.

Table E-2 is a listing of participant costs used in the SGIP evaluation.

TABLE E-2: PARTICIPANT COSTS

Costs
Costs of SGIP system, interconnection, air pollution emission controls
Operation and maintenance (O&M) and fuel ²
Removal costs (less salvage)
Non-bypassable charges (competition transition charges, DWR, Nuclear decommissioning, etc.)
Standby charges

¹ AES systems using batteries do not purchase “fuel” but need to charge the batteries. Wind and waste heat to energy systems do not need to purchase fuel.

² Note that fuel costs and O&M costs are accounted for separately.



SGIP SYSTEM COSTS

Participant costs can be expressed as three main components:

$$ParticipantCosts_i = Equity_i + Finance_i + O\&MCosts_i$$

Equity_i is the cost of the technology (i) paid for at the time of installation, including the SGIP system, interconnection costs, emission controls, etc.

SGIP system costs vary by technology and consist of different components. Individual SGIP system costs are presented in the 2014 SGIPce model (in the technology input workbooks) and in Appendix A. Where air pollution controls are required, these cost estimates are contained in the SGIP system costs.

When SGIP systems are interconnected into the electrical grid, there is typically an interconnection study conducted and a cost associated with the interconnection. In some SGIP systems, the cost of this study is not paid by the participant. However, upgrades required on the electrical system as a result of the installation of the SGIP system are paid for by the participant. There is substantial variation in SGIP interconnection costs.³ The interconnection process and cost uncertainty of SGIP interconnection is actively addressed in the CPUC Rule 21 interconnection proceedings.⁴

Due to the large uncertainty in interconnection costs, we do not include interconnection costs as a component in the model.

There are instances where companies pay for the technology using their own financial resources, but more often the project is financed. If the equipment is financed, the term Finance_i represents the repayment of debt and the sum of interest paid over the life of the loan. O&MCosts_i reflects the O&M costs incurred over the life of the technology including fuel costs.

SGIPce is a levelized cost model and we use net present value (NPV) to establish a common basis among the costs. The present value of the finance cost is defined as:

$$Finance_i = \sum_{t=1}^T \frac{Finance_t}{(1+d)^{t-1}}$$

T is the lifetime of the technology (typically 20 years), t denotes the year in question, and d is the discount or interest rate. The participant discount rate depends on the market segment. We assume

³ For example, in the interconnect proceeding, PowerTree indicates interconnection costs may represent up to 36% of the project cost and references interconnection costs ranging from \$150 to \$50,000. See December 4, 2014 Workshop: on the Development of Cost Certainty Policies for the Interconnection Process at <http://www.cpuc.ca.gov/PUC/energy/rule21.htm>

⁴ See CPUC open interconnection proceeding R.11-09-011 at: <http://www.cpuc.ca.gov/PUC/energy/rule21.htm>



participants acquire financing to cover 40% of the cost of the technology at market interest rates and use a finance period of 80% of the technology life.

Finance costs can be broken down further into debt and interest costs and expressed as follows:

$$Finance_i = \sum_{t=1}^T \frac{Debt_t + Interest_t}{(1+d)^{t-1}}$$

$Debt_t$ is the yearly debt payment and $Interest_t$ is the yearly interest payment. These costs are used in establishing annual costs for each of the technologies.

SGIP OPERATION AND MAINTENANCE COSTS AND FUEL COSTS

Aside from equity investment in SGIP technologies, participants also incur O&M costs. Variable operating costs typically consist of labor for operating the system, additional electrical purchases for auxiliary loads associated with the SGIP system (e.g., motor loads for providing water for water jackets or cooling air), and chemicals for use in air pollution control systems. Maintenance costs include periodic overhauls or replacement of system components (e.g., replacing a portion of the stack on a regular basis in the case of fuel cells). O&M costs used in this study are based on interviews with equipment manufacturers, project developers, host sites, and secondary data (i.e., literature).

When expressing incurred O&M costs on a net present value basis, we express the present value of O&M costs over the lifetime of the technology by:

$$O \& M Cost_i = \sum_{t=1}^T \frac{O \& M Cost_{it}}{(1+d)^{t-1}}$$

Fuel costs represent an on-going cost of some SGIP projects. In this evaluation, fuel costs are confined to purchases of natural gas or directed biogas. We use the CEC's natural gas price projections for estimating IOU-specific natural gas prices in the future⁵ and Energy Information Administration (EIA)'s annual energy outlook for Henry Hub natural gas price projections.⁶

Annual fuel costs are calculated using the appropriate fuel prices and the amount of natural gas or directed biogas consumed by the SGIP system based on:

$$FuelCost_t = \sum_{m=1}^M ThermsUse_{mt} PriceGas_{mt}$$

$ThermsUse_{mt}$ is the monthly usage of natural gas by the SGIP system, where m refers to the specific month in year t. $PriceGas_{mt}$ is the monthly non-core customer retail price of natural gas. Fuel costs are summed over the total M months of the operating lifetime of the technology. In those instances where

⁵ See: <http://www.energy.ca.gov/2009publications/CEC-200-2009-012/CEC-200-2009-012-SF-REV.PDF>

⁶ See: [http://www.eia.gov/oiaf/aeo/pdf/0383\(2010\).pdf](http://www.eia.gov/oiaf/aeo/pdf/0383(2010).pdf)



the SGIP system uses directed biogas, an additional cost per therm is added to the price of natural gas to account for the purchase of directed biogas. For technologies fueled by onsite biogas, there are no fuel costs. Systems fueled by onsite biogas pay higher installation costs for collection and clean-up of the biogas. These applications also have higher O&M costs associated with maintenance of the system.

We then calculate present value of the fuel costs for any individual SGIP technology (i) based on the appropriate customer segment discount rate (d) by summing annual fuel costs for each year (t) over the expected lifetime (T) of the technology:

$$FuelCost_i = \sum_{t=1}^T \frac{FuelCost_{it}}{(1+d)^t}$$

SGIP SYSTEM REMOVAL COSTS

At the end of the useful life of a SGIP technology, the participant faces removal of the SGIP system. Removal costs may consist of labor used to remove the equipment, fees for disposal of materials that have no useful economic value, and remediation of the site. These costs can vary significantly by technology and by each individual site. In addition, due to the small footprint of SGIP technologies, removal costs can be insignificant relative to the upfront investment. We assume that SGIP systems are operated for up to 20 years and their present value removal costs are negligible.

Table E-3 is a summary listing of the installed costs of the different SGIP systems evaluated in this study at nominal system sizes and their associated O&M costs. Note in this instance that the O&M cost reference does not include fuel costs.

TABLE E-3: SGIP TECHNOLOGY SYSTEM COSTS & O&M COSTS (2014 BASIS)

Technology	Fuel/Energy Resource	SGIPce 2014 Nominal System Size (kW)	2014 SGIPce Costs	
			Installed Cost (\$/kW)	O&M (\$/ kWh)
Wind: Small	Wind	1,500	\$2,280	\$0.0100
Wind: Large	Wind	50	\$5,774	\$0.0130
Fuel Cell - Electric Only	Natural Gas	500	\$7,500	\$0.0400
	Onsite Biogas		\$9,028	\$0.1900
	Directed Biogas		\$7,500	\$0.0400
Fuel Cell- CHP: Small	Natural Gas	500	\$7,500	\$0.0400
	Onsite Biogas		\$9,028	\$0.1900
	Directed Biogas		\$7,500	\$0.0400
Fuel Cell- CHP: Large	Natural Gas	1,200	\$4,500	\$0.0400
	Onsite Biogas		\$5,409	\$0.1100
	Directed Biogas		\$4,500	\$0.0400
Gas Turbine: Medium	Natural Gas	2,500	\$2,932	\$0.0110
	Onsite Biogas		NA	NA
	Directed Biogas		NA	NA
Gas Turbine: Large	Natural Gas	7,000	\$2,784	\$0.0147
	Onsite Biogas		NA	NA
	Directed Biogas		NA	NA
Microturbine	Natural Gas	200	\$3,204	\$0.0258
	Onsite Biogas		\$4,649	\$0.0558
	Directed Biogas		\$3,204	\$0.0258
IC Engine: Small	Natural Gas	500	\$2,553	\$0.0235
	Onsite Biogas		\$3,207	\$0.0535
	Directed Biogas		\$2,553	\$0.0235
IC Engine: Large	Natural Gas	1,500	\$2,018	\$0.0160
	Onsite Biogas		\$2,672	\$0.0460
	Directed Biogas		\$2,018	\$0.0160
Waste Heat to Power	NA	450	\$3,637	\$0.9940
Energy Storage: Small	NA	30	\$3,044	\$0.0283
Energy Storage: Large	NA	5,000	\$3,082	\$0.0749

PARTICIPANT NON-BYPASSABLE CHARGES AND STANDBY CHARGES

When utility customers self-generate electricity, they reduce some, if not all, of the need for services from the utility. In essence, the customer acts as though it is “departing” the electricity system. This reduction in service means utilities lose the ability to recover obligated costs that are usually recovered



from all served customers.⁷ In order to recoup these cost obligations, utilities are allowed to bill self-generating customers with departing load charges (DLCs). These charges are also known as “non-bypassable” charges or cost responsibility charges (CRCs). CRCs include a number of obligations that are embedded in utility costs such as Department of Water (DWR) bond charges or DWR power charges, public purpose program charges (PPPC), nuclear decommissioning (ND) costs, Energy Cost Recovery Charge (ECRC),⁸ New System Generation Charge (NSGC), competition transition charges (CTC),⁹ and historic procurement charges (HPCs).¹⁰

Non-bypassable charges are applied to customer bills and assessed based on the amount of electricity consumed from the grid. However, participants installing onsite SGIP technologies not eligible for an NEM tariff are required to pay certain non-bypassable charges both for electricity produced and consumed onsite.

Table E-4 provides representative non-bypassable charges included in electric rates from each of the three electric IOUs. Taking into account the exemptions specified in Table 4-14 in Section 4, we calculate annual non-bypassable charges for each technology.

TABLE E-4: REPRESENTATIVE NON-BYPASSABLE CHARGES

Utility	PG&E		SCE		SDG&E	
Tariff	E-19 TOU	A-10 TOU	GS2-TOU	GS8-TOU	AL-TOU	A6-TOU
DLCs						
PPPC	0.001201	0.01265	0.01062	0.00974	0.01177	0.00639
CTC	0.00136	0.00167	NA	NA	0.00123	NA
ND	-0.0003	-0.0003	0.0004	0.00043	0.00046	0.00044
ECRC	-0.00154	-0.00154	0.00024	0.00024	NA	NA
NSGC	0.00267	0.00267	0.00538	0.00974	0.00023	0.0023
DWR-BC	0.00513	0.00513	0.00513	0.00513	0.00513	0.00513

Note:

- PPPC is public purpose program charges
- CTC is competition transition charges
- ND is nuclear decommissioning
- ECRC is Energy Cost Recovery Charge
- NSGC is New System Generation Charge
- DWR-BC is Department of Water-Bond Charge

⁷ These cost obligations stem from a combination of legislative decisions and decisions made by the CPUC and were deemed to be charges that should be borne by all ratepayers.

⁸ Prior to March 1, 2005, the ECRC was referred to as Regulatory Asset Charges.

⁹ CTCs represent costs borne by the utilities in moving from a regulated to deregulated market.

¹⁰ The DWR Power Charge has long since been replaced by the Power Charge Indifference Adjustment (PCIA) charge. PG&E also includes an Energy Cost Recovery Charge (ECRC) and all three IOUs include a New System Generation Charge (NSGC).



Customers who self-generate typically are not able to meet all their electricity needs 100% of the time. For example, a self-generation system may encounter unexpected operational problems that cause it to go out of service or have reduced output. Similarly, the customer may encounter higher than expected load, exceeding the generating output of the self-generation system. In those instances, the utility acts as a “standby” generation resource. Utilities charge customers who contract for these services “standby” charges. In instances where standby charges are known, we include them as costs in the PCT. Representative standby charges are discussed in Section 4.

Participant Benefits

Participant benefits include electricity bill savings, CHP gas bill savings, rebates and incentives, renewable energy credits (REC) for green technologies, monetary benefit for net reduction in CO₂,¹¹ market transformation effects,¹² and state and federal tax savings. For qualifying SGIP systems, benefits also include NEM bill credits and certain exemptions (from standby charges, non-bypassable charges, and interconnection fees).

Table E-5 is a listing of the benefits allocated to participants.

TABLE E-5: PARTICIPANT BENEFITS

Benefits
Electricity bill savings
CHP gas bill savings
Rebates/Incentives
REC credits
Environmental benefits (limited to avoided CO ₂ emissions)
Market transformation effects (e.g., lower future capital costs)
Tax credits and depreciation
NEM bill credits
Standby charge and non-bypassable charge exemptions
Utility interconnection fee exemption for qualifying NEM systems

Participant benefits vary significantly by technology. For example, incentive levels vary by technology, as do electricity and gas bill savings. In general, we can sum participant benefits for each type of technology *i* by the following equation:

¹¹ Participants who meet the auction requirements and can verify net negative reductions in CO₂ emissions can sell the “carbon credit” through California’s cap and trade program.

¹² While participants may benefit from transformation of California’s DER market in a variety of ways (e.g., reduced time to market, increased expansion of supply chains, lowered capital costs, etc.), we focus on reductions of capital costs in the future due to learning curves for quantifying market transformation effects.



$$ParticipantBenefits = RedElecBills_i + ValDispFuels_i + Inc_i + IncO_i + TC_i + TB_i$$

RedElecBills_i represents reduced electricity bills, ValDispFuels_i represents the value of displaced fuels, Inc_i represents incentive provided by the SGIP, IncO_i represents incentives from other programs, TC_i represents federal and state tax credits, and TB_i represents other tax benefits.

ELECTRICITY BILL SAVINGS

RedElecBills_i represents the electric bill savings for SGIP technology i and is the sum of reductions in energy charges (RedEnChg_i) and reductions in demand charges (RedDemChg_i) for the technology:

$$RedElecBills_i = RedEnChg_i + RedDemChg_i$$

Annual reductions in energy charges are based on hourly values and calculated as:

$$RedEnChg_{it} = \sum_{p=1}^P \sum_{h=1}^{8760} \Delta kWhOnSite_{ipt} EnergyRate_{pht}$$

Similarly, annual reductions in demand charges are calculated as:

$$RedDemChg_{it} = \sum_{p=1}^P \Delta kWOnSite_{ipt} DemChg_{pt}$$

In these calculations, $\Delta kWhOnSite_{ipt}$ and $\Delta kWOnSite_{ipt}$ indicate reductions in onsite energy use and billing demand at year t for technology i, respectively. EnergyRate_{pht} and DemChg_{pt} reflect the prevailing energy and demand charges for customers based on the tariff rate p and summed over the total number of applicable rates (P).

GAS BILL SAVINGS

By recovering waste heat from the onsite generator, CHP systems can help meet onsite thermal energy needs. This recovery and use of waste heat displaces the need for the participant to purchase boiler fuel (typically natural gas). The value of the gas bill savings associated with thermal energy use at customer sites with CHP systems is represented by ValDispFuels_i.

We calculate the annual value of displaced fuels as:

$$ValDispFuels_{it} = DisTherms_{it} PGas_t$$

DisTherms_{it} represents the amount of fuel displaced for technology i in therms and PGas_t is the price of natural gas for non-core customers in year t.

The value of displaced fuels for CHP applications is the present value of the stream of future cash flows for technology i for each individual year t, summed over the lifetime T of the technology and using the discount rate d for the applicable market segment:



$$ValDispFue \quad ls_i = \sum_{t=1}^T \frac{ValDispFue \quad ls_{it}}{(1+d)^{t-1}}$$

INCENTIVES AND CREDITS

Participants in the SGIP receive SGIP-specific incentives. However, qualifying SGIP systems may receive a variety of other incentives and credits. We value the SGIP and other incentives and credits by:

$$Inc_i + IncO_i + TC_i + TB_i$$

Inc_i represents SGIP incentives for technology i , $IncO_i$ reflects other incentives including REC credits, TC_i is the federal ITC, and TB_i is state and federal tax savings associated with the SGIP technology participating in the SGIP.

Incentives

SGIP incentives are valued for each technology and the appropriate year in accordance with the SGIP Handbook. Specific incentive values for each SGIP technology were discussed in Section 4 and provided in Table 4-9 through Table 4-11.

Renewable Energy Credits

RECs represent the environmental and renewable attributes of renewable electricity. An REC can be sold either "bundled" with the underlying energy or "unbundled", as a separate commodity from the energy itself, into a separate REC trading market.¹³ Customers who install green technologies that qualify for REC retain ownership of the REC and can receive value for the REC.¹⁴

An REC is based on the amount of electricity generated by the qualifying facility. In general, one REC is generated for every megawatt-hour of generated renewable energy. REC prices depend on a number of factors, including the technology, the vintage (year in which it was generated), the volume purchased, the region in which the generator is located, whether they are eligible for certification, and whether the RECs are bought to meet compliance obligations or serve voluntary retail consumers.¹⁵ Solar RECs tend to be priced higher than non-solar RECs.¹⁶ Due to the uncertainty in non-solar REC prices, we valued non-solar RECs at \$0.035 per kWh over the forecast period, unless otherwise noted.

¹³ Definition from CPUC website. See: <http://www.cpuc.ca.gov/PUC/energy/Renewables/FAQs/05REcertificates.htm>

¹⁴ Customer ownership of REC for self-generating customers was decided by the CPUC in Decision D.07-01-018. See: http://docs.cpuc.ca.gov/PUBLISHED/FINAL_DECISION/46213.htm

¹⁵ U.S. Department of Energy, Green Power Markets website. See: <http://apps3.eere.energy.gov/greenpower/markets/certificates.shtml?page=5>

¹⁶ SREC prices in Delaware ranged from a high of \$300/REC to a value of \$65/REC in June 2014. See: http://www.sretrade.com/srec_markets/delaware



Environmental Benefits

Some SGIP technologies can result in net negative emissions of GHG emissions. For example, SGIP technologies that capture and use onsite biogas that would otherwise be vented to the atmosphere can result in net negative CO₂ emissions.¹⁷

California has an active carbon cap and trade program.¹⁸ Customers with SGIP technologies that result in net negative GHG emissions, who can verify the net negative GHG emissions and participate in cap and trade auctions, can receive monetary benefit from sale of banked carbon credits. The price of carbon credits in the California auction varies over time and with a number of factors, including the volume of carbon credits. Carbon prices have ranged from \$19.45 per metric tonne in July of 2012 to approximately \$12 per metric tonne in late 2014.¹⁹ In developing environmental cost adders for their avoided cost calculator, E3 estimated the price of carbon credits at \$12.5 per ton.²⁰ Due to the uncertainty in carbon prices, we use the same price for carbon traded in the cap and trade and avoided CO₂ cost adder (starting at \$13.98 per ton in 2014). We also assume the carbon price follows the projections adopted by E3 for CO₂ in their model.

Market Transformation Effects

The growth of a robust distributed generation and storage market in California creates additional competition among SGIP technologies and ideally results in lower SGIP system costs. In addition, other factors influence distributed generation and storage market transformation including streamlined policies and regulations, increased awareness of the distributed generation and storage technology benefits, and expanded technology supply infrastructure, among others. However, there is little quantitative information on the cost impacts associated with distributed generation and storage market transformation effects. This SGIP Cost Effectiveness Study has a complementary SGIP Market Transformation Study, which is examining factors influencing distributed generation and storage market transformation in California. The intent is to use the 2014 SGIPce model to compare SGIP costs with and without factors important to market transformation. However, for the purposes of this cost effectiveness study, market transformation effects are assumed to be quantified through reductions in SGIP system costs as projected by SGIP technology learning curves.

¹⁷ Net negative CO₂ emissions refers to the difference in CO₂ emissions generated by utility-based electricity minus the CO₂ generated by the DER system, which in this case includes methane captured that would otherwise be vented to the atmosphere. Additional treatment of this subject can be found in the 2013 SGIP Impact Evaluation Report (pending release).

¹⁸ California Air Resources Board, “Cap-and-Trade Program,” website. See: <http://www.arb.ca.gov/cc/capandtrade/capandtrade.htm>

¹⁹ Prices taken from California Carbon Dashboard. See: <http://calcarbondash.org/>

²⁰ E3 for the CPUC, Methodology and Forecast of Long-Term Avoided Costs for the Evaluation of California Energy Efficiency Programs, October 2004, pgs 88-89.



Tax Credits and Depreciation

State tax savings incorporate taxable operating costs, depreciation benefits, and equity and financing cost evaluated at the state corporate tax rate (9.3% for residential and 8.84% for the non-residential segment).

Federal ITC is treated at technology-specific values (specified in Section 4). Federal tax savings incorporate program rebates, taxable operating costs, depreciation benefits, and equity and financing cost evaluated at a federal corporate tax rate (35%).

Specific values for the ITC tax credits and depreciation for SGIP technologies are provided in Table 4-13 in Section 4.

Bill Credits and Exemptions

Certain SGIP technologies qualify for NEM. Participants with SGIP systems that qualify as NEM can receive bill credits from the IOUs when they export power to the grid. This export occurs when the power generated from the NEM system exceeds the energy needs of the site at the time of production over a 12-month billing cycle. In general, NEM is limited in California to solar, wind, fuel cell, and biogas systems smaller than 1 MW in capacity.²¹ Because SGIP technologies evaluated in this study are typically larger than 1 MW in capacity, we do not take into account NEM bill credits.

SGIP technologies of certain sizes and fuel by renewable resources can be exempt from departing load or charges (i.e., non-bypassable charges). A list of the SGIP technologies exempted from non-bypassable charges is provided in Table 4-14 in Section 4. For these technologies, we do not assess these charges on the technologies when calculating participant costs.

Prior to 2011, SGIP systems in California were generally exempted by standby reservation fees and charges. However, those exemptions expired on June 1, 2011. IOUs now provide exemptions from standby fees to SGIP technologies based on several factors, including the ability to charge the same fees to customers with similar load shapes regardless of their use of a SGIP technology.²² Because of the uncertainty in how standby fee exemptions are handled, we assumed all SGIP generation-based technologies in this evaluation are subject to standby fees.²³

As noted earlier, due to the high uncertainty in interconnection costs, we are not able to treat interconnection costs or their exemption in this study.

²¹ CPUC website on NEM. See: <http://www.cpuc.ca.gov/PUC/energy/DistGen/netmetering.htm>

²² U.S. EPA, Combined Heat and Power Partnership website, "California Standby Charges." See: <http://www.epa.gov/chp/policies/policies/cacaliforniastandbyrates.html>

²³ We assumed stand-alone storage technologies are not subject to standby charges as they do not generate power.



Societal Total Resource Cost and Total Resource Cost Tests

The Societal Total Resource Cost (STRC) and Total Resource Cost (TRC) tests measure the net costs of SGIP technologies as resource options based on the total costs of the projects, including both the participants' and the utility's costs. The STRC and the TRC tests help to determine if society's total resources are improved using a technology or a group of technologies assembled as a program.

The Societal Benefit-Cost Ratio is based on the following equation:

$$\text{Societal Benefit-Cost Ratio} = \frac{\text{Societal Benefits}}{\text{Societal Costs}}$$

Societal Costs

Societal costs represent costs that are borne by society when the utilities implement the SGIP program and technologies. In some instances, these are the same costs incurred by participants (e.g., system costs, emission controls, O&M, etc.) and in other instances are the same costs borne by the PAs (e.g., Program Administration costs). Societal costs are listed in Table E-6.

TABLE E-6: SOCIETAL COSTS

Costs
Costs of SGIP system, interconnection, emission controls and offset purchases
Operation and maintenance, fuel, ongoing emission offset purchases
Program administration
Reliability costs (system cost of additional ancillary services/VAR support)
Removal costs (less salvage)
Utility interconnection

SGIP Costs

The STRC and the TRC tests include total resource costs for SGIP systems. Total resource costs include five elements: 1) equity investment; 2) financing costs; 3) operating and maintenance (O&M) costs, fuel costs (where applicable) and insurance costs; 4) environmental costs; and, 5) program administration costs, including marketing, measurement, and evaluation costs. We calculate these costs accordingly as:

$$\text{Societal Costs}_i = \text{Equity}_i + \text{Finance}_i + \text{O \& M Cost}_i + \text{EnvCost}_i + \text{AdminCost}_i$$

Equity Investment Costs

The initial equity investment costs (Equity_i) for SGIP technology *i* are assumed to be incurred at the start of the project or the program (when looking at collections of technologies in a portfolio). Equity costs assume a 60% equity investment. The values of the equity costs are derived from secondary sources and



are considered representative of SGIP customer site costs. Forecasts of system costs are based on learning curves. These will be the same equity investments used in the PCT.

Financing Costs

Financing costs (Finance_i) occur over the lifetime of the SGIP technology and are discounted back to present value by using the societal discount rate for the STRC and a private discount rate for the TRC. Finance costs assume a 40% debt financing of the SGIP system cost using the appropriate market segment interest rate and a finance period of 80% of the SGIP system life.

Based on directions provided in CPUC decision D.09-08-026²⁴ from August 20, 2009, the perspective of the STRC test differs from the TRC test in only the discount rate. The STRC test uses a societal discount rate that is generally lower than the private discount rate used in the TRC. The decision also specified that, for the STRC and the TRC, “federal tax incentives should be included if we define the relevant ‘society’ as California and the benefits of these incentives flows into California from federal taxpayers.”

In general, we use a societal discount rate of 5.06%. For residential applications, we assume a debt interest rate of 5.5%. For non-residential applications, we assume a debt interest rate of 75% (which is the discount rate used for the commercial sector within the TRC).

OPERATION AND MAINTENANCE AND FUEL COSTS

O&M Costs

O&M costs occur over the lifetime of the SGIP system. We assume the same value of O&M costs for the STRC and TRC as those developed in the PCT.²⁵ The O&M component of the costs (which includes the technology specific O&M costs) is given by:

$$O \ \& \ M_{Cost} \ i = \sum_{t=1}^T \frac{O \ \& \ M_{Cost} \ i_t}{(1 + d)^t}$$

For gas-fired SGIP applications, the yearly fuel cost component of O&M costs is given by:

$$Fuel_{Cost} \ i_t = \sum_{m=1}^{12} ThermsUse_{imt} \ AvCostGas_{imt}$$

where ThermsUse_{imt} is the monthly usage of natural gas for the DG application and AvCostGas_{mtis} the monthly commodity displaced cost of gas.²⁶

²⁴ CPUC, “Decision Adopting Cost-Benefit Methodology for Distributed Generation,” Decision D.09-08-026. See: http://docs.cpuc.ca.gov/word_pdf/FINAL_DECISION/105926.pdf

²⁵ Note that in the PCT, O&M costs are discounted to (t – 1) to reflect upfront costs borne by the participant, which is not the case for STRC or TRC.

²⁶ For commercial customers, the avoided cost of gas does not include the T&D or the environmental components. Commercial customers are assumed to be non-core gas customers and the utilities are not required to plan their distribution network for these customers. The environmental component of the avoided



Environmental Costs

Some SGIP systems can produce environmental pollutants such as CO₂, NO_x, or SO₂ by combusting fuel. The amount of environmental pollutants produced by the SGIP systems is technology-specific and a function of the quantity of electricity produced. Society bears the costs associated with offsetting air pollution from SGIP systems that are not required to control emissions below offset levels. The yearly environmental cost ($EnvCost_{it}$) associated with the production of electricity is given by:

$$EnvCost_{it} = (MWH\ Prod_{it})(EnvEmission_i)(EmissionCost_i)$$

MWHProd_{it} is the yearly electricity production for the SGIP technology, EnvEmission_i is the pounds of pollutant produced per MWh of electricity produced, and EmissionCost_i is the yearly cost per pound of pollutant produced to offset the pollution. We assume cost of emissions based on the same values used by E3 in their avoided cost model for the environmental adders.²⁷

PROGRAM ADMINISTRATION COSTS

Program and administrative costs are incurred each year for design, operation, and evaluation of SGIP programs. Program and administrative costs are derived from reported SGIP administrative and evaluation costs.²⁸ We place them on a \$/kW basis using the installed capacities of the SGIP projects divided by the total program administration expenses reported to the CPUC on an annual basis. This average PAC cost per kW installed is then applied to each of the evaluated SGIP technologies.

RELIABILITY COSTS

In some instances, high growth in SGIP technologies may increase the need for ancillary services. For example, the California Independent System Operator (CAISO) has expressed concern that high penetration of customer-sited solar PV systems could lead to a need for fast-ramping generation.²⁹ However, SGIP systems currently evaluated in this study are subject to standby fees and are at relatively low penetration levels. As such, we assume that additional power and voltage support needs are addressed by the participant and not borne by society. At high penetration levels of SGIP, this assumption may have to be addressed.³⁰

costs is not included because each technology creates a unique environmental signature that is incorporated in a separate component.

²⁷ E3 assumed prices for NO_x, PM-10, and CO₂ based on either the cost to offset these emissions (e.g., NO_x and PM-10) or on the price at which banked emissions are sold through cap and trade (e.g., CO₂). See: E3 for the CPUC, Methodology and Forecast of Long-Term Avoided Costs for the Evaluation of California Energy Efficiency Programs, October 2004.

²⁸ CPUC, SGIP Statewide Budget Report. See: https://www.selfgenca.com/budget_public/statewide

²⁹ CAISO, Fast Fact: What the duck curve tells us about managing a green grid, from https://www.caiso.com/Documents/FlexibleResourcesHelpRenewables_FastFacts.pdf

³⁰ There is also reason to believe that additional reliability costs from DER will be addressed through the ongoing CPUC-led distribution resources plan proceedings.



SGIP SYSTEM REMOVAL COSTS

SGIP system removal costs could be a cost to society in those instances where removal of a SGIP system was not paid for by a participant. If site remediation is required, this could represent a significant cost. However, due to the small foot print of most SGIP technologies, there is a low likelihood of site remediation occurring with any frequency. Consequently, as with in the PCT, we assume SGIP system removal costs are negligible.

UTILITY INTERCONNECTION COSTS

As noted in the discussion of interconnection costs in the PCT, there is significant uncertainty in utility interconnection costs. Consequently, we do not treat utility interconnection costs in the STRC or TRC texts.

Societal Benefits

SGIP systems benefit society in a number of ways, including savings associated with reduced use of congested transmission and distribution systems; avoided fuel consumption, avoided air pollution emissions, increased reliability, and growth in new competitive markets. Table E-7 is a listing of societal benefits associated with SGIP technologies.

TABLE E-7: SOCIETAL BENEFITS

Benefits
Avoided Generation Related Costs
- Avoided Line Losses
- Avoided purchase of energy commodity and Resource Adequacy costs
- Avoided T&D costs (T&D Investment Deferrals)
- Avoided emissions (CO ₂ , NO _x , and Particulate Matter Emissions)
- Avoided transportation of natural gas due to CHP systems
Market transformation effects
Reliability benefits (both system and customer ancillary services/VAR support)
Tax credits/depreciation

AVOIDED GENERATION RELATED COSTS

The STRC includes a variety of benefits characterized as avoided costs or avoided cost adders, including avoided generation costs, avoided T&D costs, line loss reductions, a reliability adder, an environmental adder, waste heat utilization benefits, and tax credits and depreciation. For many of these benefits, we use benefit values derived from avoided costs developed by E3. The environmental adder within the avoided cost study attributes a monetary value to the reduction in carbon, oxides of nitrogen (NO_x), and particle matter smaller than 10 microns (PM₁₀) that results from the reduction in electricity produced and purchased from conventional electricity grid resources.

The societal benefits associated with individual technologies (SocietalBenefits_i) are estimated by:



$$SocietalBenefits_i = AvoidedElectricCosts_i + TaxBenefits_i + WasteHeatBenefits_i$$

AVOIDED ELECTRICITY COSTS

Avoided electricity costs are those costs typically associated with generation and transfer of electricity from utility generation plants. These costs are avoided by the utility if electricity is generated by alternative sources, such as SGIP located at customer sites. A formal definition of avoided costs comes from the Federal Energy Regulatory Commission (FERC), which defines avoided costs as “the incremental costs of electric energy, capacity, or both, which, but for the purchase from the qualifying facility (QF), such utility would generate itself or purchase from another source.”³¹ Avoided costs are different from electricity bill savings, which occur on the customer side of the meter. Avoided costs include the avoided cost of the utility generating electricity and transmitting it along the T&D system. The avoided costs include the environmental costs associated with generating the electricity and the energy needed to ensure electricity system reliability. These avoided costs represent benefits to society because they are costs that would otherwise be borne by the utilities and society in general. In addition to the avoided utility cost, we also include taxes that would have been paid for utility generation and distribution system upgrades.

We define $AvoidedElectricCosts_i$ to represent the avoided electric costs associated with technology i , $TaxBenefits_i$ are the tax benefits for technology i , and $WasteHeatBenefits_i$ reflects total waste heat benefits associated with technology i .

Because we use a levelized cost basis in calculating test results, we calculate avoided electric costs on an annual basis over the assumed lifetime of the technology. We discount the costs back to present value using a discount rate. For the STRC, the discount rate is the societal discount rate. In this case, avoided electric costs are calculated as follows:

$$AvoidedElectricCosts_i = \sum_{t=0}^T \frac{AvoidedElectricCosts_{it}}{(1+d)^t}$$

where t denotes the year in question, T is the lifetime of the technology, and d is a societal discount rate for the STRC test and a private discount rate for the TRC test.³² The symbol Σ is a summation sign that in this case means “add all the avoided electric costs starting from year zero up through the lifetime T of the technology.”

³¹ FERC. “Order Granting Clarification and Dismissing Rehearing.” 133 FERC ¶ 61,059, Docket EL10-64-001 (CPUC) and Docket EL10-66-001 (SCE, PG&E, and SDG&E Issued October 21, 2010. See: <http://elibrary.ferc.gov/idmws/common/OpenNat.asp?fileID=12468361>.

³² The test differs from the STRC test in the use of a private discount rate instead of the societal discount rate.



For each technology, we calculate annual avoided electric costs at each hour of the year and at a regional level.³³ We then sum the avoided electric costs over regions r (inland or coastal) and hours h to create annual values for each technology:

$$AvoidedElectricCosts_{it} = \sum_{r=1}^R \sum_{h=1}^{8760} \Delta kWh_{irh} AvCost_{irht}$$

Note that ΔkWh_{irh} is the amount of electricity generated hourly by technology i in region r , and $AvCost_{irht}$ is the avoided electric cost per kWh in hour h in year t in region r for technology i . The regions used in the evaluation refer to a coastal and inland region for each utility. We use hourly energy impacts by technology and region to be applied to the relevant hourly generation profiles of avoided generation costs. The hourly impacts are derived from metered hourly generation load profiles developed by Itron using existing SGIP sites. The hourly avoided cost rates include avoided costs of generation ($AvGCost_{hrt}$), avoided cost of T&D ($AvTDCost_{hrt}$), an environmental adder that varies across technology ($EnvAdd_{ihrt}$), and a reliability adder ($ReAdd_{hrt}$). Avoided generation costs take into account line losses on displaced purchases.

Waste Heat Benefits

For CHP systems, waste heat recovery can act to reduce the amount of natural gas procured and transported by utilities. Waste heat benefits are computed as the present value of annual values:

$$WasteHeatBenefits_i = \sum_{t=1}^T \frac{WasteHeatBenefits_{it}}{(1+d)^t}$$

Annual values of waste heat benefits are calculated using:

$$WasteHeatBenefits_{it} = \sum_{m=1}^{12} DisTherms_{im} AvGasCost_{mt}$$

In these CHP applications, $DisTherms_{im}$ is the gas consumption displaced by technology i in month m and $AvGasCost_{mt}$ is the avoided cost of gas in month m and year t . We use gas transportation tariffs in estimating the avoided costs from utilities not having to transport gas to CHP sites.

MARKET TRANSFORMATION EFFECTS

Development of a robust distributed generation and storage market has a number of benefits to society, including increased competition, with commensurate increase in innovation and resulting increased cost effectiveness.³⁴ However, there is limited quantitative information on the effects of market

³³ The regional level was defined as coastal and inland for each utility. The E3 avoided costs were aggregated into inland and coastal values using the past SGIP-installed generation as weights.

³⁴ Duke, R. and Kammen, D., "The Economics of Energy Market Transformation Programs," The Energy Journal, April 1999.



transformation of distributed generation and storage. We treat market transformation benefits in the TRC and STRC as reduced costs of SGIP technologies in the future based on technology-specific learning curves.

RELIABILITY BENEFITS

SGIP systems may improve overall electrical system reliability under certain circumstances. For example, because they are dispersed throughout the electricity system, there is less chance that all SGIP systems will go offline at the same time. When operated in parallel to the grid or if configured into microgrids, SGIP systems can provide utility customers with power even when the grid is down. We use the reliability adder from the E3 electrical avoided cost model in valuing reliability benefits from SGIP technologies.

TAX CREDITS AND DEPRECIATION

Tax benefits include the federal ITC, potential tax refunds associated with the flow of investment and operating costs, and depreciation tax benefits. These benefits are computed as the present value of annual values:

$$TaxBenefit_s_i = \sum_{t=1}^T \frac{Investment_i + TaxCredit_i + Federal\ Re\ fund_i + Depreciation_i}{(1+d)^t}$$

The ITC is a first-year credit dependent on the technology and the cost of the technology. The depreciation tax benefit is also dependent on the type of technology and the cost of the technology. Depending on the type of technology, the depreciation tax credit may be spread over as few as five years or extended over 15 years. The federal tax refund is calculated yearly based on corporate tax rates, investment and financing costs, and operating and maintenance expenses.

Program Administrator Cost Test

The PAC test determines how the utility’s revenue requirements are changed due to the utility administering the SGIP program. In the PAC test, revenue shifts are viewed as a transfer payment between participants and all ratepayers. Consequently, though a shift in revenue affects rates, it does not affect revenue requirements. Revenue requirements are defined as the difference between the net avoided marginal energy and capacity costs and program costs.

The PAC Benefit-Cost Ratio is given by:

$$PA\ Benefit-Cost\ Ratio = PA\ Benefits/PA\ Costs$$

Program Administrator Costs

PAC costs are the program costs incurred by the administrator, the incentives paid to the customers, and increased fuel costs for the periods in which load is increased plus program administration costs.



Program administration costs include marketing, measurement, and evaluation costs, and customer dropout. PA costs also include losses in revenue from exemptions provided to participants from certain charges (such as standby fees) or losses in revenue from reduced transmission or distribution charges. PA costs are listed in Table E-8:

TABLE E-8: PROGRAM ADMINISTRATOR COSTS

Costs
Increased Costs
- Utility Rebates/Incentives (non-NEM)
- Increased IOU fuel transportation costs for gas-fired DG
- Program administration
- Reliability costs (system cost of additional ancillary services/VAR support)
- Utility interconnection
Reduced Revenues
- NEM costs
- Reduced revenue from standby charge exemptions
- Reduced transmission, distribution, and non-fuel generation revenues

Incentive Costs

Incentive costs are specific to each SGIP technology and represent incentives paid to participants as either performance based incentives (PBI) or up-front incentives. PBI is provided to all SGIP technologies 30 kW or larger in capacity. In accordance with SGIP Handbook rules, 50% of the available PBI is provided up front to the participant and the remaining 50% is provided equally over the next five years. For SGIP technologies smaller than 30 kW in capacity, all of the incentive is paid up front. The incentives are modeled as PBI or up-front incentives consistent with the SGIP Handbook rules. Incentives also decline over time in accordance with Handbook rules and these reductions in incentives are taken into account in the calculations. Incentive values by technology are specified in Section 4.

Utility Fuel Costs

Running and operating a gas-fired SGIP system requires additional natural gas from the gas utility and, as a result, a higher transportation charge. In California, gas-fired SGIP within the residential sector leads to higher natural gas fuel transportation costs within the PAC test. The increased gas transportation costs were valued according to gas transportation tariff rates for each IOU. The model does not incorporate higher transportation costs for commercial customers within the PAC test because these customers are modeled as wholesale gas (non-core) customers and gas transportation costs were set to zero.

Administration Costs

PAC administration costs include such items as program planning and design, marketing, and measurement and evaluation. They were derived from the installed kW of SGIP projects divided by the total program administration expenses reported to the CPUC on an annual basis. This average PAC cost per kW installed was then applied to the technology being installed and on an energy basis (\$/MWh).

**Reliability Costs**

As indicated in the STRC and TRC tests, we do not treat increased reliability costs due to low penetration levels of SGIP and with the understanding that these costs may be recovered by standby charges.

Utility Interconnection Costs

As in the STRC and TRC tests, given the uncertainty of interconnection costs, we also do not treat interconnection costs in the PAC test.

NEM Costs

SGIP technologies that qualify as NEM systems are eligible to receive bill credits and can be exempt from certain departing load charges. We treat increased costs or loss of revenue to PAs due to SGIP technologies that are net energy metered in accordance with the exemptions described in Section 4 (in particular, see Table 4-14 for a list of SGIP technologies exempt from departing load charges).

Standby Charge Exemptions

In accordance with our treatment of standby charge exemptions in the PCT, we assume all SGIP generation technologies are subject to standby charges.³⁵ As a result, there is no loss of revenue to PAs due to standby charge exemptions.

Reduced T&D and Non-Fuel Generation Revenues

Similar to the treatment of reliability costs, there is high uncertainty in how reduced T&D revenues will be treated. The CPUC's Distributed Resources Plan proceeding allows for development of a tariff that provides equitable treatment of SGIP costs to all ratepayers. However, that tariff is still under development. As a result, we do not treat loss in revenue from reduced T&D and non-fuel generation in the PAC test.

Program Administrator Benefits

PA benefits include electricity avoided cost savings, increased reliability, reductions in T&D and CHP gas avoided cost savings. PA benefits are listed in Table E-9.

TABLE E-9: PROGRAM ADMINISTRATOR BENEFITS

Benefits
Avoided Electricity Costs
- Avoided Line Losses
- Avoided purchase of energy commodity and Resource Adequacy costs
- Avoided T&D costs (T&D Investment Deferrals)
- Reliability benefits (both system and customer ancillary services/VAR support)
CHP plant-specific benefits

³⁵ As indicated in the PCT discussion, stand-alone storage systems are not treated as being subject to standby fees as they are not generating power.



The PA benefits associated with individual technologies (ProgramAdministratorBenefits_i) are calculated by:

$$ProgramAdministratorBenefits_i = AvoidedElectricCosts_i + WasteHeatBenefits_i$$

AvoidedElectricCosts_i represents the avoided electric costs associated with technology i and WasteHeatBenefits_i reflects the utilities gas costs associated with waste heat benefits from technology i.

Avoided Electricity Costs

Avoided electricity costs include avoided generation costs, avoided T&D costs, reduced line losses, reliability net benefits, and environmental benefits due to reduced grid-based generation. We use values for each of these components from the E3 avoided cost model.

Avoided electric costs for each technology are developed on an annual basis for the assumed lifetime of the technology using hourly technology profiles:

$$AvoidedElectricCosts_{it} = \sum_{r=1}^R \sum_{h=1}^{8760} \Delta kWh_{irh} AvCost_{irht}$$

ΔkWh_{irh} is the hourly electricity output of technology i in region r, and $AvCost_{irht}$ is the avoided electric cost per kWh in hour h in year t in region r for technology i.

The hourly avoided cost rates include avoided costs of generation ($AvGCost_{hrt}$), avoided cost of T&D ($AvTDCost_{hrt}$), an environmental adder that varies across technology ($EnvAdd_{ihrt}$), and a reliability adder ($ReAdd_{hrt}$). Avoided generation costs take into account line losses on displaced purchases.

$$AvCost_{irht} = AvGCost_{hr} + AvTDCost_{hrt} + EnvAdd_{ihrt} + ReAdd_{hrt}$$

The avoided electric costs are discounted back to present value using:

$$AvoidedElectricCosts_i = \sum_{t=0}^T \frac{AvoidedElectricCosts_{it}}{(1+d)^t}$$

Waste Heat Benefits:

PAs benefit from waste heat recovered by CHP systems, which avoids gas purchases. Waste heat benefits are calculated on an annual basis using monthly gas consumption:

$$WasteHeatBenefits_{it} = \sum_{m=1}^{12} DisTherms_{im} AvGasCost_{mt}$$



$DisTherms_{im}$ is the gas consumption displaced by technology i in month m and $AvGasCost_{mt}$ is the avoided cost of gas in month m and year t . Commercial and government customers are modeled as non-core gas customers; the utility is not the provider of gas to these customers. Commercial and government customers are assumed to purchase their gas on the wholesale market. For these customers, the gas avoided cost savings are zero. Residential SGIP technologies are not modeled as CHP technologies.



Join us in creating a more **resourceful world**.
To learn more visit itron.com/consulting

CONSULTING AND ANALYSIS

330 Madson Pl.
Davis, CA 95618

Phone: 1.800.635.5461